

**NEW WEBSHOP
ONLINE NOW!**

shop.fath24.de/en

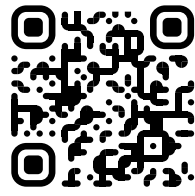

LEAN 4.0

EDITION 2.3 | EN

VISUAL MANAGEMENT

Container Labeling **1**

Shelf Labeling **2**

Floor Markings **3**

Stickers **4**

Sign Frames **5**

Inserting Systems **6**

Visual Boards **7**

MATERIAL FLOW

Material Transport **8**

Material Supply **9**

FATH GmbH | LEAN 4.0

Edition 2.3
English

FATH

LEAN 4.0



SOLUTIONS FOR INDUSTRIAL ECOSYSTEMS

1

ENGINEERING COMPONENTS

- Components for Aluminium Profile Systems
- Workplace Components
- Floor Elements
- Roller Rails

2

INDUSTRIAL HARDWARE

- Components for Server and Switch Cabinet Construction

3

SHOPFLOOR & INTRALOGISTICS

- Floor Markings
- Shelf and Container Labeling
- Material Flow and Material Supply
- Visual Boards



4

WAREHOUSE AND INTRALOGISTICS AUTOMATION

- Components for Belt Conveyors
- Components for Roller Conveyors
- Flowsort Modular Sortation Systems
- Roller Tracks

5

MECHATRONICS

- TANlock Smart Access Control



ecosystem.fath24.com

CONTENT OVERVIEW

Visual Management



Material Flow

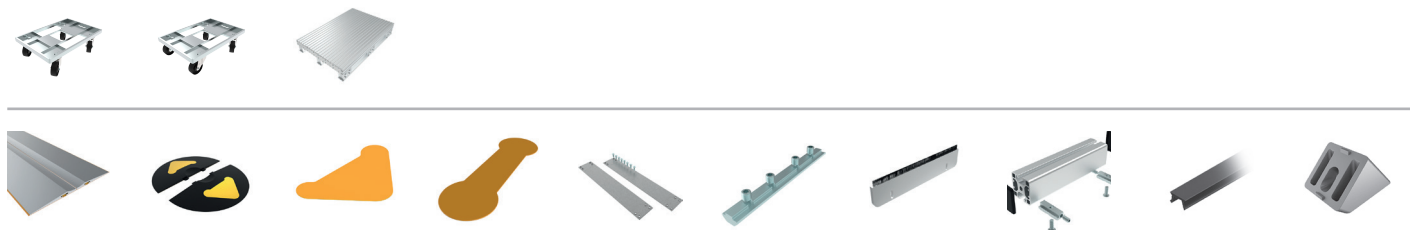



Container Labeling **1**



Shelf Labeling **2**



Floor Markings **3**

Stickers **4**



Sign Frames **5**

Inserting Systems **6**



Visual Boards **7**

Material Transport **8**

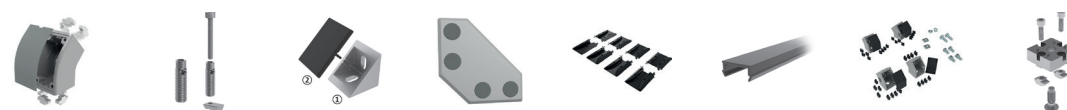

Material Supply **9**







VISUAL MANAGEMENT



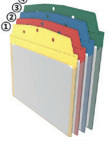

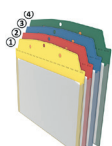
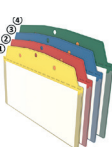
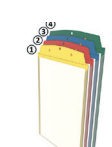



Container Labeling

1

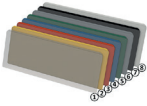
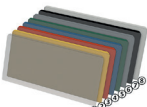
Container Labeling

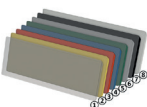
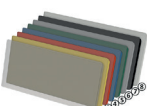
	Attached Visual Pocket DIN A5 Landscape - 8.3" x 5.8"	15
	Attached Visual Pocket 1/3 DIN A4 Portrait - 8.3" x 3.9"	16
	Attached Visual Pocket DIN A4 Portrait - 8.3" x 11.7"	17
	Self-adhesive Visual Pocket DIN A5 Landscape - 8.3" x 5.8"	18
	Self-adhesive Visual Pocket 1/3 DIN A4 Portrait - 8.3" x 3.9"	19
	Self-adhesive Visual Pocket DIN A4 Portrait - 8.3" x 11.7"	20
	Magnetic Visual Pocket DIN A5 Landscape - 8.3" x 5.8"	21
	Magnetic Visual Pocket 1/3 DIN A4 Portrait - 8.3" x 3.9"	22
	Magnetic Visual Pocket DIN A4 Portrait - 8.3" x 11.7"	23
	U-loop Steel Clamp for Visual Pocket	24

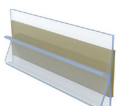
	Lattice Box Clip for Visual Pocket	25
	Plastic Pin for Visual Pocket	26
	Plastic Tie for Visual Pocket	27
	Top Open KANBAN Envelope 200 x 67 - 7.9" x 2.6"	31
	Top Open KANBAN Envelope 200 x 85 - 7.9" x 3.4"	32
	Top Open KANBAN Envelope 200 x 135 - 7.9" x 5.3"	33
	Side Open KANBAN Envelope 200 x 67 - 7.9" x 2.6"	34
	Side Open KANBAN Envelope 200 x 85 - 7.9" x 3.4"	35
	Side Open KANBAN Envelope 200 x 135 - 7.9" x 5.3"	36
	KANBAN Clip Document Holder 70 x 30 - 2.8" x 1.2"	37



Overhanging KANBAN Label Holder

38

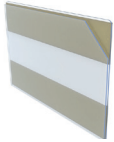

Self-adhesive KANBAN Label Holder

39

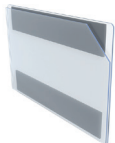

Magnetic KANBAN Label Holder

40

FATH

SUSTAINABLE: REUSABLE SHELF LABELING & CONTAINER LABELING

TIP



Sustainability and efficiency - how can they be reconciled?

Responsible use of resources should be a matter of course for all companies. This is a challenge for production and intralogistics, but with intelligent LEAN solutions for shelf and container labeling, you can easily achieve greater sustainability - while clever product features optimize work processes.

**Conserving resources through multiple use -
and with less expenditure**

**Discover additional functions online
and request a personal sample package:**

tip-container-labeling.fath24.com

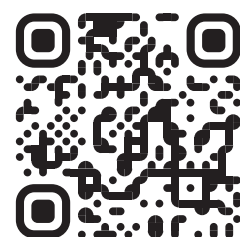



FATH

VISUAL POCKETS

Multi-use:

Label your warehouse reliably with FATH's versatile Visual Pockets



- Magnetic, reusable self-adhesive or attachable with accessories
- Scanner readable
- A wide variety of colors and formats
- Numerous attachment options
- Durable with reinforced header pieces
- Conserving resources through multi-use

HIGHLIGHTS

Made of durable plastic with a reinforced header, the Visual Pockets are available in the following versions: magnetic, reusable self-adhesive or attachable with accessories. Each version is available in four colors and three formats. You can use them to label all standard crates, boxes, and containers, whether they are made of plastic, metal, wood or glass. You can choose from numerous attachment accessories that are compatible with Euro boxes, plastic crates and trays, lattice boxes, SLCs, heavy load carriers, and many more. The front of the Visual Pocket is made of a transparent film while the back is made of a colored plastic. Thanks to the nature of the transparent film, a scanner can easily read the inserted documentation without it needing to be removed.

Sustainable labeling: Through the multiple use of **FATH** Visual Pockets, you can save on purchasing costs and at the same time the use of resources and the amount of waste will be reduced. In this way, the requirements for high efficiency and greater sustainability in production and logistics can be harmonized. The clever product features of the **FATH** Visual Pockets improve work processes - and they bring more sustainability to the industrial environment.

REUSABLE
ADHESIVE



Unique worldwide: Reusable Self-Adhesive Visual Pockets

This is new: **FATH**'s Visual Pockets are able to be reused again and again since the innovative adhesive retains its adhesion properties even after being detached. If a container needs to be re-labeled, the reusable self-adhesive **FATH** Visual Pocket can simply be removed. While conventional adhesives leave stubborn residues that need to be painstakingly removed, the new self-adhesive **FATH** products can be removed in one piece, easily and completely free of residue. Our adhesive remains adhered to the Visual Pocket and can be reattached elsewhere multiple times. This means that **FATH**'s self-adhesive Visual Pockets are also suitable for temporary labeling. That is both lean and sustainable.



FATH

Reusable Self-Adhesive Visual Pockets

An adhesive strip is attached to the back of the reusable self-adhesive Visual Pocket. Remove the liner from the double-sided adhesive strip, press the Visual Pocket onto a suitable surface and you're done. This version of the Visual Pockets is especially suitable for wood, glass, plastic and precious metal containers. The Industrial Adhesive compensates for unevenness and offers a high degree of adhesion on many load-bearing surfaces immediately after attachment.



1

Magnetic Visual Pockets

FATH's Magnetic Visual Pockets feature two welded-in neodymium magnets. They are suitable for attaching to all ferrous surfaces and are able to withstand strong vibrations thanks to strength of the neodymium magnets. Two individual magnets allow the Visual Pockets to be attached to round objects such as barrels and pumps. They can also remain firmly attached to metal wall paneling that is fluted or has a profiled surface.



Attached Visual Pockets

There are many accessories available to mount FATH's Attachable Visual Pockets. Brackets are attached through the punch holes in the Visual Pocket's reinforced header piece. The availability of different fastening options means Visual Pockets can be attached to almost any container – from SLCs and barrels through to drums and special load carriers.





FATH

Accessories



U-loop Steel Clamp for Visual Pocket
For films, thinner cardboard packaging, and outer packaging

Part #: 02011E02



Plastic Pin for Visual Pocket
For thicker cardboard packaging, foam, textiles, and plastic bags

Part #: 02011E04



Lattice Box Clip for Visual Pocket
For lattice boxes and steel cable for ceiling signage

Part #: 02011E03



Plastic Tie for Visual Pocket
For profiles, ducts, lattice boxes, and containers with handles

Part #: 02011E05

Versions

The Visual Pockets are available in the following versions

- Reusable Self-Adhesive
- Attachable with accessories
- Magnetic

Available in following formats:

- DIN A5 landscape
- 1/3 DIN A4 portrait
- DIN A4 portrait

Available in following colors:

- Yellow
- Red
- Blue
- Green



Would you like to learn more about **FATH** Visual Pockets?

visual-pocket.fath24.com

ATTACHED VISUAL POCKET DIN A5 LANDSCAPE - 8.3" X 5.8"

MODEL	For attachment
DESCRIPTION	Strong and durable visible pocket for hanging or inserting, with pre-punched hole pattern for attaching to various load carriers using optional accessories; Tear-resistant and stretchable transparent foil with restoring capacity, scanner-compatible
MATERIAL	Plastic PVC
COLOR	Yellow, red, blue, green
PACK QUANTITY	10 pieces
TIP	Compatible U-loop Steel Clamp see 02011E02; Compatible Lattice Box Clip see 02011E03; Compatible Plastic Pin see 02011E04; Compatible Plastic Tie see 02011E05

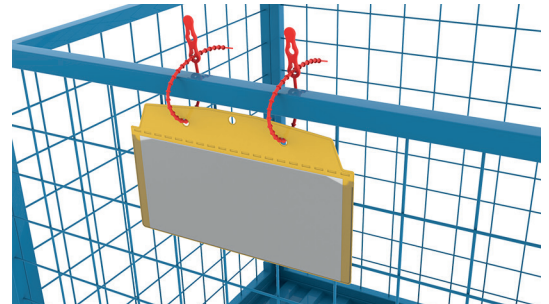
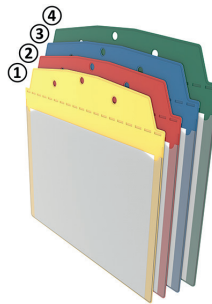
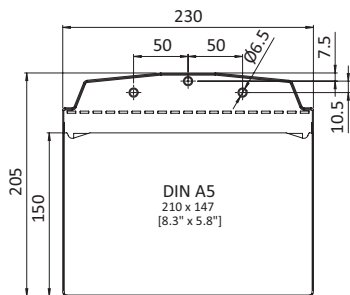
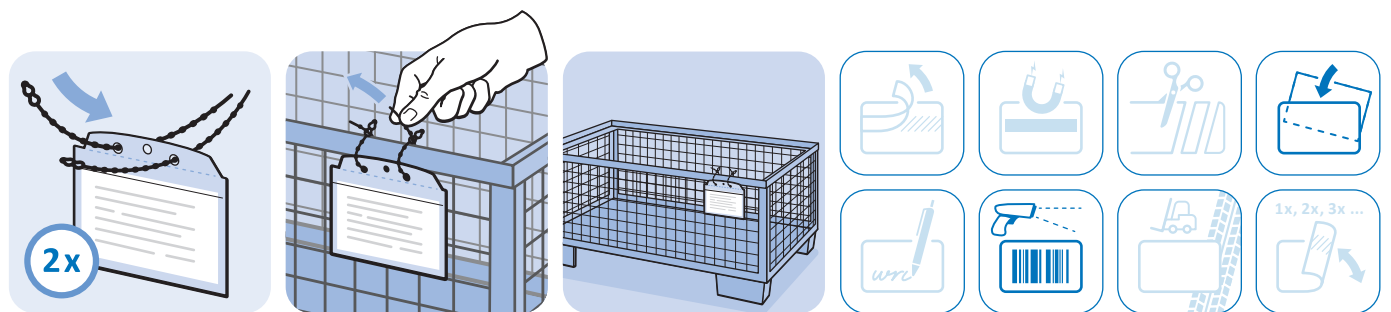

Fig.	Color	Weight [g]	Part #
①	Yellow ≈ RAL 1018	27.6	02011A5LH15
②	Red ≈ RAL 3020	27.6	02011A5LH31
③	Blue ≈ RAL 5017	27.6	02011A5LH55
④	Green ≈ RAL 6016	27.6	02011A5LH63



ATTACHED VISUAL POCKET 1/3 DIN A4 PORTRAIT - 8.3" X 3.9"

MODEL	For attachment
DESCRIPTION	Strong and durable visible pocket for hanging or inserting, with pre-punched hole pattern for attaching to various load carriers using optional accessories; Tear-resistant and stretchable transparent foil with restoring capacity, scanner-compatible
MATERIAL	Plastic PVC
COLOR	Yellow, red, blue, green
PACK QUANTITY	10 pieces
TIP	Compatible U-loop Steel Clamp see 02011E02; Compatible Lattice Box Clip see 02011E03; Compatible Plastic Pin see 02011E04; Compatible Plastic Tie see 02011E05

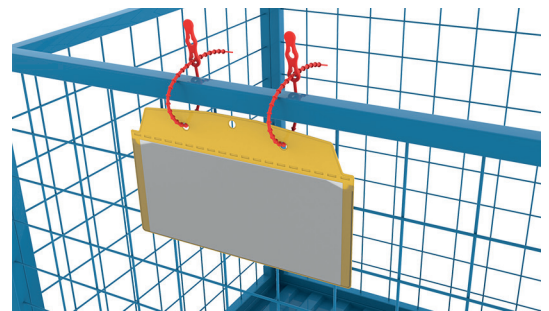
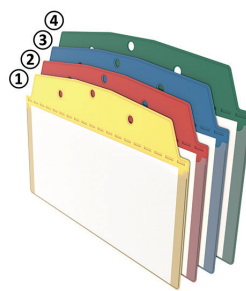
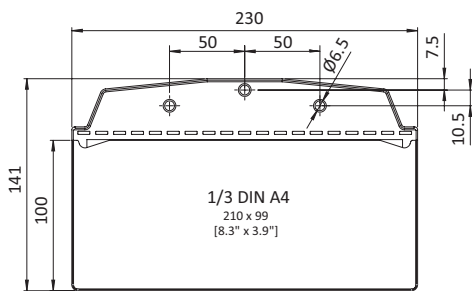
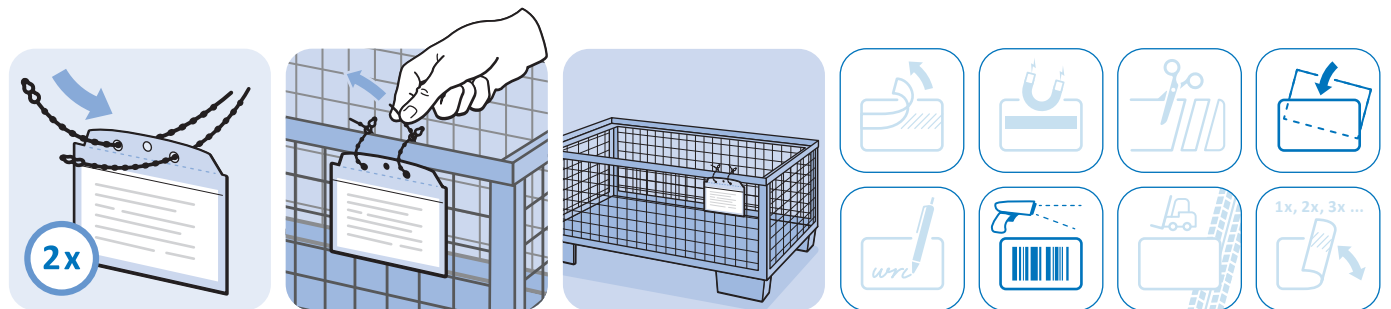

Fig.	Color	Weight [g]	Part #
①	Yellow ≈ RAL 1018	12.6	02011A1/3H15
②	Red ≈ RAL 3020	12.6	02011A1/3H31
③	Blue ≈ RAL 5017	12.6	02011A1/3H55
④	Green ≈ RAL 6016	12.6	02011A1/3H63



ATTACHED VISUAL POCKET DIN A4 PORTRAIT - 8.3" X 11.7"

MODEL	For attachment
DESCRIPTION	Strong and durable visible pocket for hanging or inserting, with pre-punched hole pattern for attaching to various load carriers using optional accessories; Tear-resistant and stretchable transparent foil with restoring capacity, scanner-compatible
MATERIAL	Plastic PVC
COLOR	Yellow, red, blue, green
PACK QUANTITY	10 pieces
TIP	Compatible U-loop Steel Clamp see 02011E02; Compatible Lattice Box Clip see 02011E03; Compatible Plastic Pin see 02011E04; Compatible Plastic Tie see 02011E05

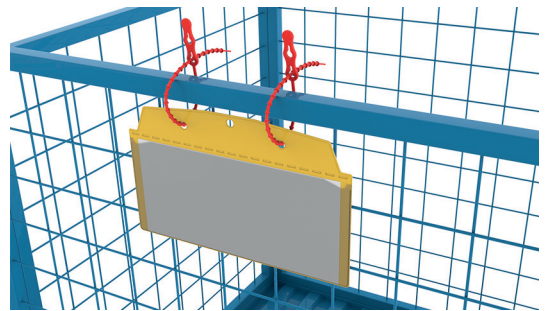
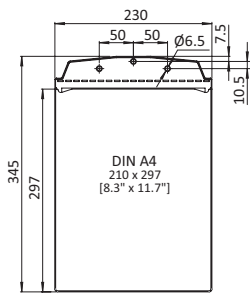
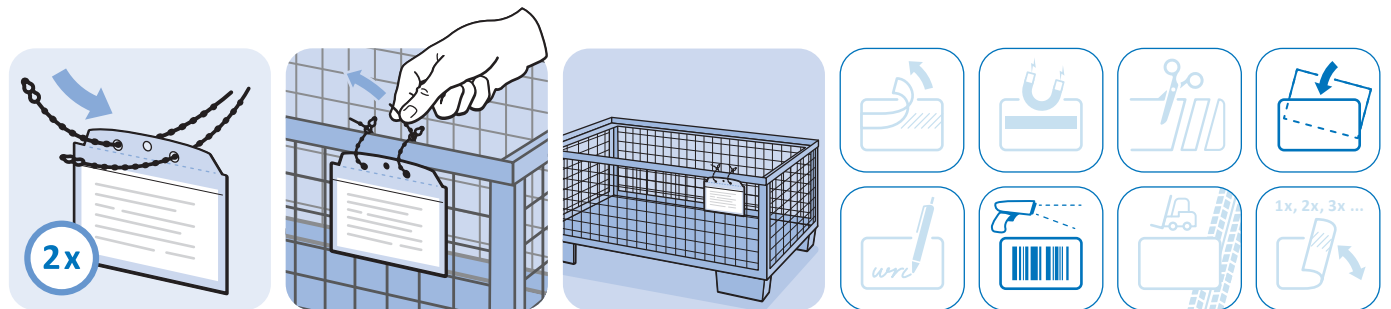

Fig.	Color	Weight [g]	Part #
①	Yellow ≈ RAL 1018	51.0	02011A4PH15
②	Red ≈ RAL 3020	51.0	02011A4PH31
③	Blue ≈ RAL 5017	51.0	02011A4PH55
④	Green ≈ RAL 6016	51.0	02011A4PH63



SELF-ADHESIVE VISUAL POCKET DIN A5 LANDSCAPE - 8.3" X 5.8"

MODEL	Self-adhesive (multi-use)
DESCRIPTION	Strong and durable visible pocket for flexible adhesion even on uneven surfaces, removable without leaving any residue, reusable on supporting surfaces thanks to multi-use properties; Tear-resistant and stretchable transparent foil with restoring capacity, scanner-compatible
MATERIAL	Visual Pocket: Plastic PVC Adhesive strip: PE foam, reusable
COLOR	Yellow, red, blue, green
PACK QUANTITY	10 pieces

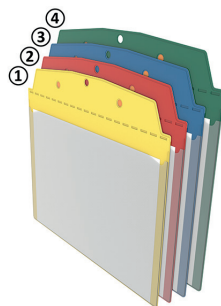
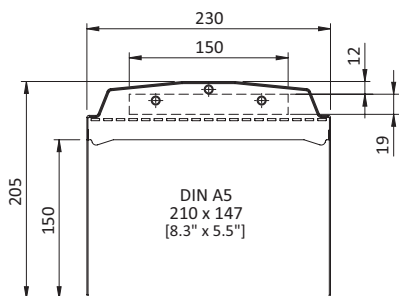

Fig.	Color	Weight [g]	Part #
①	Yellow ≈ RAL 1018	28.0	02011A5LA15
②	Red ≈ RAL 3020	28.0	02011A5LA31
③	Blue ≈ RAL 5017	28.0	02011A5LA55
④	Green ≈ RAL 6016	28.0	02011A5LA63



SELF-ADHESIVE VISUAL POCKET 1/3 DIN A4 PORTRAIT - 8.3" X 3.9"

MODEL	Self-adhesive (multi-use)
DESCRIPTION	Strong and durable visible pocket for flexible adhesion even on uneven surfaces, removable without leaving any residue, reusable on supporting surfaces thanks to multi-use properties; Tear-resistant and stretchable transparent foil with restoring capacity, scanner-compatible
MATERIAL	Visual Pocket: Plastic PVC Adhesive strip: PE foam, reusable
COLOR	Yellow, red, blue, green
PACK QUANTITY	10 pieces

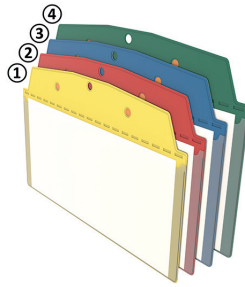
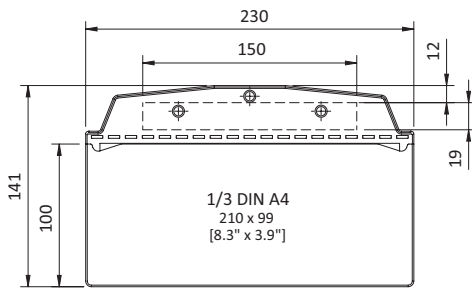
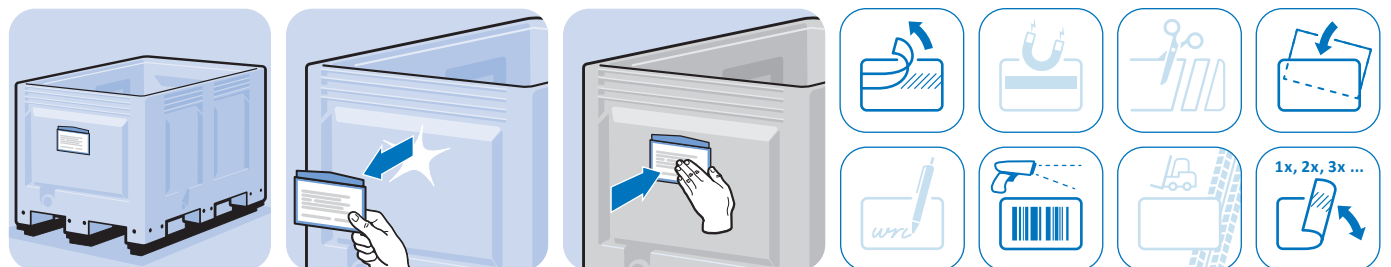

Fig.	Color	Weight [g]	Part #
①	Yellow ≈ RAL 1018	13.0	02011A1/3A15
②	Red ≈ RAL 3020	13.0	02011A1/3A31
③	Blue ≈ RAL 5017	13.0	02011A1/3A55
④	Green ≈ RAL 6016	13.0	02011A1/3A63



1

SELF-ADHESIVE VISUAL POCKET DIN A4 PORTRAIT - 8.3" X 11.7"

MODEL	Self-adhesive (multi-use)
DESCRIPTION	Strong and durable visible pocket for flexible adhesion even on uneven surfaces, removable without leaving any residue, reusable on supporting surfaces thanks to multi-use properties; Tear-resistant and stretchable transparent foil with restoring capacity, scanner-compatible
MATERIAL	Visual Pocket: Plastic PVC Adhesive strip: PE foam, reusable
COLOR	Yellow, red, blue, green
PACK QUANTITY	10 pieces

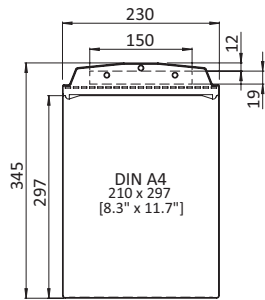
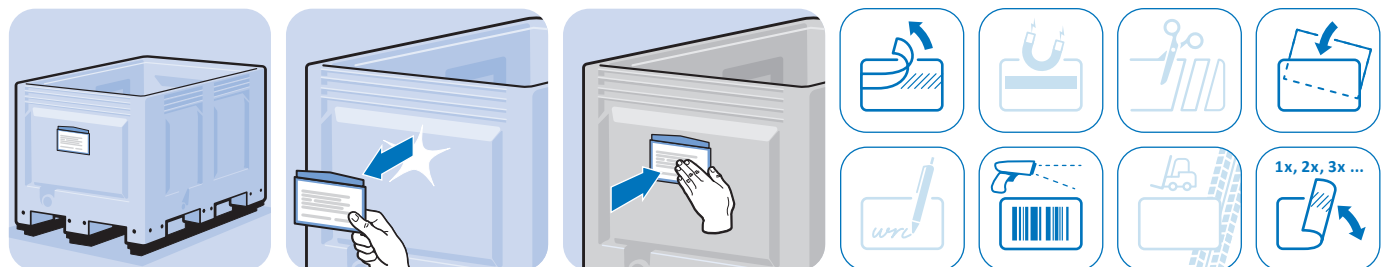

Fig.	Color	Weight [g]	Part #
①	Yellow ≈ RAL 1018	51.0	02011A4PA15
②	Red ≈ RAL 3020	51.0	02011A4PA31
③	Blue ≈ RAL 5017	51.0	02011A4PA55
④	Green ≈ RAL 6016	51.0	02011A4PA63



MAGNETIC VISUAL POCKET DIN A5 LANDSCAPE - 8.3" X 5.8"

MODEL	Magnetic (neodymium)
DESCRIPTION	Strong and durable visible pocket for magnetic attachment even on offset or round surfaces such as lattice boxes or drums, vibration and shock resistant on machines and during transportation thanks to the strong holding power of the high-performance neodymium magnets; Tear-resistant and stretchable transparent foil with restoring capacity, scanner-compatible
MATERIAL	Visual Pocket: Plastic PVC Magnets: Neodymium
COLOR	Yellow, red, blue, green
PACK QUANTITY	10 pieces

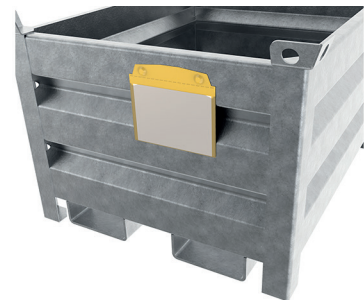
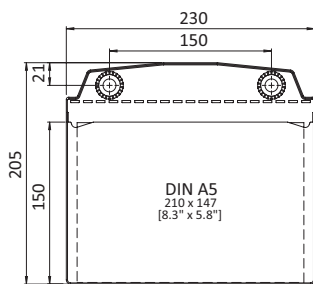
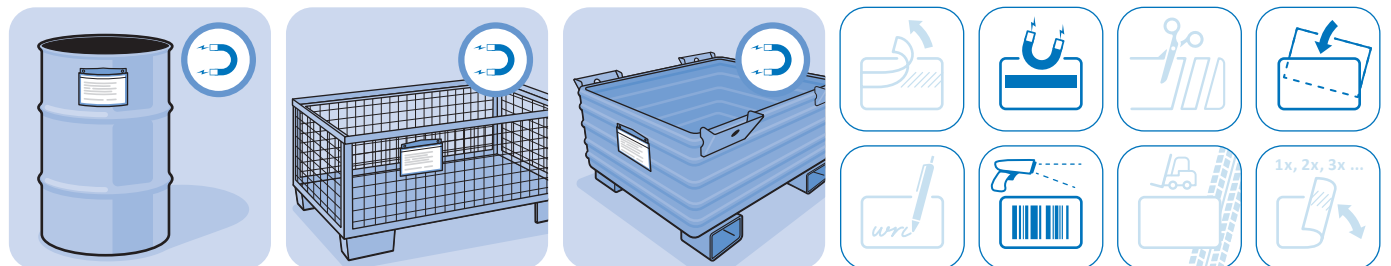

Fig.	Color	Weight [g]	Part #
①	Yellow ≈ RAL 1018	38.0	02011A5LM15
②	Red ≈ RAL 3020	38.0	02011A5LM31
③	Blue ≈ RAL 5017	38.0	02011A5LM55
④	Green ≈ RAL 6016	38.0	02011A5LM63



MAGNETIC VISUAL POCKET 1/3 DIN A4 PORTRAIT - 8.3" X 3.9"

MODEL	Magnetic (neodymium)
DESCRIPTION	Strong and durable visible pocket for magnetic attachment even on offset or round surfaces such as lattice boxes or drums, vibration and shock resistant on machines and during transportation thanks to the strong holding power of the high-performance neodymium magnets; Tear-resistant and stretchable transparent foil with restoring capacity, scanner-compatible
MATERIAL	Visual Pocket: Plastic PVC Magnets: Neodymium
COLOR	Yellow, red, blue, green
PACK QUANTITY	10 pieces

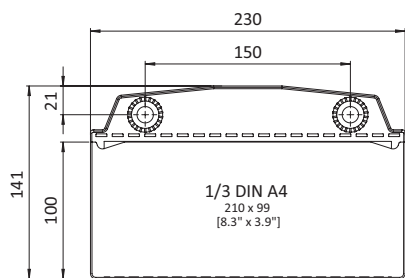
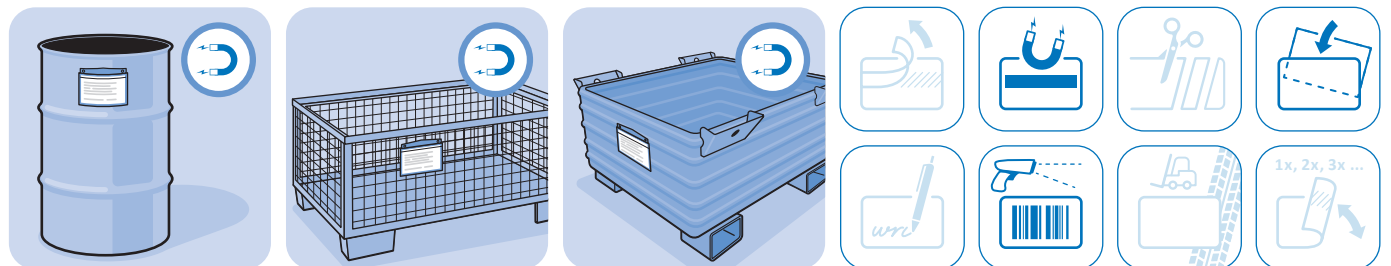

Fig.	Color	Weight [g]	Part #
①	Yellow ≈ RAL 1018	35.0	02011A1/3M15
②	Red ≈ RAL 3020	35.0	02011A1/3M31
③	Blue ≈ RAL 5017	35.0	02011A1/3M55
④	Green ≈ RAL 6016	35.0	02011A1/3M63



MAGNETIC VISUAL POCKET DIN A4 PORTRAIT - 8.3" X 11.7"

MODEL	Magnetic (neodymium)
DESCRIPTION	Strong and durable visible pocket for magnetic attachment even on offset or round surfaces such as lattice boxes or drums, vibration and shock resistant on machines and during transportation thanks to the strong holding power of the high-performance neodymium magnets; Tear-resistant and stretchable transparent foil with restoring capacity, scanner-compatible
MATERIAL	Visual Pocket: Plastic PVC Magnets: Neodymium
COLOR	Yellow, red, blue, green
PACK QUANTITY	10 pieces

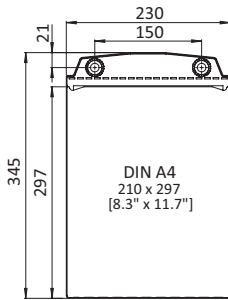
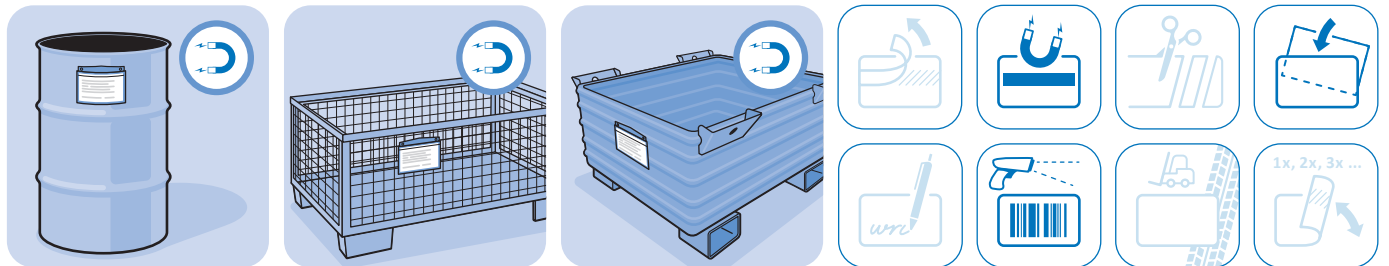

Fig.	Color	Weight [g]	Part #
①	Yellow ≈ RAL 1018	54.0	02011A4PM15
②	Red ≈ RAL 3020	54.0	02011A4PM31
③	Blue ≈ RAL 5017	54.0	02011A4PM55
④	Green ≈ RAL 6016	54.0	02011A4PM63



1

U-LOOP STEEL CLAMP FOR VISUAL POCKET

MODEL	For hanging up on foils and meshes
DESCRIPTION	Universal U-loop for hanging up attached visual pockets in foils or on rods of lattice boxes and mesh panels
MATERIAL	Steel
SURFACE	Zinc plated
PACK QUANTITY	100 pieces
TIP	Compatible attached visual pockets see 02011A5LH15, 02011A4PH15 and 02011A1/3H15

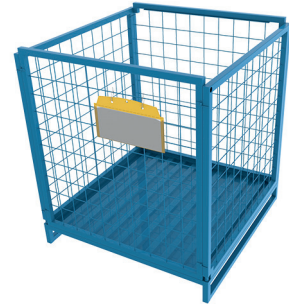
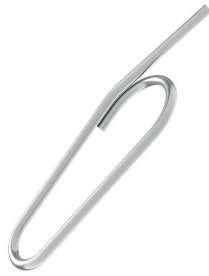
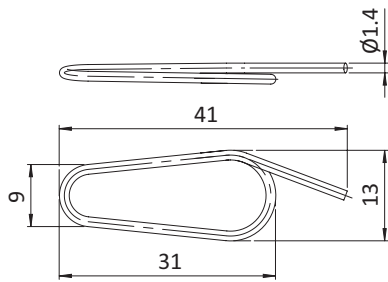

Weight [g]

Part #

1.0

02011E02

LATTICE BOX CLIP FOR VISUAL POCKET

MODEL	For clamping on lattice boxe frames
DESCRIPTION	Clip with excellent grip to clip-on attached visual pockets to the frame of lattice boxes
MATERIAL	Plastic PVC
COLOR	Transparent
PACK QUANTITY	100 pieces
TIP	Compatible attached visual pockets see 02011A5LH15, 02011A4PH15 and 02011A1/3H15

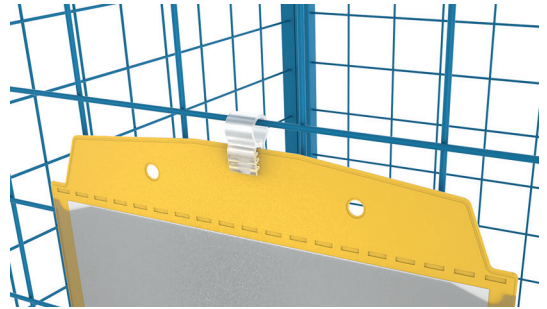
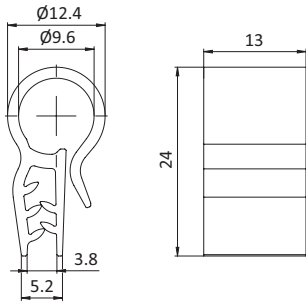

1

Weight [g]	Part #
2.0	02011E03

PLASTIC PIN FOR VISUAL POCKET

MODEL	For attaching on cartons
DESCRIPTION	For quick pinning of attached visual pockets on cartons and other outer packaging made of foil or textile
MATERIAL	Plastic PP
COLOR	Black
PACK QUANTITY	50 pieces
TIP	Compatible attached visual pockets see 02011A5LH15, 02011A4PH15 and 02011A1/3H15

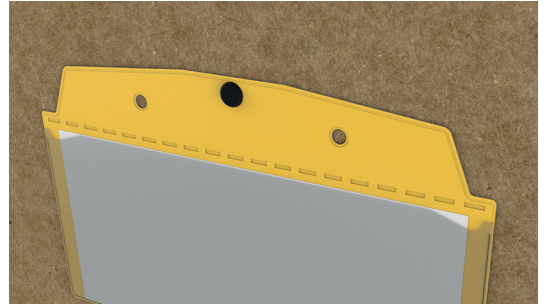
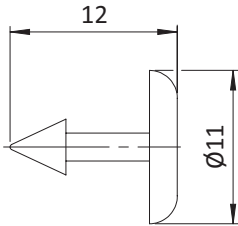

Weight [g]

0.3

Part #

02011E04

PLASTIC TIE FOR VISUAL POCKET

MODEL	For binding to pipes and struts
DESCRIPTION	To bind and unbind attachable visual pockets easily to pipes, cables profiles etc.
MATERIAL	Plastic PE
COLOR	Red
PACK QUANTITY	50 pieces
TIP	Compatible attached visual pockets see 02011A5LH15, 02011A4PH15 and 02011A1/3H15



Weight [g]	Part #
2.5	02011E05

1



FATH

KANBAN LABEL HOLDERS AND ENVELOPES

Identify storage containers quickly and easily with FATH's KANBAN label holders and envelopes



- Self-adhesive
- Magnetic
- For hanging over
- KANBAN clip document holder with extremely strong clamping ability
- KANBAN label holder as per VDA standard
- Scanner readable

HIGHLIGHTS

The **FATH** KANBAN label holders are part of the PVC-free LEAN product family of **FATH** – products which allow you to design your production and logistics processes to be more efficient and leaner while helping to protect the environment at the same time. Instead of the problematic PVC material, plastics with extremely high strengths are used as well as a proportion of recycling material. LEAN products are UV-resistant, extremely durable and free from harmful substances.

With the many variants of the **FATH** KANBAN sleeves and label holders, the Kanban concept can be easily implemented on the shop floor and in intralogistics. The labelling clearly structures the tasks and processes, the pull principle is realised and waste is avoided. The products help to increase productivity and

are suitable for both series production and batch-size-oriented workshop production.



REUSABLE,
MULTI-USE

Magnetic, self-adhesive or for hanging over

Made of transparent, hard-wearing plastic, **FATH**'s KANBAN label holders are available in magnetic, self-adhesive and hang-over versions, all of which are available in different formats. This allows you to label almost any load carrier, container or lattice box with little effort.

The transparent plastic allows scanners to read the inserted documents without difficulty.

FATH

FATH's KANBAN label holders versions and attachment options

Large label holders – self-adhesive or magnetic

The self-adhesive KANBAN label holders are easily affixed to load carriers and remain attached to the object. They are suitable for labeling containers such as Euro boxes and SLCs. Documents can be replaced at any time as required – they can be inserted and removed in an instant thanks to the front foil's slanted edge. The self-adhesive KANBAN label holders are unique due to their reusability and offer flexibility never seen before. The adhesive adheres to glass, plastics, metal and all smooth surfaces.

With stable magnetic stripes attached to the back the magnetic version is suitable for metal containers and many other ferrous surfaces.

KANBAN label holders – for hanging over

Overhanging KANBAN label holders are fabricated in a single piece and are simply placed on the container edge. They can be removed again at any time. Due to its standardized dimensions, this version offers an excellent clamping ability and the containers remain stackable without any limitations. It offers a practical solution for labeling Euro boxes, plastic crates, etc. which need to be cleaned frequently, for example.

Small KANBAN label holders – self-adhesive with clip function and very strong clamping ability

The practical KANBAN clip document holders need to be affixed just once and are suitable for all containers with a non-laminating surface as well as for pallet feet. Insert documents such as material cards or item information cards into the label holders and you instantly have a clear identification of the materials. The KANBAN Clip document holder can be affixed to the inside of the container when necessary in the case of grab containers and semi-open front storage containers. Since re-labeling can be completed in seconds, KANBAN clip document holders are the perfect solution for frequent document changes. FATH's KANBAN clip document holders offer an extra advantage: Thanks to its particularly strong clamping ability, this document holder is also excellent for thick Kanban cards.

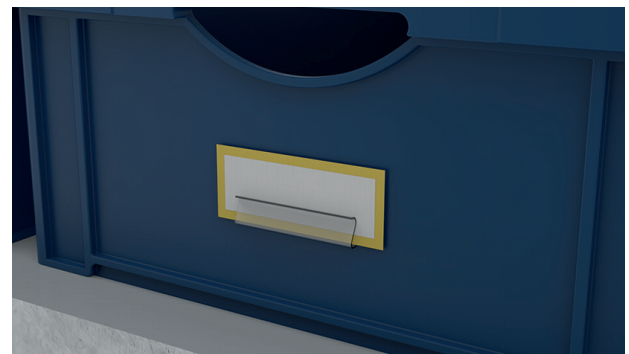
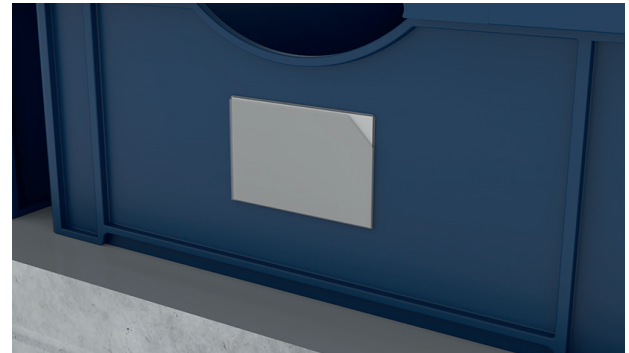

FATH

KANBAN envelopes as per VDA standard – open at the top or side

FATH's KANBAN envelopes are extremely easy to use – simply insert or remove document in an instant. They comply with VDA standard 4902 and can be instantly inserted into the pre-assembled bracket on containers, such as SLCs. Ideally suited for production time cycles.

Documents or cardboard inserts are protected against dirt and moisture in the **FATH's** KANBAN envelope version with an opening at the side. Documents remain legible even in production environments containing humid or oily air where processes such as turning, milling, grinding, or drilling take place

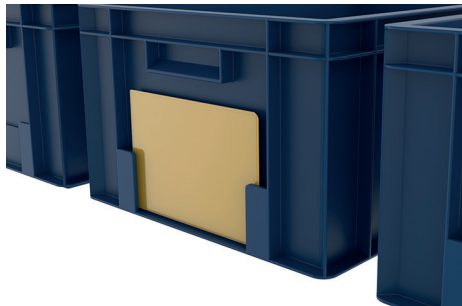

Versions

The **FATH** KANBAN sleeves are available in the following sizes:
200 x 67 mm
200 x 85 mm
200 x 135 mm

and in each case in the following variant:
open at the top
open at the side

The **FATH** KANBAN covers are available in the following colors:

- ① transparent
- ② yellow
- ③ red
- ④ blue
- ⑤ green
- ⑥ grey
- ⑦ black
- ⑧ white

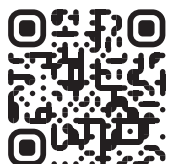
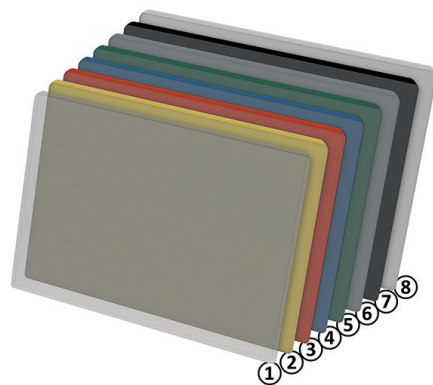

Would you like to learn more about
FATH KANBAN label holders ?

label-holder.fath24.com

TOP OPEN KANBAN ENVELOPE 200 X 67 - 7.9" X 2.6"

MODEL	Top open
DESCRIPTION	Strong and durable envelope for inserting in SLC boxes (small load carrier), Euro containers, Kanban boards etc.; Protects Kanban cards from dirt and abrasion; Tear-resistant and stretchable transparent foil with restoring capacity, scanner-compatible
MATERIAL	Plastic PVC
COLOR	Transparent, yellow, red, blue, green, gray, black, white
PACK QUANTITY	50 pieces

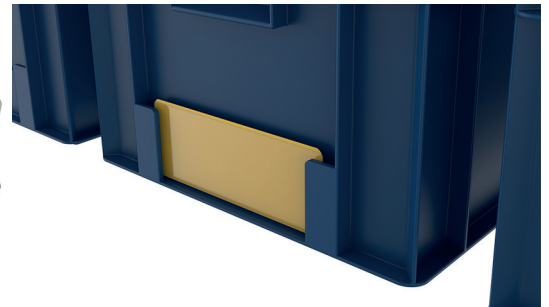
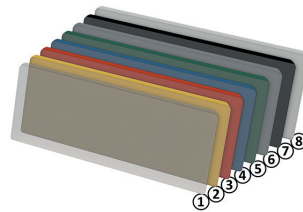
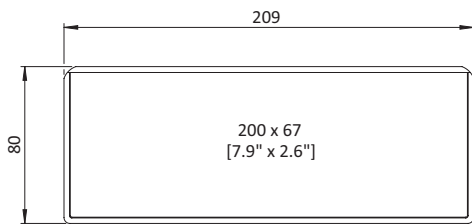

1

Fig.	Color	Weight [g]	Part #
①	Transparent	14.3	02013T6701
②	Yellow ≈ RAL 1018	14.3	02013T6715
③	Red ≈ RAL 3020	14.3	02013T6731
④	Blue ≈ RAL 5017	14.3	02013T6755
⑤	Green ≈ RAL 6016	14.3	02013T6763
⑥	Gray ≈ RAL 7045	14.3	02013T6775
⑦	Black	14.3	02013T6791
⑧	White ≈ RAL 9003	14.3	02013T6793

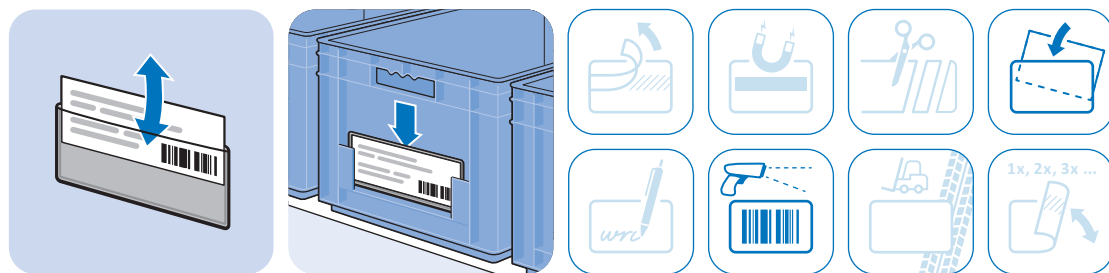

TOP OPEN KANBAN ENVELOPE 200 X 85 - 7.9" X 3.4"

MODEL	Top open
DESCRIPTION	Strong and durable envelope for inserting in SLC boxes (small load carrier), Euro containers, Kanban boards etc.; Protects Kanban cards from dirt and abrasion; Tear-resistant and stretchable transparent foil with restoring capacity, scanner-compatible
MATERIAL	Plastic PVC
COLOR	Transparent, yellow, red, blue, green, gray, black, white
PACK QUANTITY	50 pieces

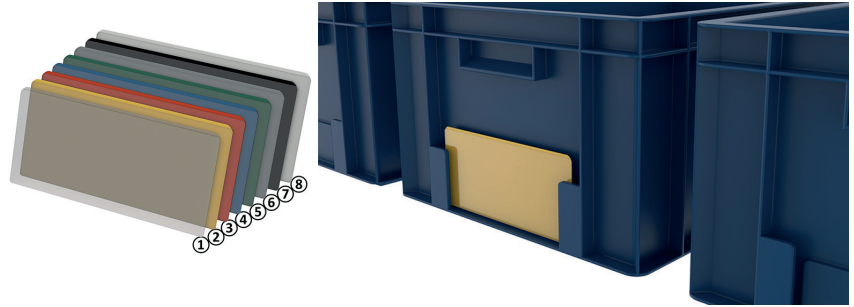
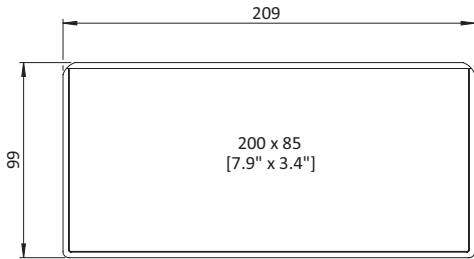
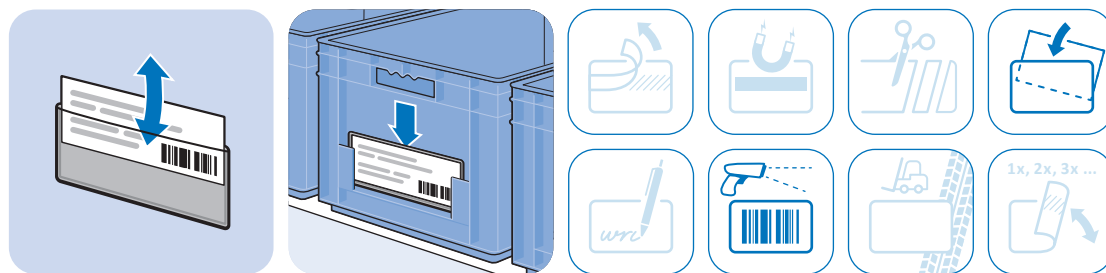
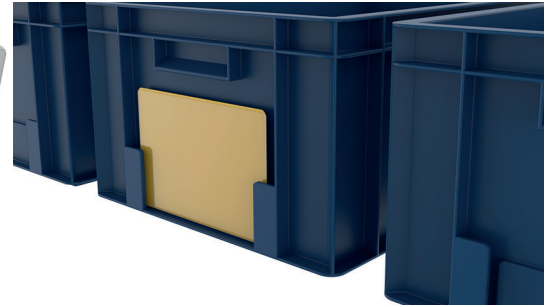
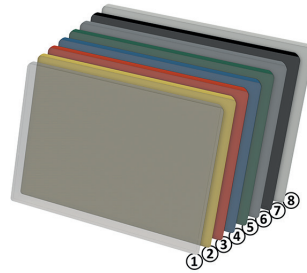
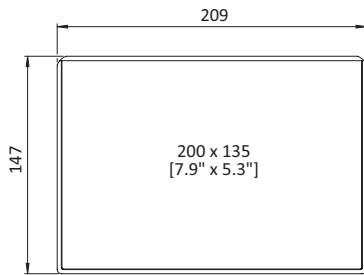

Fig.	Color	Weight [g]	Part #
①	Transparent	15.1	02013T8501
②	Yellow ≈ RAL 1018	15.1	02013T8515
③	Red ≈ RAL 3020	15.1	02013T8531
④	Blue ≈ RAL 5017	15.1	02013T8555
⑤	Green ≈ RAL 6016	15.1	02013T8563
⑥	Gray ≈ RAL 7045	15.1	02013T8575
⑦	Black	15.1	02013T8591
⑧	White ≈ RAL 9003	15.1	02013T8593



TOP OPEN KANBAN ENVELOPE 200 X 135 - 7.9" X 5.3"

MODEL	Top open
DESCRIPTION	Strong and durable envelope for inserting in SLC boxes (small load carrier), Euro containers, Kanban boards etc.; Protects Kanban cards from dirt and abrasion; Tear-resistant and stretchable transparent foil with restoring capacity, scanner-compatible
MATERIAL	Plastic PVC
COLOR	Transparent, yellow, red, blue, green, gray, black, white
PACK QUANTITY	50 pieces



1

Fig.	Color	Weight [g]	Part #
①	Transparent	22.6	02013T13501
②	Yellow ≈ RAL 1018	22.6	02013T13515
③	Red ≈ RAL 3020	22.6	02013T13531
④	Blue ≈ RAL 5017	22.6	02013T13555
⑤	Green ≈ RAL 6016	22.6	02013T13563
⑥	Gray ≈ RAL 7045	22.6	02013T13575
⑦	Black	22.6	02013T13591
⑧	White ≈ RAL 9003	22.6	02013T13593

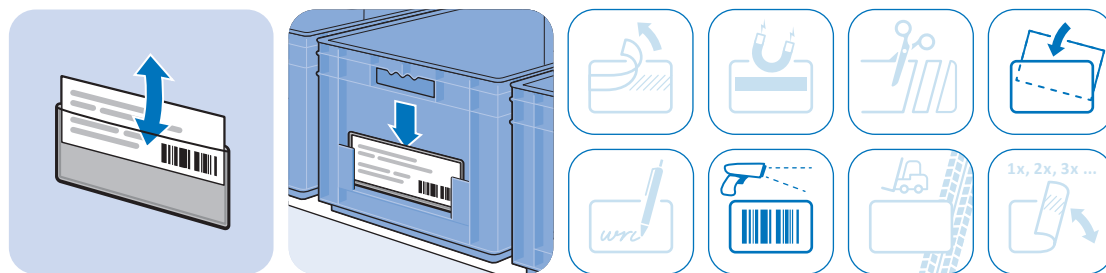

SIDE OPEN KANBAN ENVELOPE 200 X 67 - 7.9" X 2.6"

MODEL	Side open
DESCRIPTION	Strong and durable envelope for inserting in SLC boxes (small load carrier), Euro containers, Kanban boards etc.; Protects Kanban cards from dirt and abrasion; Tear-resistant and stretchable transparent foil with restoring capacity, scanner-compatible
MATERIAL	Plastic PVC
COLOR	Transparent, yellow, red, blue, green, gray, black, white
PACK QUANTITY	50 pieces

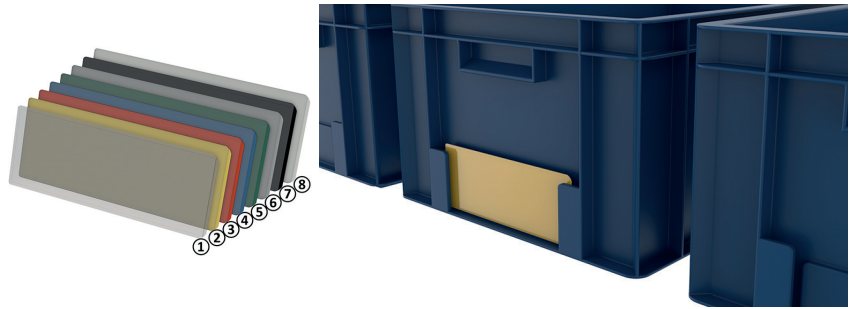
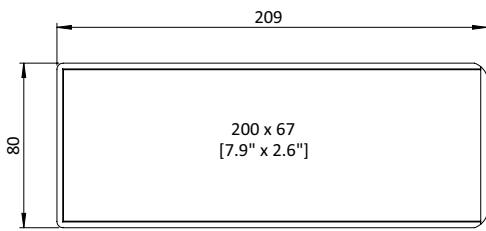
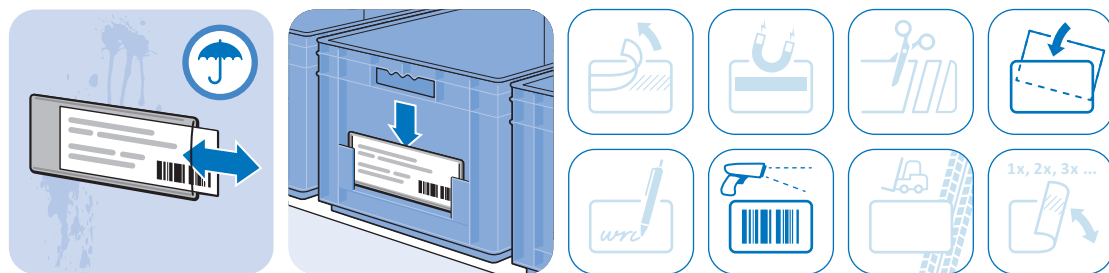

Fig.	Color	Weight [g]	Part #
①	Transparent	14.5	02013S6701
②	Yellow ≈ RAL 1018	14.5	02013S6715
③	Red ≈ RAL 3020	14.5	02013S6731
④	Blue ≈ RAL 5017	14.5	02013S6755
⑤	Green ≈ RAL 6016	14.5	02013S6763
⑥	Gray ≈ RAL 7045	14.5	02013S6775
⑦	Black	14.5	02013S6791
⑧	White ≈ RAL 9003	14.5	02013S6793



SIDE OPEN KANBAN ENVELOPE 200 X 85 - 7.9" X 3.4"

MODEL	Side open
DESCRIPTION	Strong and durable envelope for inserting in SLC boxes (small load carrier), Euro containers, Kanban boards etc.; Protects Kanban cards from dirt and abrasion; Tear-resistant and stretchable transparent foil with restoring capacity, scanner-compatible
MATERIAL	Plastic PVC
COLOR	Transparent, yellow, red, blue, green, gray, black, white
PACK QUANTITY	50 pieces

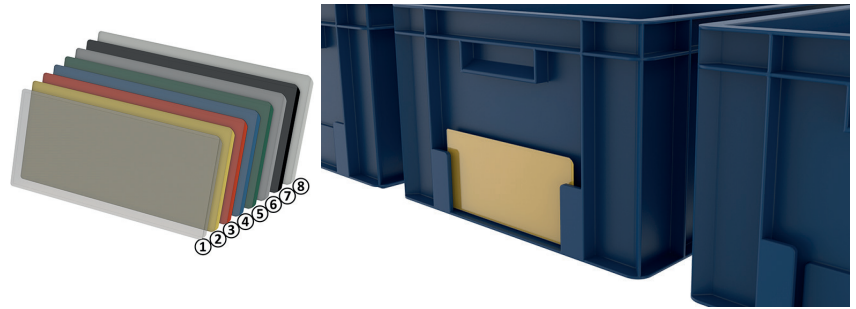
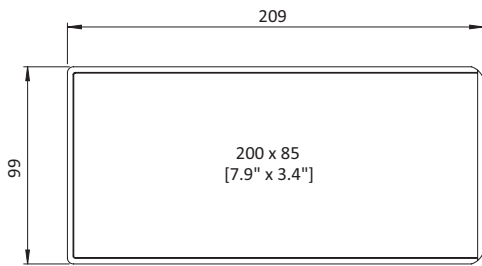
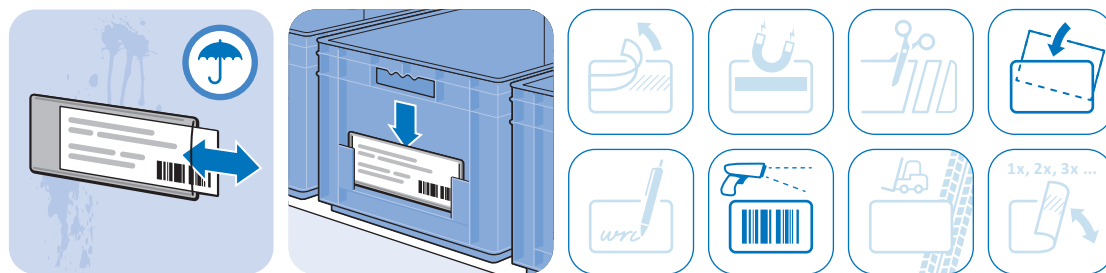

Fig.	Color	Weight [g]	Part #
①	Transparent	15.3	02013S8501
②	Yellow ≈ RAL 1018	15.3	02013S8515
③	Red ≈ RAL 3020	15.3	02013S8531
④	Blue ≈ RAL 5017	15.3	02013S8555
⑤	Green ≈ RAL 6016	15.3	02013S8563
⑥	Gray ≈ RAL 7045	15.3	02013S8575
⑦	Black	15.3	02013S8591
⑧	White ≈ RAL 9003	15.3	02013S8593



1

SIDE OPEN KANBAN ENVELOPE 200 X 135 - 7.9" X 5.3"

MODEL	Side open
DESCRIPTION	Strong and durable envelope for inserting in SLC boxes (small load carrier), Euro containers, Kanban boards etc.; Protects Kanban cards from dirt and abrasion; Tear-resistant and stretchable transparent foil with restoring capacity, scanner-compatible
MATERIAL	Plastic PVC
COLOR	Transparent, yellow, red, blue, green, gray, black, white
PACK QUANTITY	50 pieces

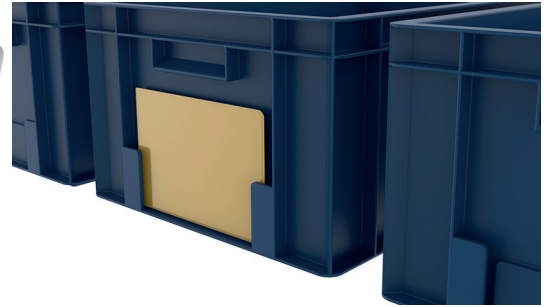
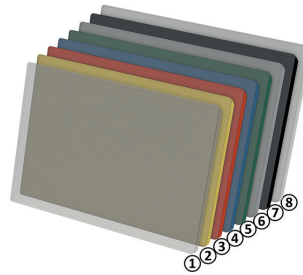
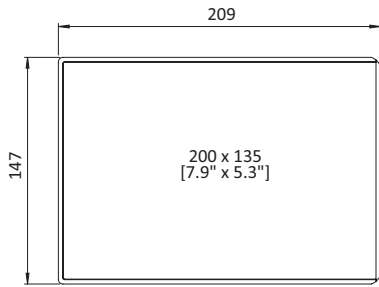
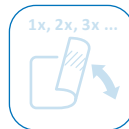
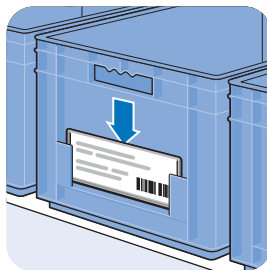
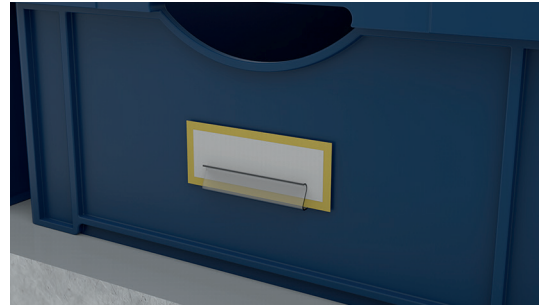
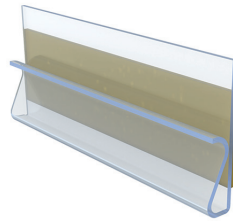
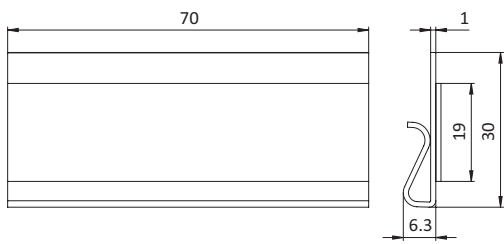

Fig.	Color	Weight [g]	Part #
①	Transparent	22.7	02013S13501
②	Yellow ≈ RAL 1018	22.7	02013S13515
③	Red ≈ RAL 3020	22.7	02013S13531
④	Blue ≈ RAL 5017	22.7	02013S13555
⑤	Green ≈ RAL 6016	22.7	02013S13563
⑥	Gray ≈ RAL 7045	22.7	02013S13575
⑦	Black	22.7	02013S13591
⑧	White ≈ RAL 9003	22.7	02013S13593



KANBAN CLIP DOCUMENT HOLDER 70 X 30 - 2.8" X 1.2"

MODEL	Self-adhesive
DESCRIPTION	Universal clip to hold Kanban cards, label envelopes or documents, For adhesive bonding on various surfaces from plastic containers to wooden pallet feet, Usable for all common formats
MATERIAL	Clip: Plastic PVC Adhesive strip: PE foam
COLOR	Transparent
PACK QUANTITY	100 pieces



1

Weight [g]	Part #
5.0	02012ASA

OVERHANGING KANBAN LABEL HOLDER

MODEL	PVC free, for overhanging on containers
DESCRIPTION	To hold Kanban cards or documents; For overhanging on small load carriers and other boxes, containers stay still stackable; Available in all common formats
MATERIAL	Label holder: Plastic, PVC-free
COLOR	Transparent
PACK QUANTITY	10 pieces

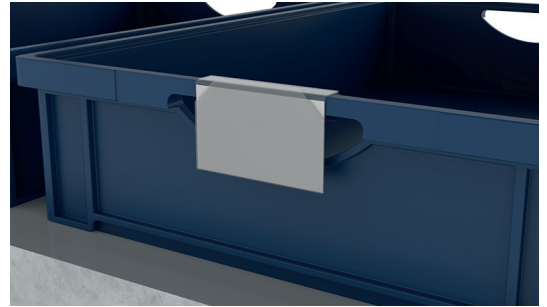
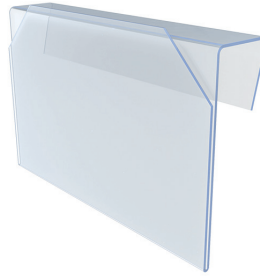
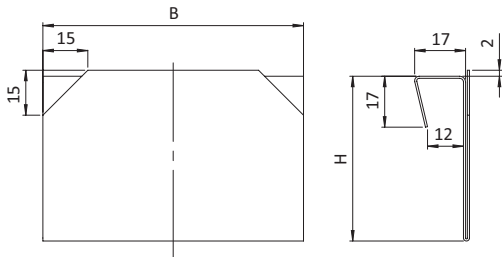

Version	B [mm]	H [mm]	Weight [g]	Part #
EC	87	55	12.2	02012ECH
A7	110	78	20.5	02012A7H
A6	155	108	38.3	02012A6H
A5	215	153	72.4	02012A5H
1/4 DIN	215	78	40.3	02012A1/4H

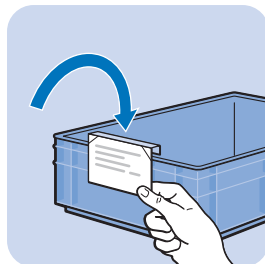
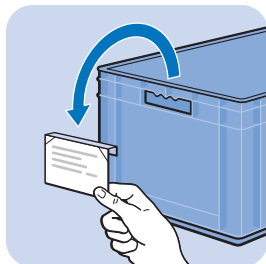
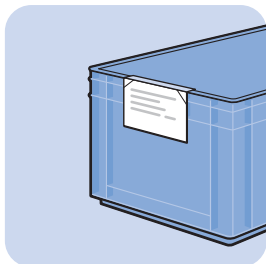

SELF-ADHESIVE KANBAN LABEL HOLDER

MODEL	PVC free, self-adhesive (multi-use)
DESCRIPTION	To hold Kanban cards or documents; For flexible adhesion even on uneven surfaces, removable without leaving any residue, reusable on supporting surfaces thanks to multi-use properties; Available in all common formats
MATERIAL	Label holder: Plastic, PVC-free Adhesive strip: PE foam, reusable
COLOR	Transparent
PACK QUANTITY	10 pieces

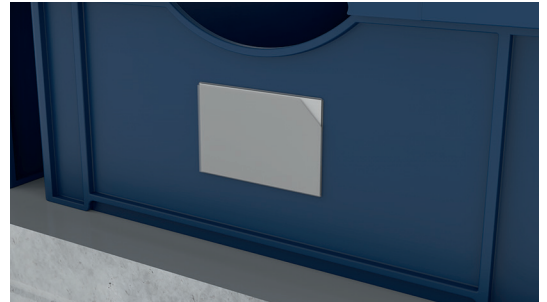
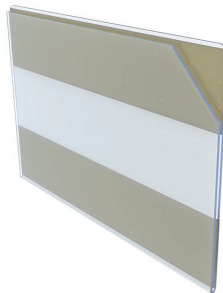
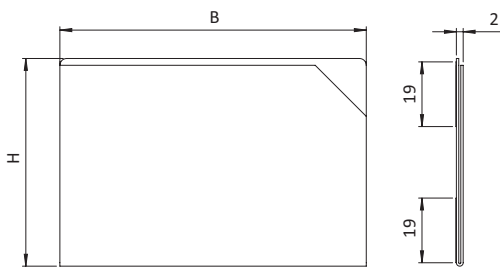

Version	B [mm]	H [mm]	Weight [g]	Part #
EC	90	61	10.6	02012ECA
A7	110	87	17.8	02012A7A
A6	158	117	35.1	02012A6A
A5	220	163	69.0	02012A5A
1/4 DIN	220	92	37.9	02012A1/4A

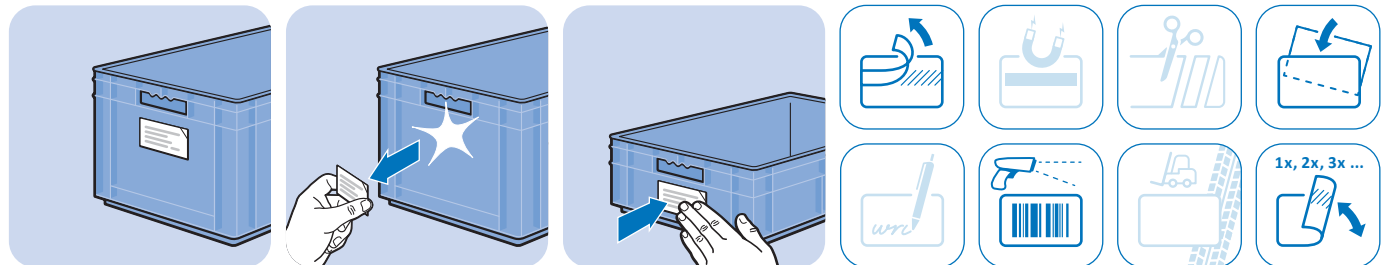

1

MAGNETIC KANBAN LABEL HOLDER

MODEL	PVC free, magnetic
DESCRIPTION	To hold Kanban cards or documents; For magnetic mounting on metallic surfaces; Available in all common formats
MATERIAL	Label holder: Plastic, PVC-free Magnetic strip
COLOR	Transparent
PACK QUANTITY	10 pieces

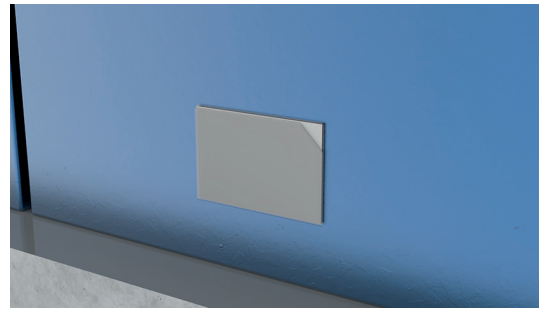
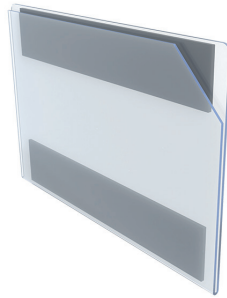
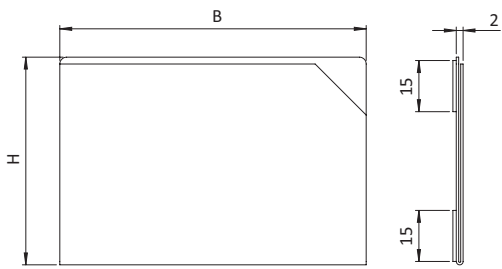

Version	B [mm]	H [mm]	Weight [g]	Part #
EC	90	61	30.0	02012ECM
A7	110	87	40.0	02012A7M
A6	158	117	67.0	02012A6M
A5	220	163	120.0	02012A5M
1/4 DIN	220	92	88.0	02012A1/4M

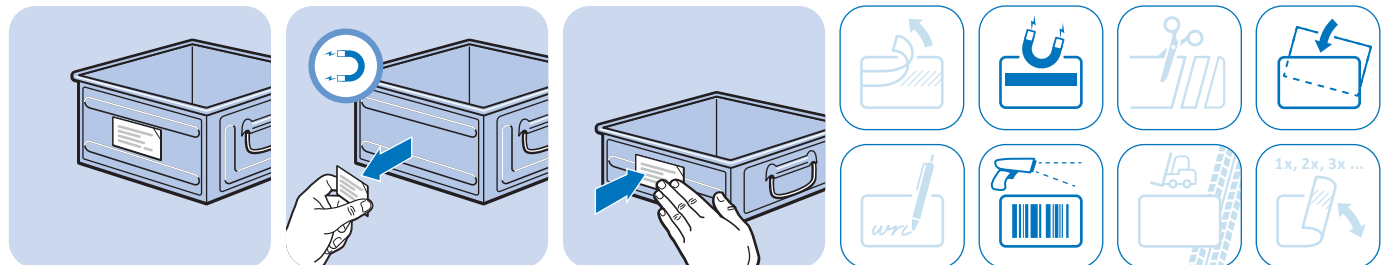

VISUAL MANAGEMENT

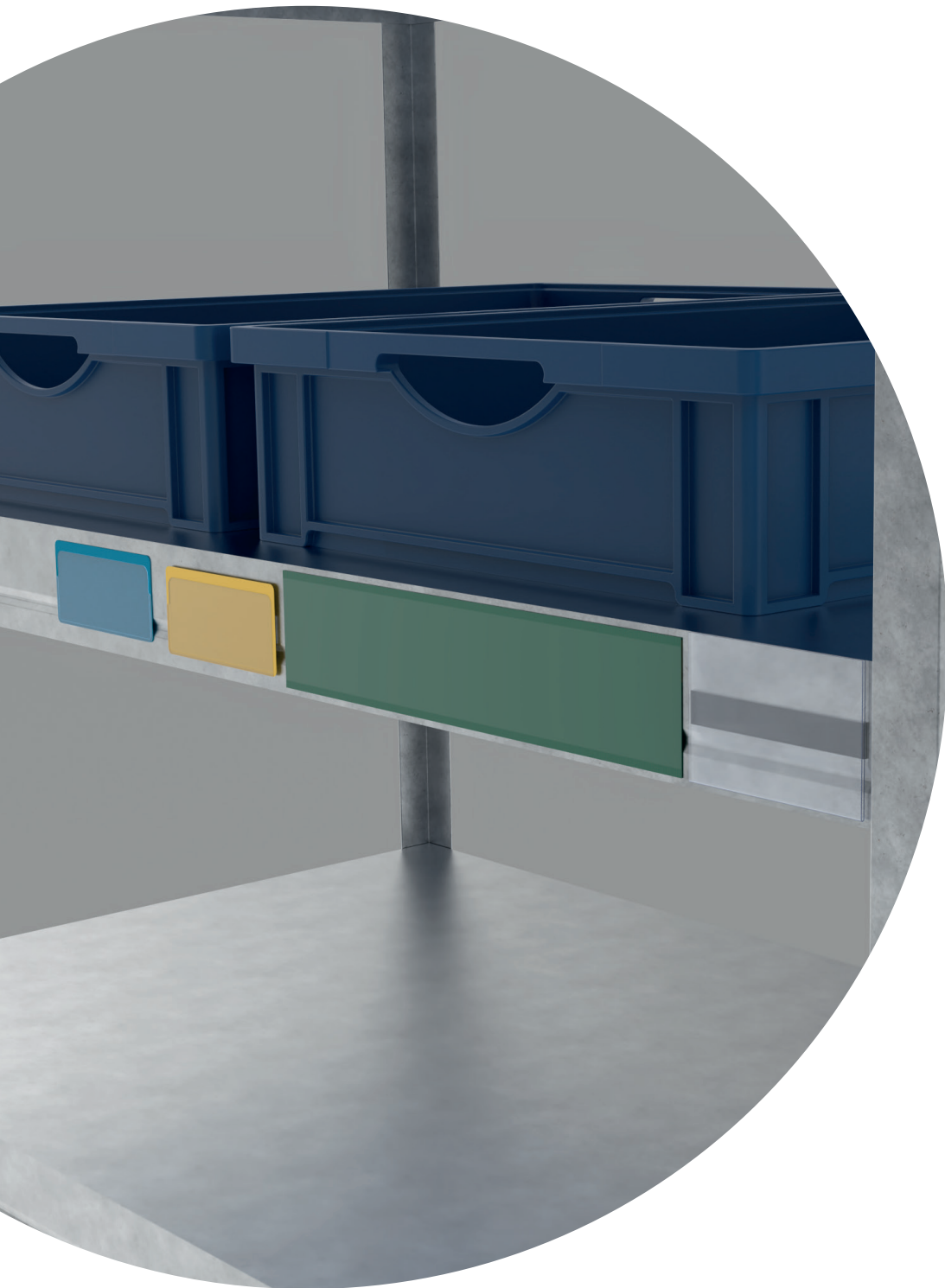

Shelf Labeling

2

Shelf Labeling



Self-adhesive Label Holder 20 - 0.8"

48

Self-adhesive Label Holder 27 - 1.06"

49

Self-adhesive Label Holder 38 - 1.5"

50

Self-adhesive Label Holder 47 - 1.85"

51

Self-adhesive Label Holder 67 - 2.64"

52

Magnetic Label Holder 20 - 0.8"

53

Magnetic Label Holder 27 - 1.06"

54

Magnetic Label Holder 38 - 1.5"

55

Magnetic Label Holder 47 - 1.85"

56

Magnetic Label Holder 67 - 2.64"

57



2-sides Open Self-adhesive Label Envelope 37 - 1.5" **58**



2-sides Open Self-adhesive Label Envelope 50 - 2" **59**

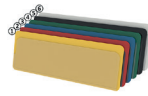

2-sides Open Magnetic Label Envelope 37 - 1.5" **60**



2-sides Open Magnetic Label Envelope 50 - 2" **61**



Top Open Self-adhesive Label Envelope 37 - 1.5" **62**



Top Open Self-adhesive Label Envelope 50 - 2" **63**



Top Open Magnetic Label Envelope 37 - 1.5" **64**



Top Open Magnetic Label Envelope 50 - 2" **65**



Side Open Self-adhesive Label Envelope 60 - 2.4" **66**



Side Open Magnetic Label Envelope 60 - 2.4" **67**

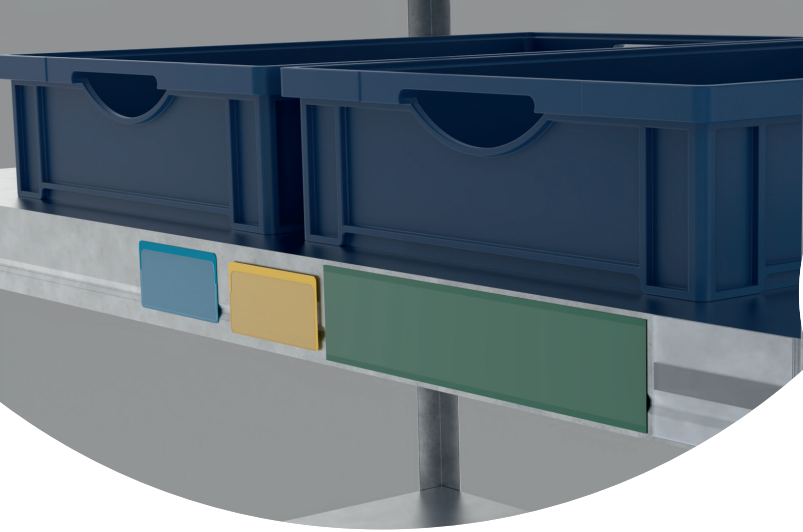

FATH

SHELF LABELINGS

Lean and sustainable:
Label shelves accurately with the reusable FATH Shelf Labelings



- Reusable (multi-use) self-adhesive or magnetic
- PVC-free material
- Many different formats
- With and without color index
- Scanner readable

HIGHLIGHTS

FATH Shelf Labelings can be reused in the self-adhesive version. If the shelves need to be relabeled, the labeling can easily be removed. While conventional adhesives leave stubborn residues that have to be tediously removed, the new self-adhesive products from **FATH** can be removed in one piece and completely residue-free. The adhesive sticks to the shelf labeling and can be immediately reattached elsewhere multiple times.

The shelf label holders are available as reusable (multi-use) self-adhesive or magnetic, either with or without color index and in numerous formats for labeling all standard rack cross beams. Inserted documents are held securely on all types of shelf racks, can be read by a scanner and are easy to change.

FATH Shelf Label Holders are part of the PVC-free LEAN product range for visualization – products with which you can make your production and logistics processes more efficient and leaner and at the same time contribute to greater sustainability. Extremely high-strength plastics are used along with recycled material instead of problematic PVC. The LEAN products are UV-resistant, extremely durable and free from harmful substances.

PVC-FREE & REUSABLE



Unique worldwide: Reusable (multi-use) Self-adhesive shelf labelings

This is new: The **FATH** self-adhesive shelf labelings are reusable again and again, as the innovative adhesive retains its adhesive ability after being removed without leaving any residue behind. The special adhesive smooths unevenness and offers excellent instant adhesion on almost all load-bearing substrates. Simply peel off the backing of the double-sided adhesive tape, press on and it's done!

This is lean and sustainable: The fast and flexible transfer of labels saves working time. The reusability also saves resources and reduces the amount of waste.

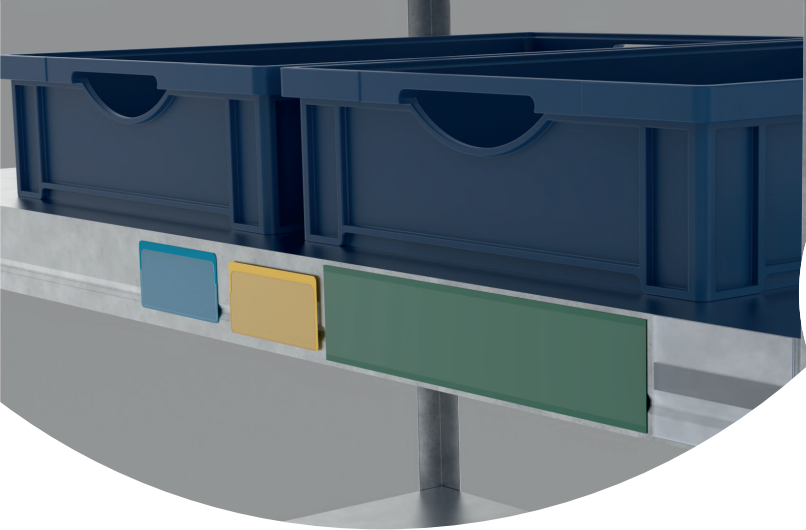

FATH

One of a kind: self-adhesive shelf labelings for multiple use

Something new: The self-adhesive **FATH** Shelf Labelings can be reused multiple times, since the innovative adhesive retains its adhesive function after being removed and leaves no residue. The special adhesive smooths out unevenness and offers excellent instant adhesion on almost all load-bearing surfaces. Simply peel off the backing of the double-sided adhesive tape, press on and you're done!

Magnetic: Insert shelf labelings in one step

The magnetic design of **FATH** Shelf Label Envelopes and Label Holders provide a strong grip on all ferrous surfaces. Once attached, the shelf labeling will remain in place, even withstanding strong vibrations, for example when storing goods with the forklift truck. If relabeling is required, the magnetic shelf labeling is simply removed and repositioned with one movement. The magnet is firmly bonded to the holder and guarantees stability and durability.

Optional: Cardboard inserts for label printing

Placement of shelf labeling could not be easier with **FATH**: Sheets of cardboard in DIN A4 format are available for all sizes – with microperforation in every label size. The sheets are suitable for any standard printer. Fill in templates, separate and insert labels, attach shelf labels – and your shelves are labeled accurately.



2

Versions

The shelf label holders are available in the following versions:

- Reusable (multi-use) Self-adhesive
- Magnetic

Dimensions of the shelf label holders:

- 5 height dimensions between 20 and 67 mm
- 3 width dimensions between 75 and 150 mm
- additional 67 x 200 mm

Colors of the shelf label holders:

- ① yellow
- ② red
- ③ blue
- ④ green
- ⑤ black
- ⑥ white



Would you like to learn more about the **FATH** Shelf Labelings?

shelf-labeling.fath24.com

SELF-ADHESIVE LABEL HOLDER 20 - 0.8"

MODEL	PVC free, self-adhesive (multi-use)
DESCRIPTION	To hold labels; For adhesion on shelves, removable without leaving any residue, reusable on supporting surfaces thanks to multi-use properties; Side and top open, scanner-compatible
MATERIAL	Label holder: Plastic, PVC free Adhesive strip: PE foam, reusable
COLOR	Transparent
PACK QUANTITY	50 pieces

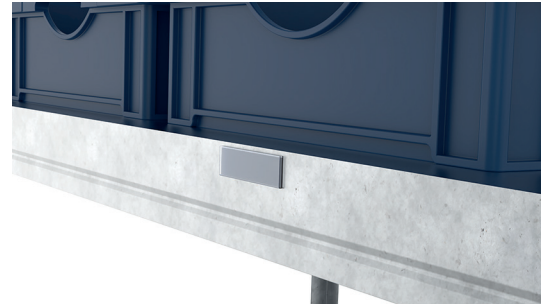
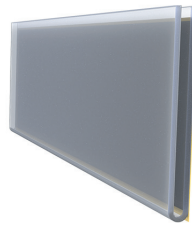
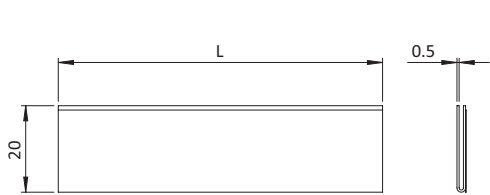

	L [mm]	Weight [g]	Part #
	75.0	2.3	02021H20075A01
	100.0	3.0	02021H20100A01
	150.0	4.6	02021H20150A01

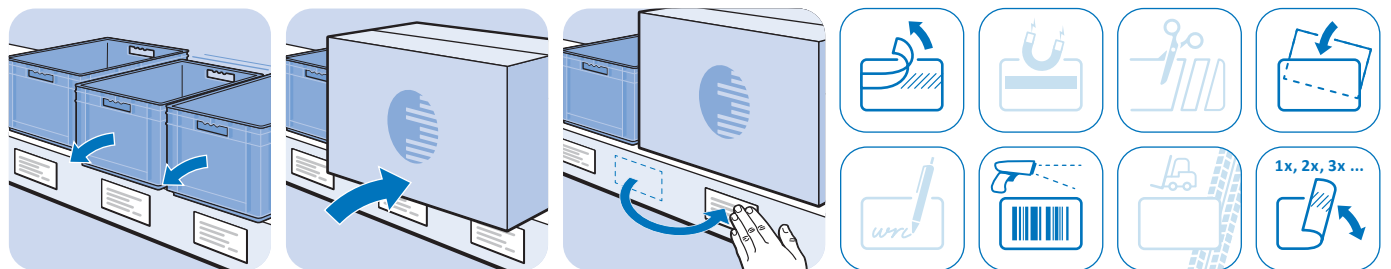

SELF-ADHESIVE LABEL HOLDER 27 - 1.06"

MODEL	PVC free, self-adhesive (multi-use)
DESCRIPTION	To hold labels; For adhesion on shelves, removable without leaving any residue, reusable on supporting surfaces thanks to multi-use properties; Side and top open, scanner-compatible
MATERIAL	Label holder: Plastic, PVC free Adhesive strip: PE foam, reusable
COLOR	Transparent
PACK QUANTITY	50 pieces

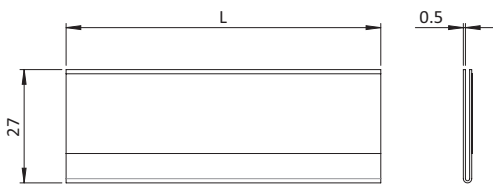

2

L [mm]	Weight [g]	Part #
75.0	3.0	02021H27075A01
100.0	4.0	02021H27100A01
150.0	7.0	02021H27150A01

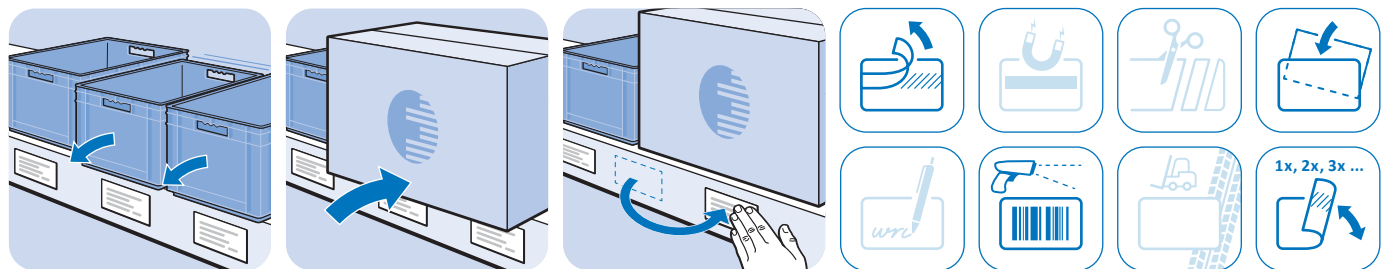

SELF-ADHESIVE LABEL HOLDER 38 - 1.5"

MODEL	PVC free, self-adhesive (multi-use)
DESCRIPTION	To hold labels; For adhesion on shelves, removable without leaving any residue, reusable on supporting surfaces thanks to multi-use properties; Side and top open, scanner-compatible
MATERIAL	Label holder: Plastic, PVC free Adhesive strip: PE foam, reusable
COLOR	Transparent
PACK QUANTITY	50 pieces



L [mm]	Weight [g]	Part #
75.0	5.0	02021H38075A01
100.0	6.0	02021H38100A01
150.0	9.0	02021H38150A01

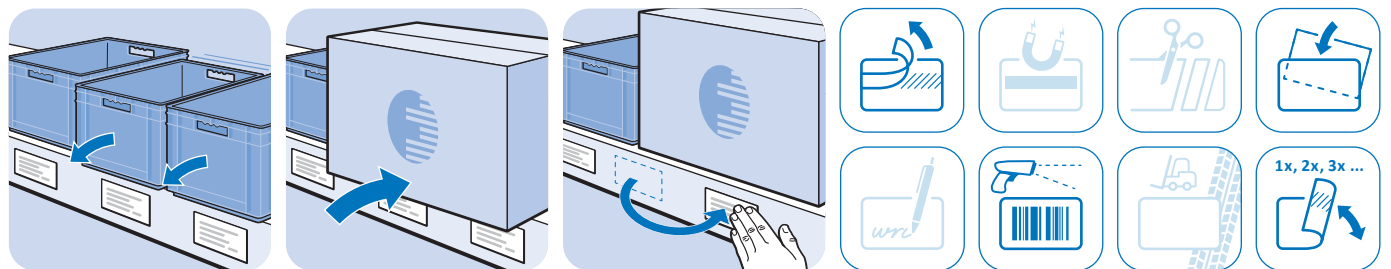

SELF-ADHESIVE LABEL HOLDER 47 - 1.85"

MODEL	PVC free, self-adhesive (multi-use)
DESCRIPTION	To hold labels; For adhesion on shelves, removable without leaving any residue, reusable on supporting surfaces thanks to multi-use properties; Side and top open, scanner-compatible
MATERIAL	Label holder: Plastic, PVC free Adhesive strip: PE foam, reusable
COLOR	Transparent
PACK QUANTITY	50 pieces



L [mm]	Weight [g]	Part #
100.0	7.0	02021H47100A01
150.0	11.0	02021H47150A01

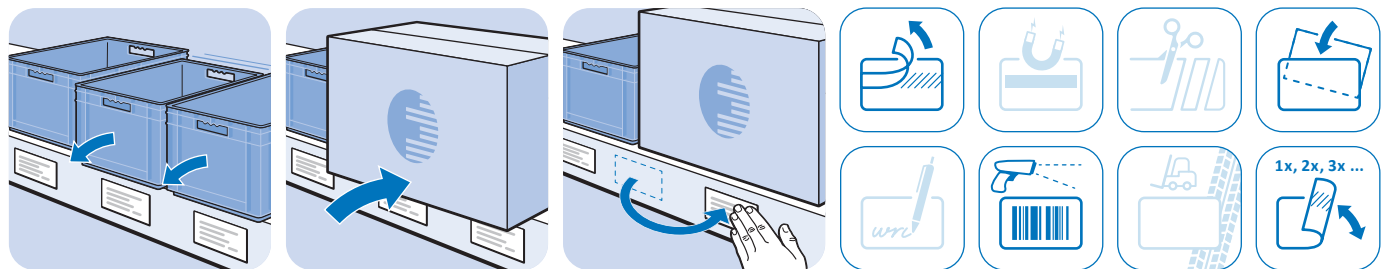

2

SELF-ADHESIVE LABEL HOLDER 67 - 2.64"

MODEL	PVC free, self-adhesive (multi-use)
DESCRIPTION	To hold labels; For adhesion on shelves, removable without leaving any residue, reusable on supporting surfaces thanks to multi-use properties; Side and top open, scanner-compatible
MATERIAL	Label holder: Plastic, PVC free Adhesive strip: PE foam, reusable
COLOR	Transparent
PACK QUANTITY	50 pieces

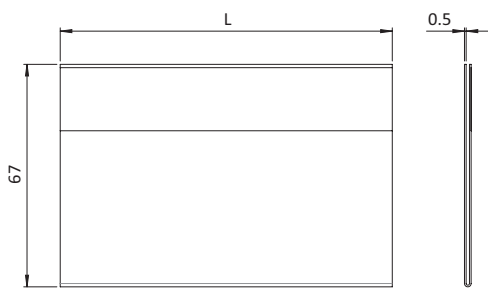

L [mm]	Weight [g]	Part #
100.0	10.0	02021H67100A01
200.0	20.0	02021H67200A01

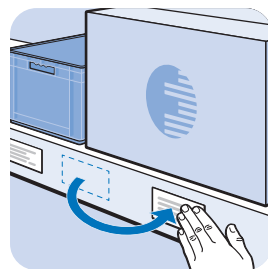
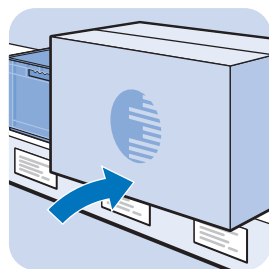
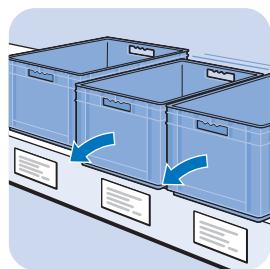

MAGNETIC LABEL HOLDER 20 - 0.8"

MODEL	PVC free, magnetic
DESCRIPTION	To hold labels; For magnetic mounting on metallic surfaces, e.g. shelves; Side and top open, scanner-compatible
MATERIAL	Label holder: Plastic, PVC free Magnetic strip
COLOR	Transparent
PACK QUANTITY	50 pieces

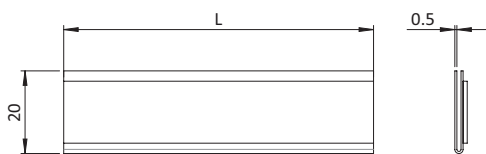

2

L [mm]	Weight [g]	Part #
75.0	11.0	02021H20075M01
100.0	15.0	02021H20100M01
150.0	22.0	02021H20150M01

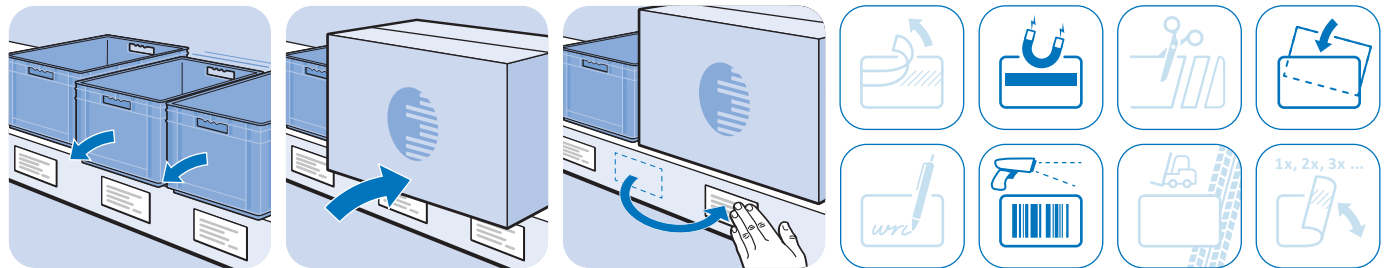

MAGNETIC LABEL HOLDER 27 - 1.06"

MODEL	PVC free, magnetic
DESCRIPTION	To hold labels; For magnetic mounting on metallic surfaces, e.g. shelves; Side and top open, scanner-compatible
MATERIAL	Label holder: Plastic, PVC free Magnetic strip
COLOR	Transparent
PACK QUANTITY	50 pieces

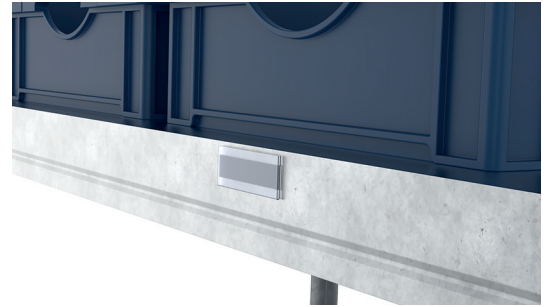
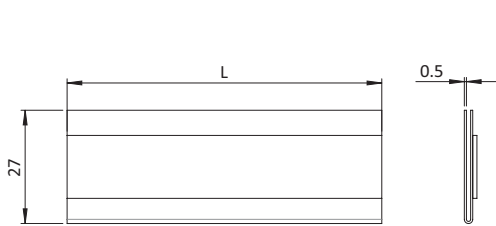

L [mm]	Weight [g]	Part #
75.0	12	02021H27075M01
100.0	16.0	02021H27100M01
150.0	24.0	02021H27150M01

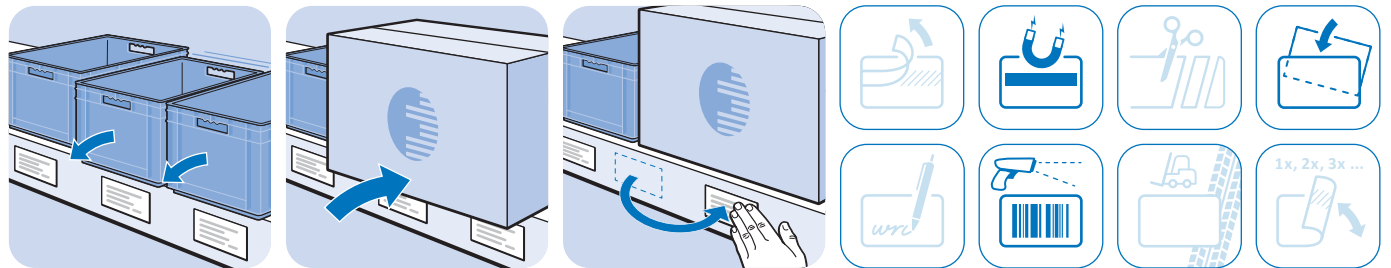

MAGNETIC LABEL HOLDER 38 - 1.5"

MODEL	PVC free, magnetic
DESCRIPTION	To hold labels; For magnetic mounting on metallic surfaces, e.g. shelves; Side and top open, scanner-compatible
MATERIAL	Label holder: Plastic, PVC free Magnetic strip
COLOR	Transparent
PACK QUANTITY	50 pieces

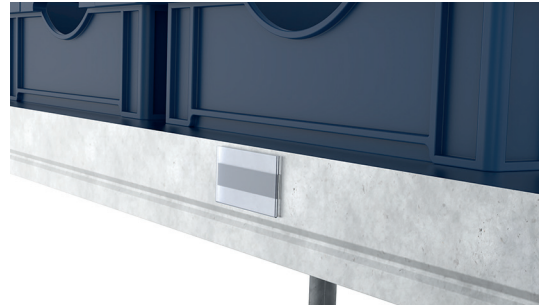
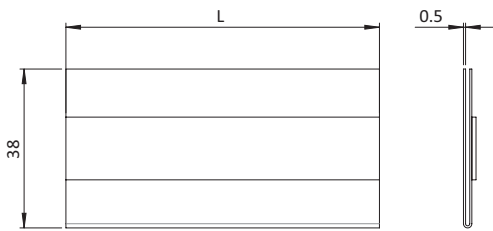

2

L [mm]	Weight [g]	Part #
75.0	13.0	02021H38075M01
100.0	18.0	02021H38100M01
150.0	26.0	02021H38150M01

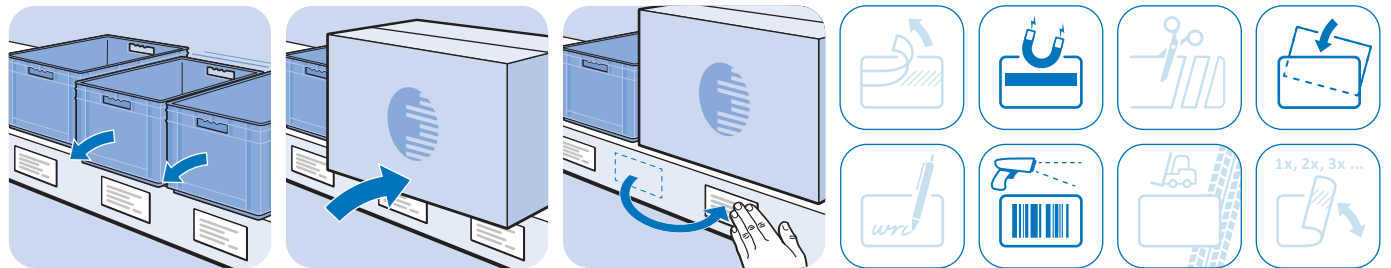

MAGNETIC LABEL HOLDER 47 - 1.85"

MODEL	PVC free, magnetic
DESCRIPTION	To hold labels; For magnetic mounting on metallic surfaces, e.g. shelves; Side and top open, scanner-compatible
MATERIAL	Label holder: Plastic, PVC free Magnetic strip
COLOR	Transparent
PACK QUANTITY	50 pieces



L [mm]	Weight [g]	Part #
100.0	19.0	02021H47100M01
150.0	28.0	02021H47150M01

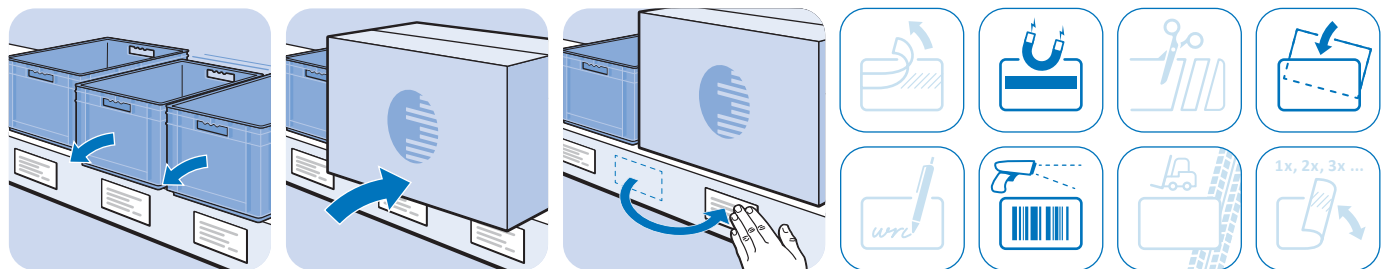

MAGNETIC LABEL HOLDER 67 - 2.64"

MODEL	PVC free, magnetic
DESCRIPTION	To hold labels; For magnetic mounting on metallic surfaces, e.g. shelves; Side and top open, scanner-compatible
MATERIAL	Label holder: Plastic, PVC free Magnetic strip
COLOR	Transparent
PACK QUANTITY	50 pieces

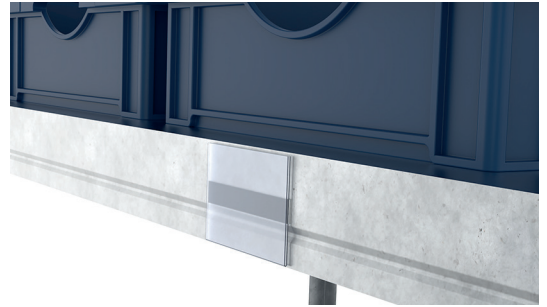
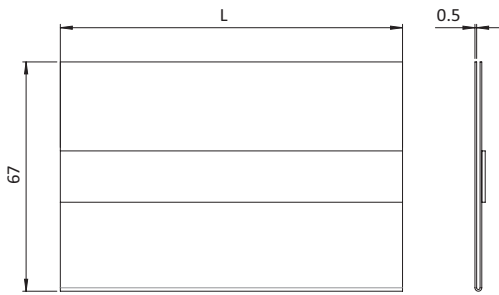

2

L [mm]	Weight [g]	Part #
100.0	22.0	02021H67100M01
200.0	43.0	02021H67200M01

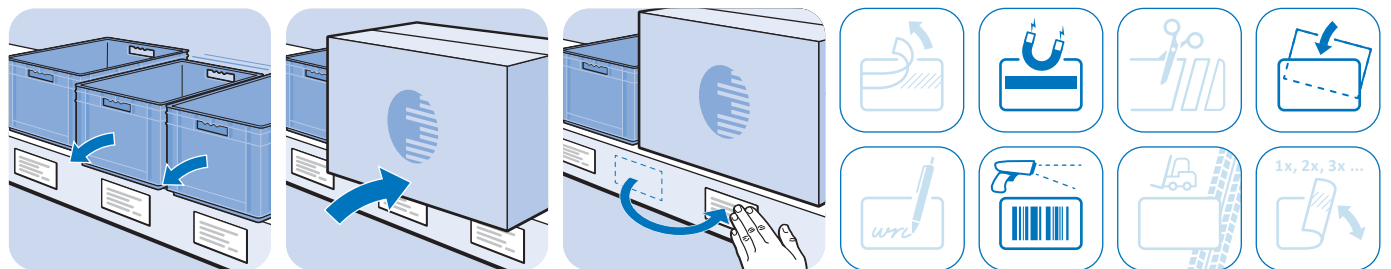

2-SIDES OPEN SELF-ADHESIVE LABEL ENVELOPE 37 - 1.5"

MODEL	Self-adhesive (multi-use)
DESCRIPTION	To hold labels; For flexible adhesion on shelves even on uneven surfaces, removable without leaving any residue, reusable on supporting surfaces thanks to multi-use properties; Top and right side open for quick label change, tear-resistant and stretchable transparent foil with restoring capacity, scanner-compatible
MATERIAL	Label envelope: Plastic, PVC Adhesive strip: PE foam, reusable
COLOR	Yellow, red, blue, green, black, white
PACK QUANTITY	50 pieces

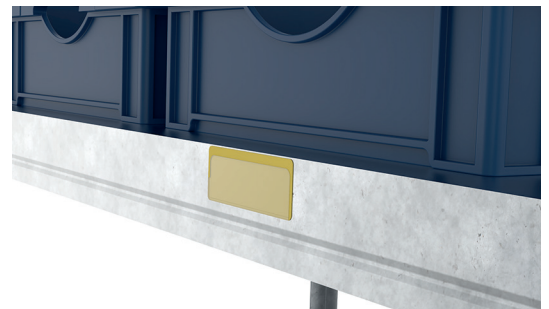
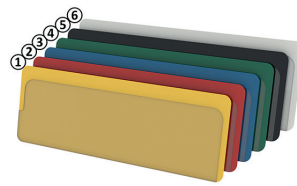
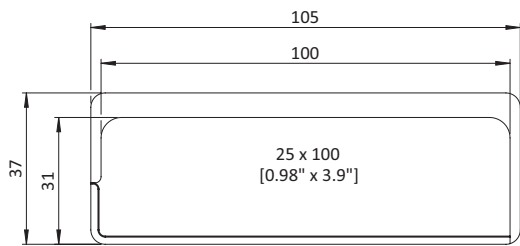
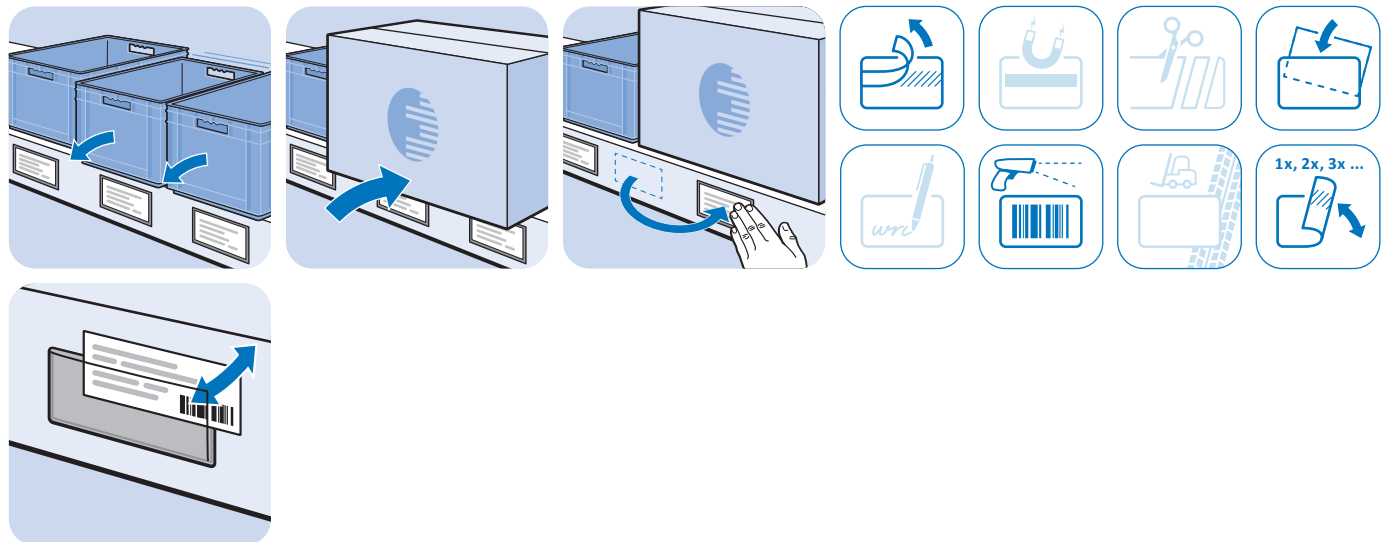
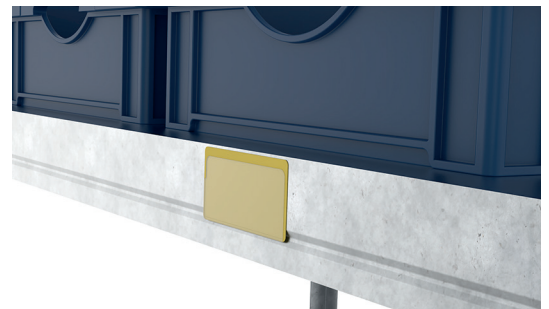
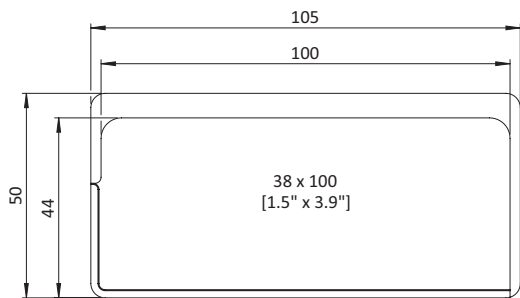

Fig.	Color	Weight [g]	Part #
①	Yellow ≈ RAL 1018	2.0	02021E37105LA15
②	Red ≈ RAL 3020	2.0	02021E37105LA31
③	Blue ≈ RAL 5017	2.0	02021E37105LA55
④	Green ≈ RAL 6016	2.0	02021E37105LA63
⑤	Black	2.0	02021E37105LA91
⑥	White ≈ RAL 9003	2.0	02021E37105LA93



2-SIDES OPEN SELF-ADHESIVE LABEL ENVELOPE 50 - 2"

MODEL	Self-adhesive (multi-use)
DESCRIPTION	To hold labels; For flexible adhesion on shelves even on uneven surfaces, removable without leaving any residue, reusable on supporting surfaces thanks to multi-use properties; Top and right side open for quick label change, tear-resistant and stretchable transparent foil with restoring capacity, scanner-compatible
MATERIAL	Label envelope: Plastic, PVC Adhesive strip: PE foam, reusable
COLOR	Yellow, red, blue, green, black, white
PACK QUANTITY	50 pieces



2

Fig.	Color	Weight [g]	Part #
①	Yellow ≈ RAL 1018	2.6	02021E50105LA15
②	Red ≈ RAL 3020	2.6	02021E50105LA31
③	Blue ≈ RAL 5017	2.6	02021E50105LA55
④	Green ≈ RAL 6016	2.6	02021E50105LA63
⑤	Black	2.6	02021E50105LA91
⑥	White ≈ RAL 9003	2.6	02021E50105LA93

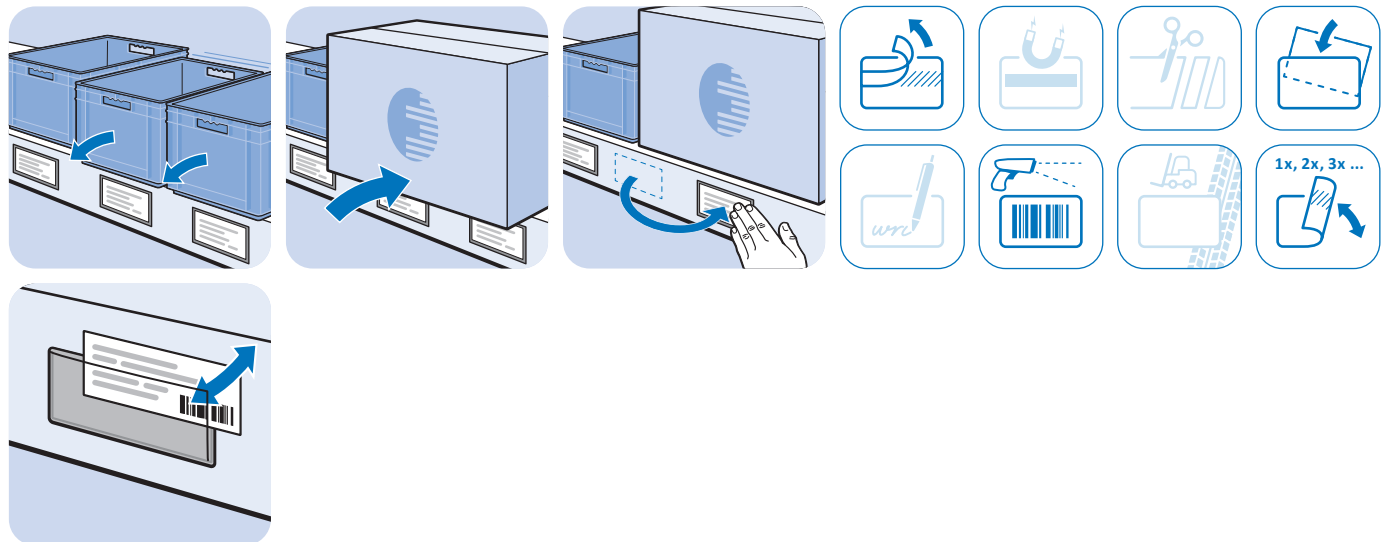

2-SIDES OPEN MAGNETIC LABEL ENVELOPE 37 - 1.5"

MODEL	Magnetic
DESCRIPTION	To hold labels; For magnetic mounting on metallic surfaces, e.g. shelves; Top and right side open for quick label change, tear-resistant and stretchable transparent foil with restoring capacity, scanner-compatible
MATERIAL	Label envelope: Plastic, PVC Magnetic strip
COLOR	Yellow, red, blue, green, black, white
PACK QUANTITY	50 pieces

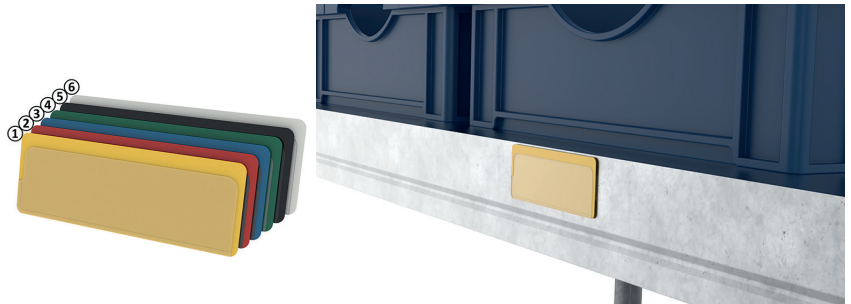
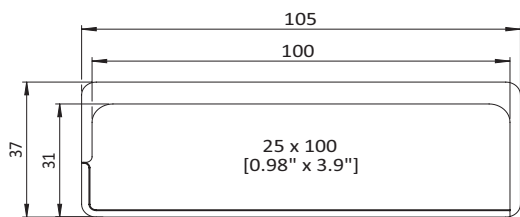
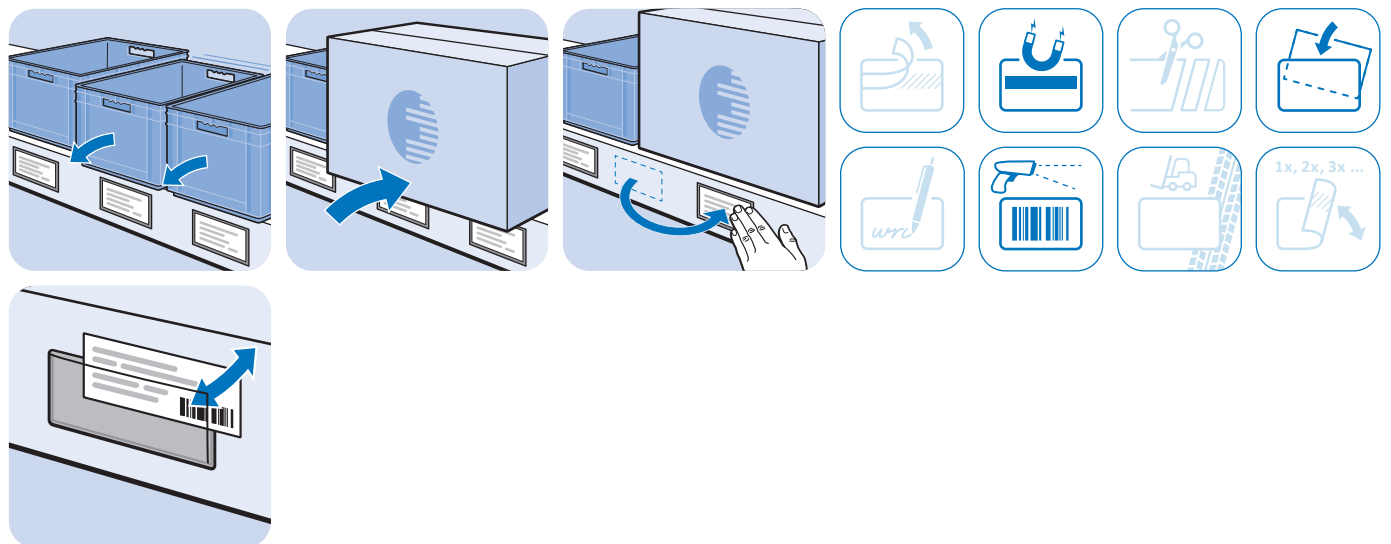

Fig.	Color	Weight [g]	Part #
①	Yellow ≈ RAL 1018	13.6	02021E37105LM15
②	Red ≈ RAL 3020	13.6	02021E37105LM31
③	Blue ≈ RAL 5017	13.6	02021E37105LM55
④	Green ≈ RAL 6016	13.6	02021E37105LM63
⑤	Black	13.6	02021E37105LM91
⑥	White ≈ RAL 9003	13.6	02021E37105LM93



2-SIDES OPEN MAGNETIC LABEL ENVELOPE 50 - 2"

MODEL	Magnetic
DESCRIPTION	To hold labels; For magnetic mounting on metallic surfaces, e.g. shelves; Top and right side open for quick label change, tear-resistant and stretchable transparent foil with restoring capacity, scanner-compatible
MATERIAL	Label envelope: Plastic, PVC Magnetic strip
COLOR	Yellow, red, blue, green, black, white
PACK QUANTITY	50 pieces

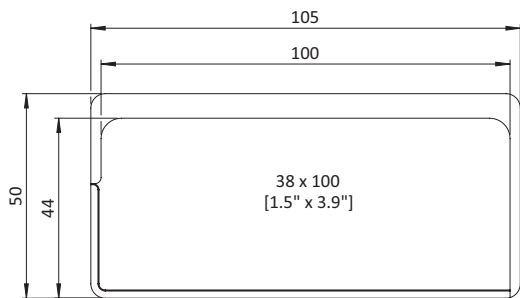
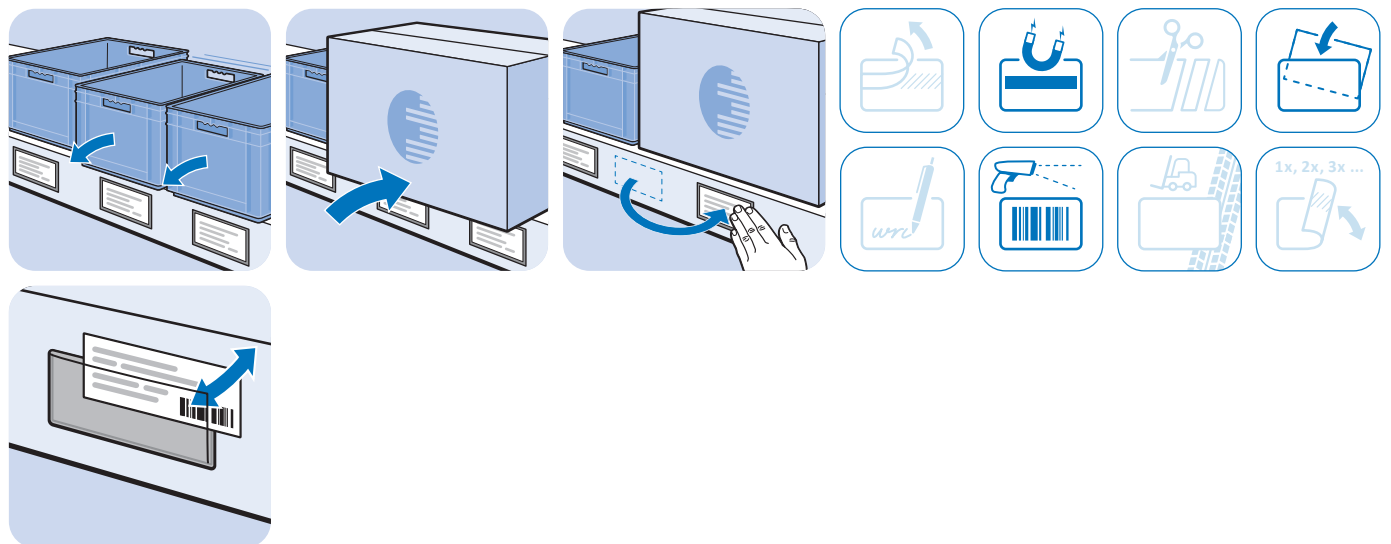

Fig.	Color	Weight [g]	Part #
①	Yellow ≈ RAL 1018	14.2	02021E50105LM15
②	Red ≈ RAL 3020	14.2	02021E50105LM31
③	Blue ≈ RAL 5017	14.2	02021E50105LM55
④	Green ≈ RAL 6016	14.2	02021E50105LM63
⑤	Black	14.2	02021E50105LM91
⑥	White ≈ RAL 9003	14.2	02021E50105LM93



TOP OPEN SELF-ADHESIVE LABEL ENVELOPE 37 - 1.5"

MODEL	Self-adhesive (multi-use)
DESCRIPTION	To hold labels; For flexible adhesion on shelves even on uneven surfaces, removable without leaving any residue, reusable on supporting surfaces thanks to multi-use properties; Top open, tear-resistant and stretchable transparent foil with restoring capacity, scanner-compatible
MATERIAL	Label envelope: Plastic, PVC Adhesive strip: PE foam, reusable
COLOR	Yellow, red, blue, green, black, white
PACK QUANTITY	50 pieces

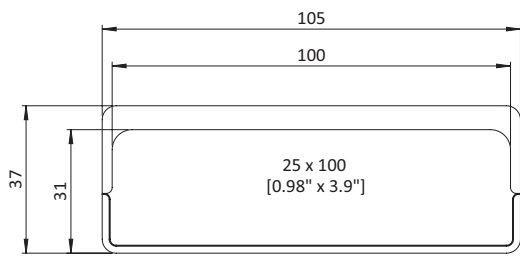
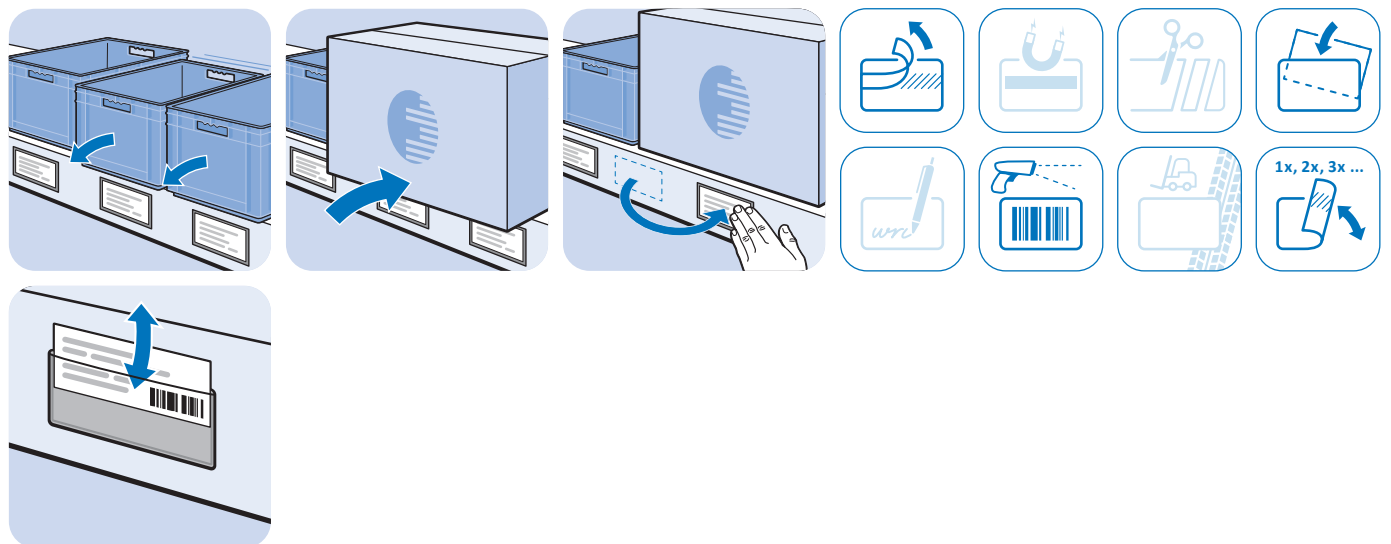
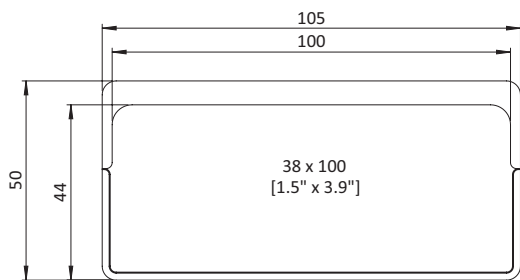

Fig.	Color	Weight [g]	Part #
①	Yellow ≈ RAL 1018	2.0	02021E37105TA15
②	Red ≈ RAL 3020	2.0	02021E37105TA31
③	Blue ≈ RAL 5017	2.0	02021E37105TA55
④	Green ≈ RAL 6016	2.0	02021E37105TA63
⑤	Black	2.0	02021E37105TA91
⑥	White ≈ RAL 9003	2.0	02021E37105TA93



TOP OPEN SELF-ADHESIVE LABEL ENVELOPE 50 - 2"

MODEL	Self-adhesive (multi-use)
DESCRIPTION	To hold labels; For flexible adhesion on shelves even on uneven surfaces, removable without leaving any residue, reusable on supporting surfaces thanks to multi-use properties; Top open, tear-resistant and stretchable transparent foil with restoring capacity, scanner-compatible
MATERIAL	Label envelope: Plastic, PVC Adhesive strip: PE foam, reusable
COLOR	Yellow, red, blue, green, black, white
PACK QUANTITY	50 pieces



2

Fig.	Color	Weight [g]	Part #
①	Yellow ≈ RAL 1018	2.6	02021E50105TA15
②	Red ≈ RAL 3020	2.6	02021E50105TA31
③	Blue ≈ RAL 5017	2.6	02021E50105TA55
④	Green ≈ RAL 6016	2.6	02021E50105TA63
⑤	Black	2.6	02021E50105TA91
⑥	White ≈ RAL 9003	2.6	02021E50105TA93

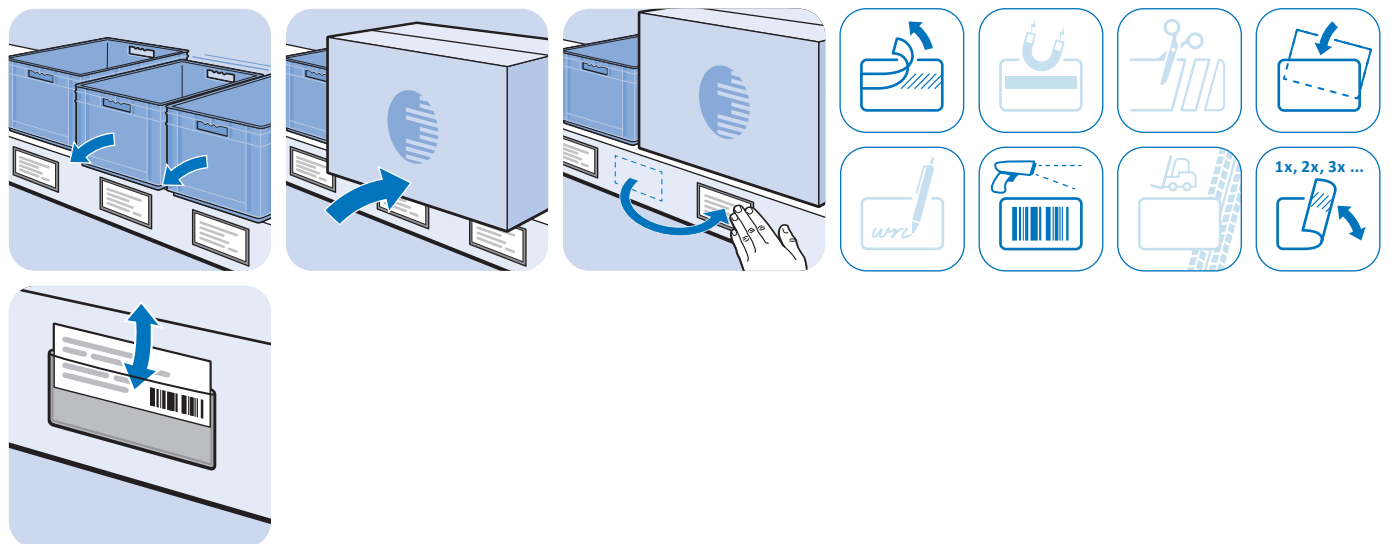

TOP OPEN MAGNETIC LABEL ENVELOPE 37 - 1.5"

MODEL	Magnetic
DESCRIPTION	To hold labels; For magnetic mounting on metallic surfaces, e.g. shelves; Top open, tear-resistant and stretchable transparent foil with restoring capacity, scanner-compatible
MATERIAL	Label envelope: Plastic, PVC Magnetic strip
COLOR	Yellow, red, blue, green, black, white
PACK QUANTITY	50 pieces

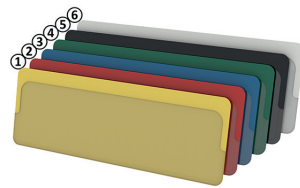
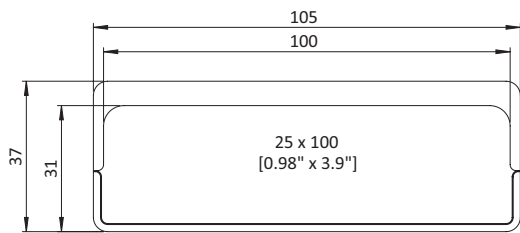
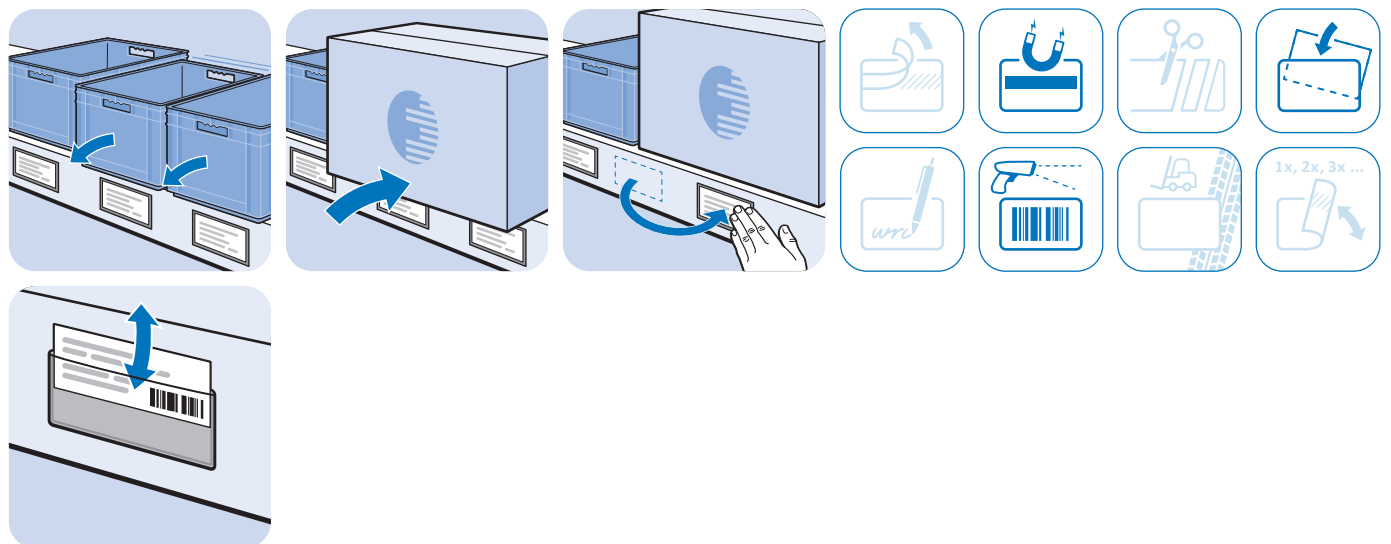
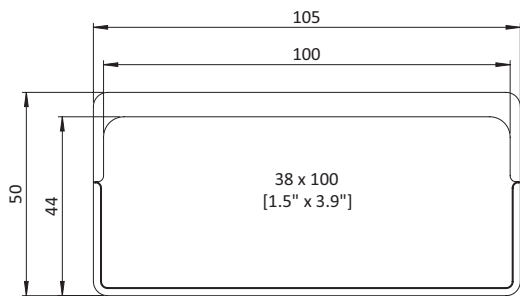

Fig.	Color	Weight [g]	Part #
①	Yellow ≈ RAL 1018	13.6	02021E37105TM15
②	Red ≈ RAL 3020	13.6	02021E37105TM31
③	Blue ≈ RAL 5017	13.6	02021E37105TM55
④	Green ≈ RAL 6016	13.6	02021E37105TM63
⑤	Black	13.6	02021E37105TM91
⑥	White ≈ RAL 9003	13.6	02021E37105TM93



TOP OPEN MAGNETIC LABEL ENVELOPE 50 - 2"

MODEL	Magnetic
DESCRIPTION	To hold labels; For magnetic mounting on metallic surfaces, e.g. shelves; Top open, tear-resistant and stretchable transparent foil with restoring capacity, scanner-compatible
MATERIAL	Label envelope: Plastic, PVC Magnetic strip
COLOR	Yellow, red, blue, green, black, white
PACK QUANTITY	50 pieces



2

Fig.	Color	Weight [g]	Part #
①	Yellow ≈ RAL 1018	14.2	02021E50105TM15
②	Red ≈ RAL 3020	14.2	02021E50105TM31
③	Blue ≈ RAL 5017	14.2	02021E50105TM55
④	Green ≈ RAL 6016	14.2	02021E50105TM63
⑤	Black	14.2	02021E50105TM91
⑥	White ≈ RAL 9003	14.2	02021E50105TM93

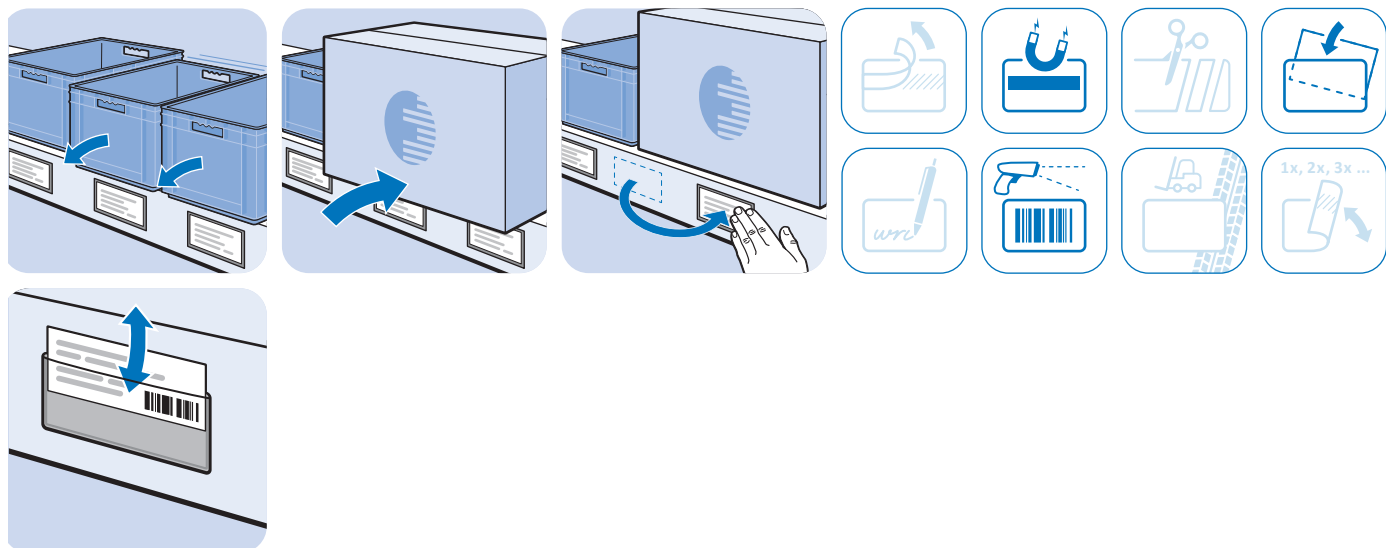

SIDE OPEN SELF-ADHESIVE LABEL ENVELOPE 60 - 2.4"

MODEL	Self-adhesive (multi-use)
DESCRIPTION	To hold labels; For flexible adhesion on shelves even on uneven surfaces, removable without leaving any residue, reusable on supporting surfaces thanks to multi-use properties; Side open only for special protection against wet and dust, tear-resistant and stretchable transparent foil with restoring capacity, scanner-compatible
MATERIAL	Label envelope: Plastic, PVC Adhesive strip: PE foam, reusable
COLOR	Yellow, red, blue, green, white
PACK QUANTITY	50 pieces

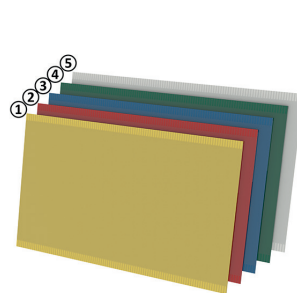
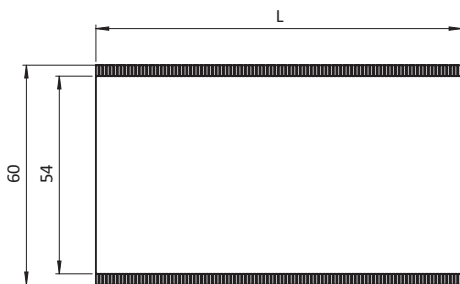
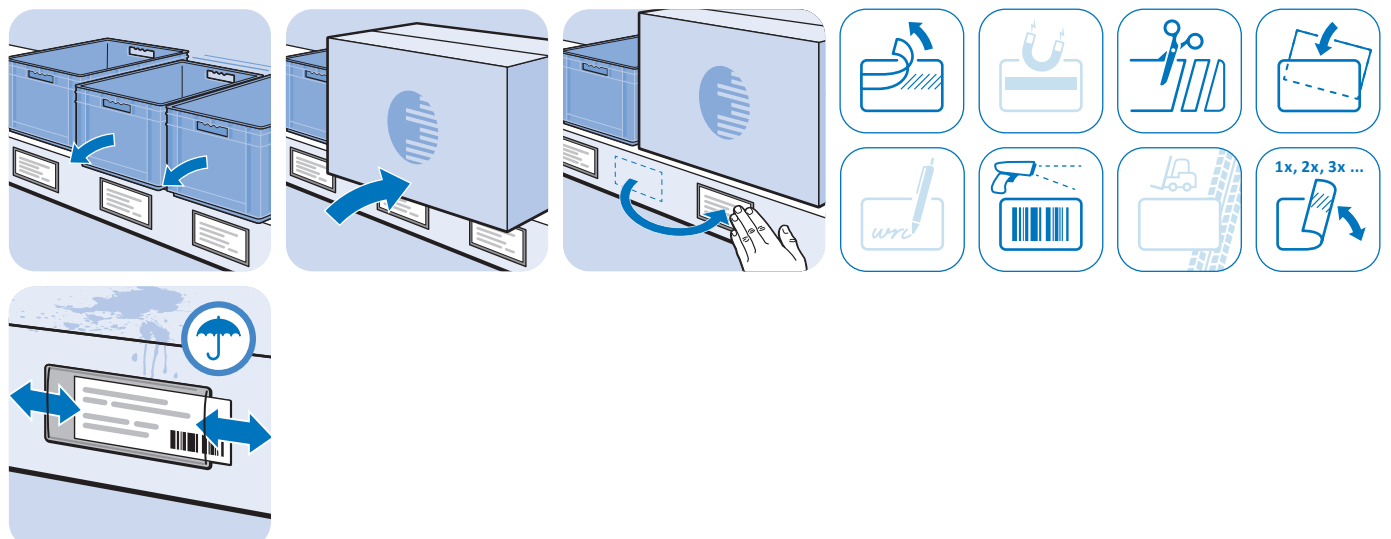
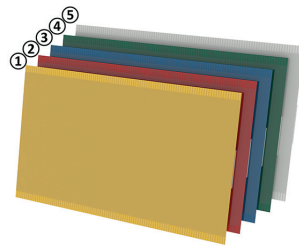
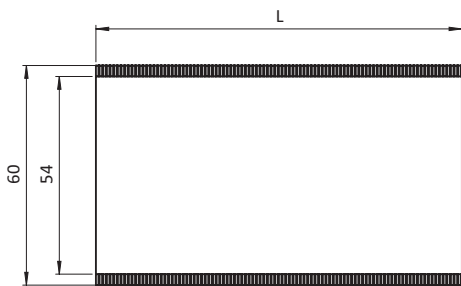

Fig.	L [mm]	Color	Weight [g]	Part #
①	100.0	Yellow ≈ RAL 1018	2.8	02021E60100SA15
②	100.0	Red ≈ RAL 3020	2.8	02021E60100SA31
③	100.0	Blue ≈ RAL 5017	2.8	02021E60100SA55
④	100.0	Green ≈ RAL 6016	2.8	02021E60100SA63
⑤	100.0	White ≈ RAL 9003	2.8	02021E60100SA93
①	200.0	Yellow ≈ RAL 1018	5.7	02021E60200SA15
②	200.0	Red ≈ RAL 3020	5.7	02021E60200SA31
③	200.0	Blue ≈ RAL 5017	5.7	02021E60200SA55
④	200.0	Green ≈ RAL 6016	5.7	02021E60200SA63
⑤	200.0	White ≈ RAL 9003	5.7	02021E60200SA93
①	300.0	Yellow ≈ RAL 1018	8.5	02021E60300SA15
②	300.0	Red ≈ RAL 3020	8.5	02021E60300SA31
③	300.0	Blue ≈ RAL 5017	8.5	02021E60300SA55
④	300.0	Green ≈ RAL 6016	8.5	02021E60300SA63
⑤	300.0	White ≈ RAL 9003	8.5	02021E60300SA93



SIDE OPEN MAGNETIC LABEL ENVELOPE 60 - 2.4"

MODEL	Magnetic
DESCRIPTION	To hold labels; For magnetic mounting on metallic surfaces, e.g. shelves; Side open only for special protection against wet and dust, tear-resistant and stretchable transparent foil with restoring capacity, scanner-compatible
MATERIAL	Label envelope: Plastic, PVC Magnetic strip
COLOR	Yellow, red, blue, green, white
PACK QUANTITY	50 pieces



2

Fig.	L [mm]	Color	Weight [g]	Part #
①	100.0	Yellow ≈ RAL 1018	13.7	02021E60100SM15
②	100.0	Red ≈ RAL 3020	13.7	02021E60100SM31
③	100.0	Blue ≈ RAL 5017	13.7	02021E60100SM55
④	100.0	Green ≈ RAL 6016	13.7	02021E60100SM63
⑤	100.0	White ≈ RAL 9003	13.7	02021E60100SM93
①	200.0	Yellow ≈ RAL 1018	28.9	02021E60200SM15
②	200.0	Red ≈ RAL 3020	28.9	02021E60200SM31
③	200.0	Blue ≈ RAL 5017	28.9	02021E60200SM55
④	200.0	Green ≈ RAL 6016	28.9	02021E60200SM63
⑤	200.0	White ≈ RAL 9003	28.9	02021E60200SM93
①	300.0	Yellow ≈ RAL 1018	43.3	02021E60300SM15
②	300.0	Red ≈ RAL 3020	43.3	02021E60300SM31
③	300.0	Blue ≈ RAL 5017	43.3	02021E60300SM55
④	300.0	Green ≈ RAL 6016	43.3	02021E60300SM63
⑤	300.0	White ≈ RAL 9003	43.3	02021E60300SM93

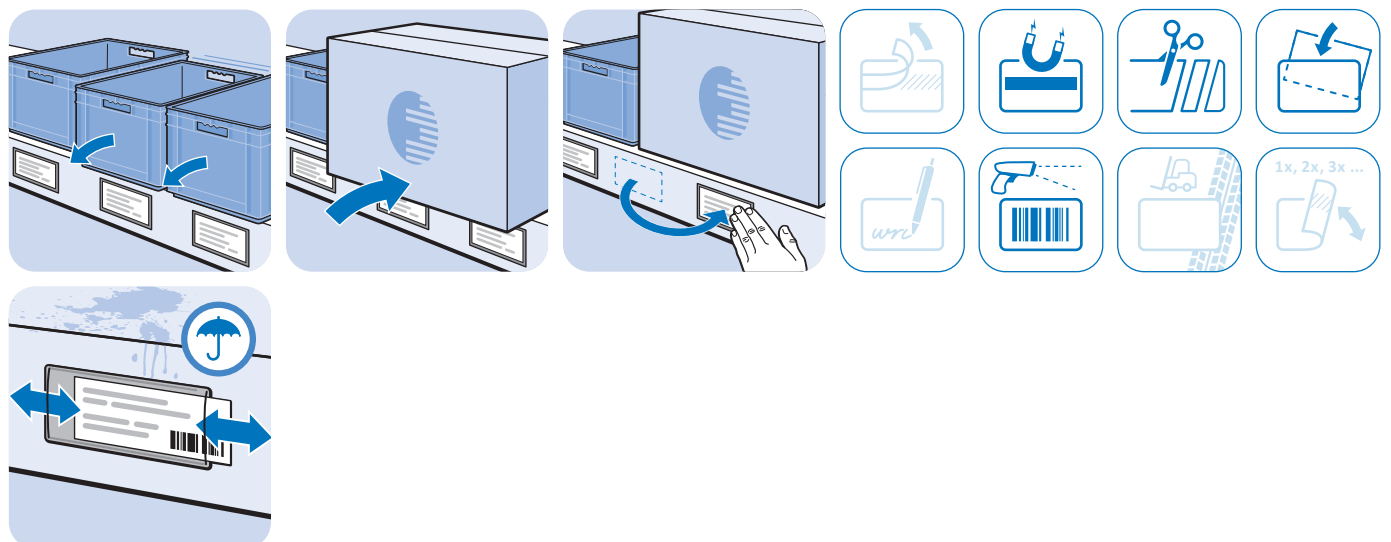

VISUAL MANAGEMENT



Floor Markings

3

Floor Markings



Floor Marking Tape 50

77

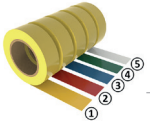

Floor Marking Tape 75

78

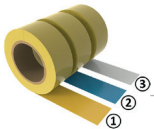

Floor Marking Tape 100

79



Temporary Floor Marking Tape 50 tesa® 60760

80

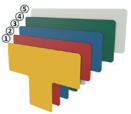

Floor Marking T-shape 50

83

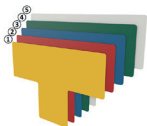

Floor Marking T-shape 75

84

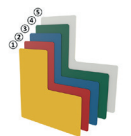

Floor Marking L-shape 50

85

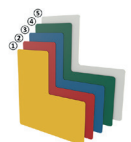

Floor Marking L-shape 75

86











Floor Marking I-shape 50

87

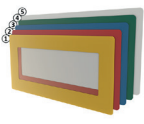

Floor Marking I-shape 75

88

	Floor Marking I-shape 100	89
	Floor Marking Foot Shape	90
	Floor Window DIN A5 - 5.8" x 8.3"	91
	Floor Window 1/3 DIN A4 Portrait - 8.3" x 3.9"	92
	Floor Window DIN A4 - 8.3" x 11.7"	93
	Floor Window 1/2 DIN A4 Landscape - 11.7" x 4.1"	94
	No Forklift Traffic Floor Sign	97
	No Stopping Floor Sign	98
	No Entry Floor Sign	99
	No Smoking Floor Sign	100



No Pedestrian Floor Sign

101



No Placing or Storing Floor Sign

102



Wear Hearing Protection Floor Sign

103



Safety Vest Required Floor Sign

104



Traffic Arrow Floor Sign

105



Hard Hat Area Floor Sign

106



Safety Glasses Required Floor Sign

107



Safety Shoes Required Floor Sign

108



Pedestrian Route Floor Sign

109



German Drive Slowly Floor Sign "Schritt fahren"

110



Stop Floor Sign

111



Caution Forklift Zone Floor Sign

112



Warning Slippery Surface Floor Sign

113

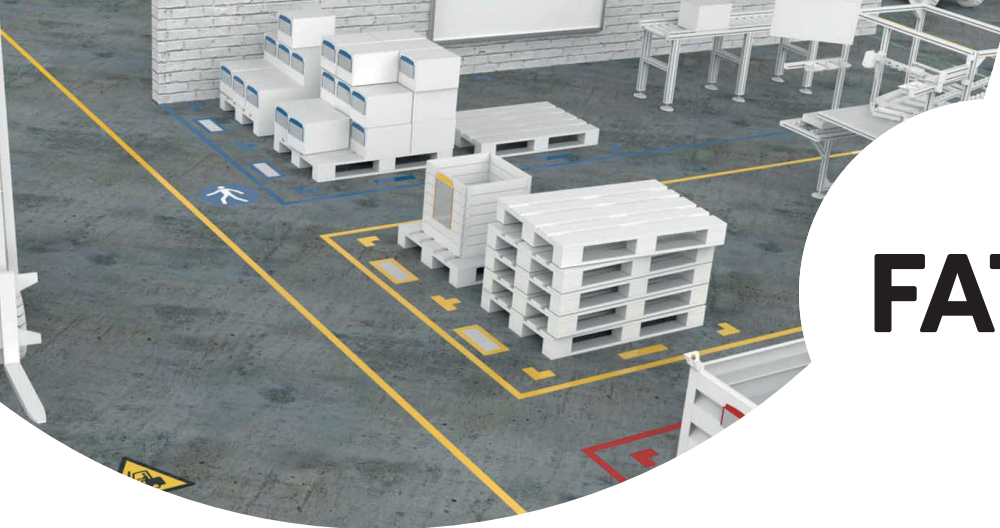

FATH

FLOOR MARKINGS FOR WAREHOUSES AND PRODUCTION FACILITIES!

TIP

BENEFITS:

- Simplified navigation
- Visual guidance
- Short search times – more efficient processes
- Quick and easy identification of materials
- Language barriers are overcome
- Accessibility to important areas

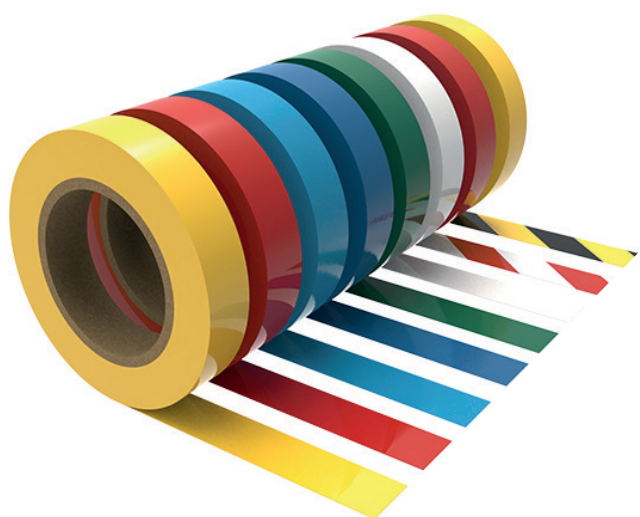

You see it every day:

Ground markings are indispensable in all areas of production, logistics, and road traffic. In addition to the safety aspects, the **FATH** floor markings have another key benefit: They contribute to the efficient running of production processes. Entirely in the spirit of lean production.

**Simpler than you think:
Use floor markings in a target-oriented manner**

Click here to access the FATH checklist and properly implement floor markings within your organization.

tip-floor-marking.fath24.com





FATH

SELF-ADHESIVE FLOOR MARKING TAPES

FATH Floor Marking Tapes for quick and durable marking



- Outstanding adhesive strength
- Forklift-resilient
- Suitable for virtually all industrial floors
- Removable without leaving residue
- Very dimensionally stable: adhesion without prior marking
- Available in all relevant colors

HIGHLIGHTS

With **FATH** self-adhesive Floor Marking Tapes, you can mark surfaces easily and safely. One of the most important functions of floor marking is separating vehicle routes and walkways. Clearly marked walkways ensure that employees and visitors stay safe if industrial trucks or forklifts are moving around the production area or warehouse.

You will comply with the obligation to visually separate vehicle routes from walkways with **FATH** Floor Marking Tapes. ASR A1.3 specifies that vehicle route boundaries should be delimited by marking strips at least 5 cm wide.

Stair steps can also be clearly marked with adhesive tape in signal colors to minimize the risk of falling.

Full flexibility with new production requirements: The self-adhesive floor marking tapes can

be removed from the floor without leaving any residue when production changeovers, restructurings or plant expansions are pending. The floor remains intact after removing the adhesive tape because no chemicals or acidic substances are required to remove them. Leased buildings, warehouses and spaces can also be temporarily labeled without causing any consequential damage.

CLEARLY
MARKED

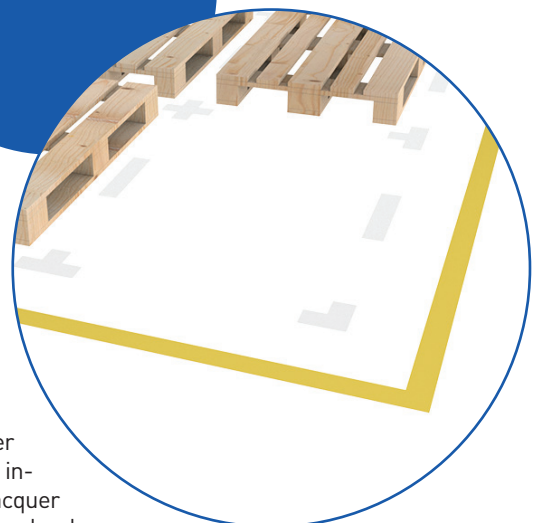

Floor marking tapes: forklift-resilient and instantly affixed

The dimensionally stable **FATH** Floor Marking Tapes can be cut to fit your needs and affixed to industrial floors without prior marking. Vehicles can drive over them immediately, and they are easy to clean. They are suitable for almost all industrial floors and surfaces such as stone, concrete or metal. Unlike paint or lacquer markings, there are no long drying times and no unpleasant odors. Thanks to the durable plastic surface suitable for industrial use, the floor marking tapes withstand heavy use by forklift trucks.

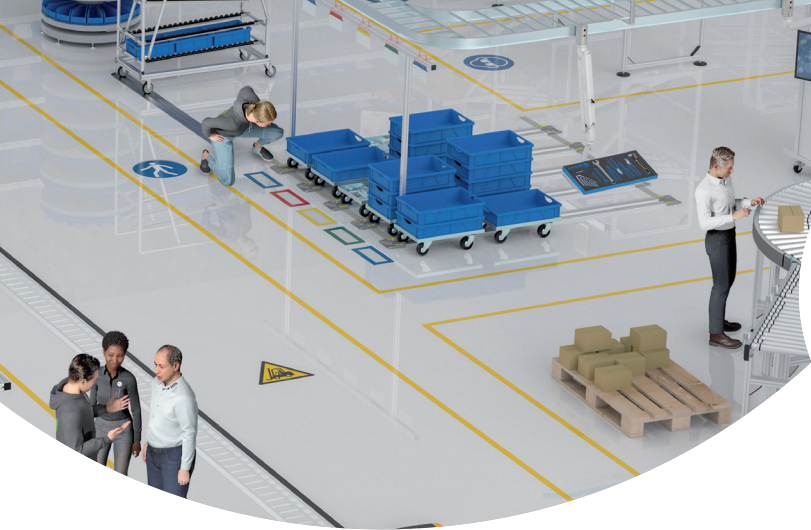

FATH

Highly durable multi-colored floor marking tapes

Thanks to a new printing concept, the multi-colored **FATH** Floor Marking Tapes are extremely durable. The color print is applied on the inside and is covered by a transparent film. This means that the print image is fully enclosed between the film and the adhesive and is thus permanently protected against wear and scratches, even after long use and heavy stress on the surface.

Color coding system for safe visualization

FATH Floor Marking Tapes are available in rolls in widths of 50, 75 and 100 mm and in all important marking colors – in single color and two-color versions. This enables companies to set up a secure color coding system for walkways, separate areas, storing spaces, parking spaces and entire areas in production plants and warehouses. When used correctly, the selected colors provide a largely intuitive recognition of the marked areas.

Versions:

The self-adhesive **FATH** Floor Marking Tapes are available as rolls in the following versions:

Roll:

- Length: 50 m
- Width: 50 mm / 75 mm / 100 mm

Colors:

- ① yellow
- ② red
- ③ light blue
- ④ blue
- ⑤ green
- ⑥ white
- ⑦ red / white
- ⑧ black / yellow

The **FATH** floor marking tapes are also available in the width 50 mm as temporary tape TESA® 60760. Here the length is 33 mm on a roll.

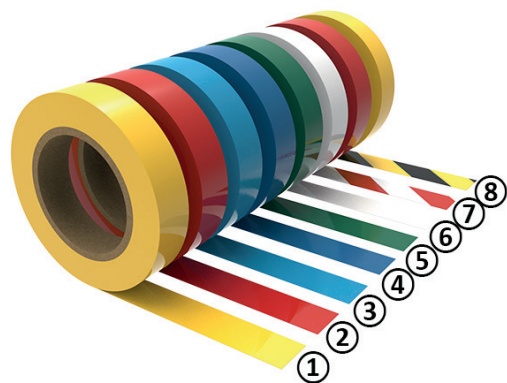

Would you like to learn more about **FATH** Floor Marking Tapes?

floor-marking-tape.fath24.com

FLOOR MARKING TAPE 50

MODEL	Diverse colors
DESCRIPTION	For easy and reliable marking of path boundaries, stairs, parking / storage / working areas etc., self-adhesive; Forklift-resistant and stable floor marking with outstanding adhesive strength, suitable for almost all industrial floors, removable without leaving residue
MATERIAL	Plastic PVC
COLOR	Yellow, red, blue, green, white, black / yellow, red / white
FASTENING	Self-adhesive surface on the backside
PACK QUANTITY	50 meters (spool)

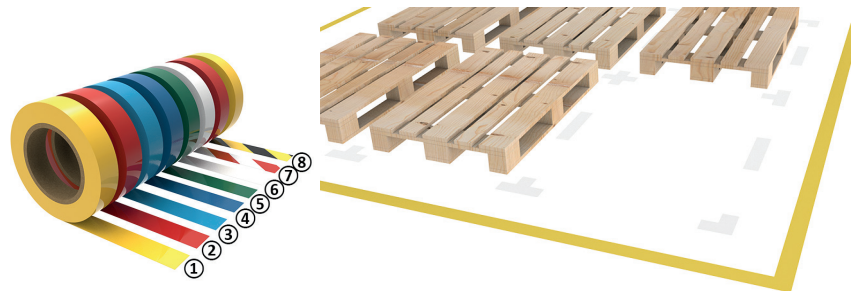
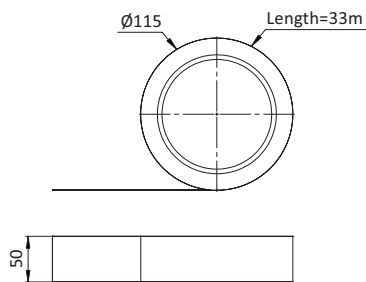
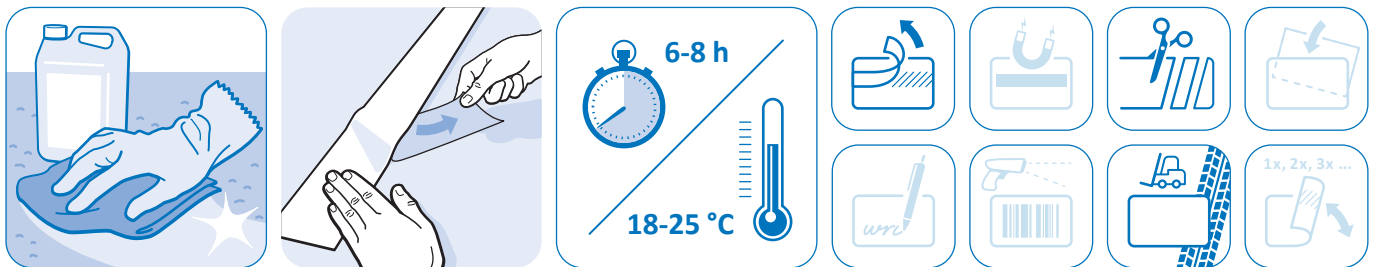

Fig.	Color	Weight [g]	Part #
①	Yellow ≈ RAL 1018	1664.0	0203T05015
②	Red ≈ RAL 3020	1664.0	0203T05031
④	Blue ≈ RAL 5017	1664.0	0203T05055
⑤	Green ≈ RAL 6016	1664.0	0203T05063
⑧	Black / yellow	1664.0	0203T0501591
⑦	Red / white	1664.0	0203T0503193
③	Blue ≈ RAL 5012	1664.0	0203T05056
⑥	White ≈ RAL 9003	1664.0	0203T05093

3



FLOOR MARKING TAPE 75

MODEL	Diverse colors
DESCRIPTION	For easy and reliable marking of path boundaries, stairs, parking / storage / working areas etc., self-adhesive; Forklift-resistant and stable floor marking with outstanding adhesive strength, suitable for almost all industrial floors, removable without leaving residue
MATERIAL	Plastic PVC
COLOR	Yellow, red, blue, green, white
FASTENING	Self-adhesive surface on the backside
PACK QUANTITY	50 meters (spool)

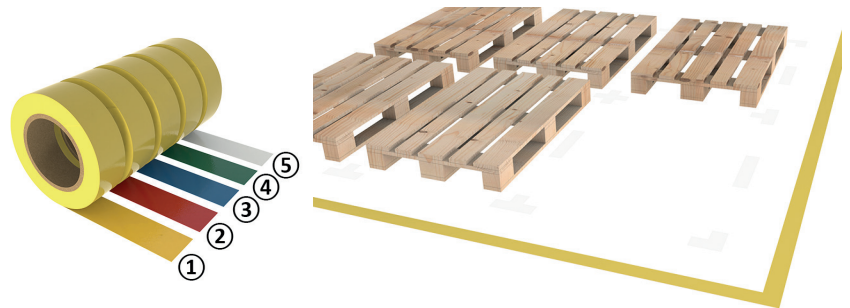
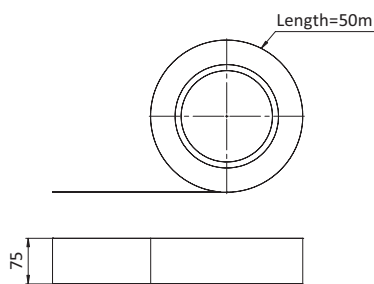
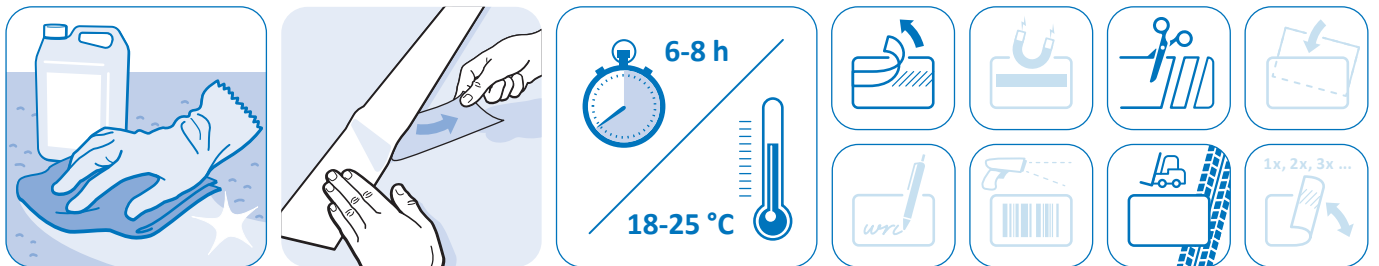

Fig.	Color	Weight [g]	Part #
①	Yellow ≈ RAL 1018	2500.0	0203T07515
②	Red ≈ RAL 3020	2500.0	0203T07531
③	Blue ≈ RAL 5017	2500.0	0203T07555
④	Green ≈ RAL 6016	2500.0	0203T07563
⑤	White ≈ RAL 9003	2500.0	0203T07593



FLOOR MARKING TAPE 100

MODEL	Diverse colors
DESCRIPTION	For easy and reliable marking of path boundaries, stairs, parking / storage / working areas etc., self-adhesive; Forklift-resistant and stable floor marking with outstanding adhesive strength, suitable for almost all industrial floors, removable without leaving residue
MATERIAL	Plastic PVC
COLOR	Yellow, blue, white
FASTENING	Self-adhesive surface on the backside
PACK QUANTITY	50 meters (spool)

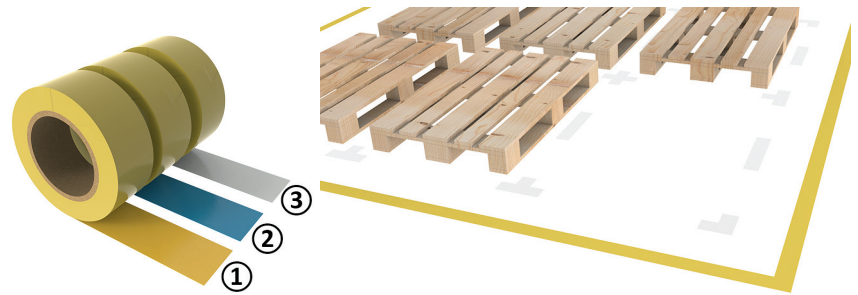
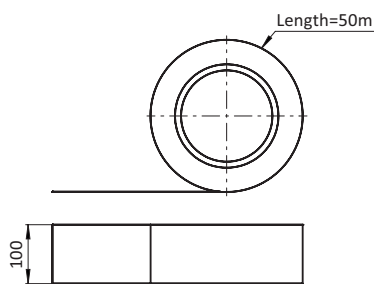
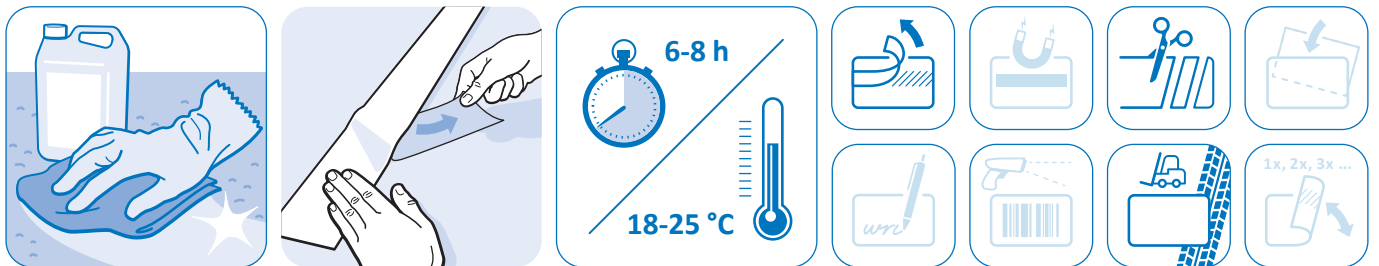

Fig.	Color	Weight [g]	Part #
①	Yellow ≈ RAL 1018	3220.0	0203T10015
②	Blue ≈ RAL 5012	3220.0	0203T10056
③	White ≈ RAL 9003	3220.0	0203T10093

3



TEMPORARY FLOOR MARKING TAPE 50 TESA® 60760

MODEL	Diverse colors
DESCRIPTION	For easy and reliable marking of path boundaries, stairs, parking / storage / working areas etc., self-adhesive; optimal for temporary marking as well as hazard identification on objects and industrial floors, removable without leaving residue
MATERIAL	Plastic PVC
COLOR	Yellow, red, blue, luminous green, white, black / yellow, red / white
FASTENING	Self-adhesive surface on the backside
PACK QUANTITY	198 meters (6 spools at 33 m)

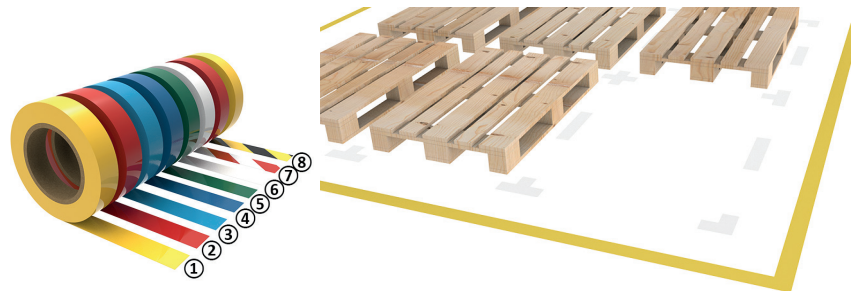
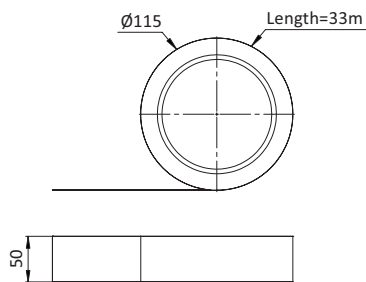
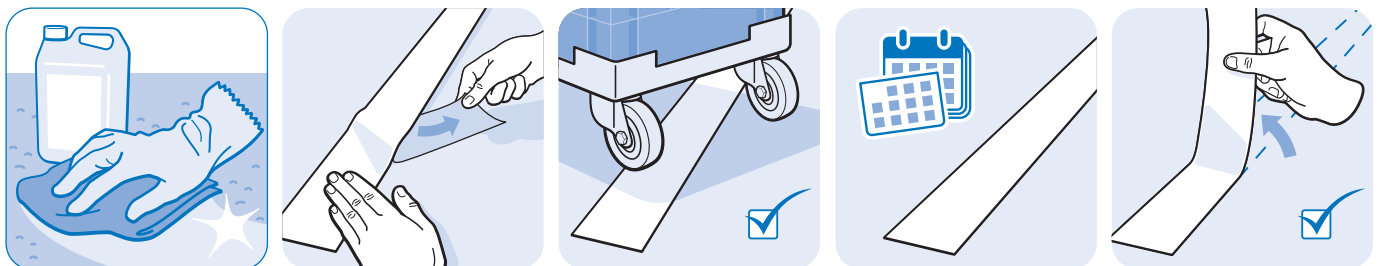

Fig.	Color	Weight [g]	Part #
①	Yellow	341.0	0203TT05015
②	Red	341.0	0203TT05031
③	Blue	341.0	0203TT05055
④	Luminous green	341.0	0203TT05065
⑤	White	341.0	0203TT05093
⑥	Red / white	341.0	0203TT0503193
⑦	Black / yellow	341.0	0203TT0509115





FATH

FLOOR MARKING SHAPES AND FLOOR WINDOWS

Flexible and lean:

Mark surfaces with self-adhesive **FATH** Floor Marking Shapes and Floor Windows



- High adhesion and forklift-resistant
- Suitable for virtually all industrial floors
- Pre-punched shapes in L/T/I/foot shape
- Windows in different DIN formats
- Scannable
- Very dimensionally stable: adhesion without prior marking
- Available in several colors

HIGHLIGHTS

With the self-adhesive, dimensionally stable **FATH** Floor Marking Shapes and Floor Windows, you can implement visualizations immediately. They are simply stuck on at the desired location, are immediately available for foot or vehicle traffic and are easy to clean. They are suitable for almost all industrial floors and surfaces such as stone, concrete or metal.

Unlike paint or lacquer markings, there are no long drying times and no unpleasant odors. Thanks to the durable plastic surface suitable for industrial use, the floor shapes can withstand heavy stress from forklift trucks. Ideal for designating pallet storing positions.

Flexibility in case of new production requirements: The floor marking shapes and floor windows can be removed from the floor without

leaving any residue when production changes, restructurings or plant expansions are pending. The floor remains intact, as no chemicals or acidic substances are required to remove the adhesive material. Leased buildings, warehouses and spaces can also be temporarily labeled without causing any consequential damage.

DEFINED PROVISIONING

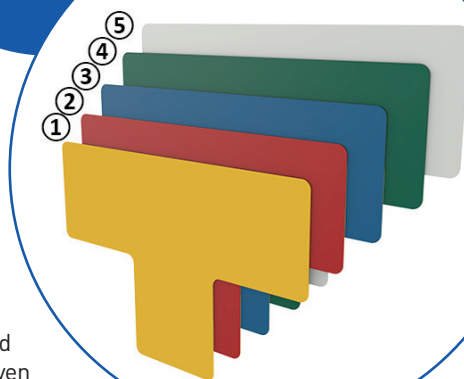

FATH Floor Marking Shapes: pre-punched for immediate application

The practical **FATH** Floor Marking Shapes come pre-punched. Easy to attach, these provide secure and effective storage space labeling in production and warehousing. After they are attached, the floor shapes can be walked on and driven on immediately. Areas for pallets, shelving, containers, dollies, etc. can be precisely marked – creating a strong visual effect. Generally the L shape is used for side boundaries and the T shape is used for demarcation marks between two storage positions. Floor labeling allows you to create a clear structuring of surfaces and areas, reduce the amount of floor space needed and assist staff in working efficiently.



FATH

FATH Floor Windows: forklift-resilient, scratch-resistant and scannable

What's special about **FATH** Floor Windows: The print for the colored frame is applied on the inside. This allows the signal color to be fully enclosed and thus provides permanent protection against wear and scratches. The color also remains visible after prolonged use – even heavy use in areas driven over cannot harm the floor windows. Documents in various sizes up to DIN A4 are inserted behind the transparent plastic window and can be scanned through the viewing window. The 40 mm frame width ensures immediate recognition, even from a distance. The document assures you that the material is available in the right position.

Designing individual signs with FATH Floor Windows

FATH Floor Windows are also ideal for designing individual signs or warning notices based on your needs. Simply place the printed documents with the required information behind the viewing window and stick on the bottom window.

FATH tip:

When the floor marking shapes are affixed with a spacing of approx. 30 millimeters to the provisioning areas, they are well protected against wear and tear.

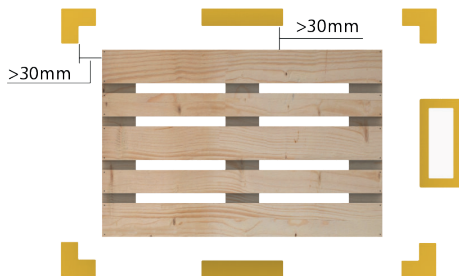

Versions

The self-adhesive floor marking shapes and floor windows are available in the following designs:

FATH Floor Marking Shapes:

Formats:

- T-shape
- L-shape
- I-shape
- Foot shape

Colors:

- ① yellow
- ② red
- ③ blue
- ④ green
- ⑤ white

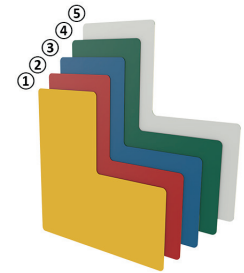

FATH Floor Windows:

Formats:

- DIN A4
- DIN A5
- 1/2 DIN A4 landscape
- 1/2 DIN A4 portrait

Colors:

- ① yellow
- ② red
- ③ blue
- ④ green
- ⑤ white

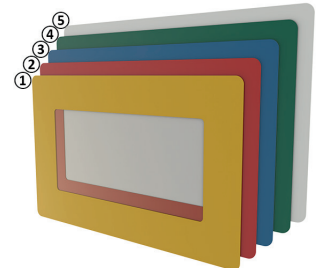

Would you like to learn more about **FATH** Floor Marking Shapes and Floor Windows?

shape-window.fath24.com

FLOOR MARKING T-SHAPE 50

MODEL	Diverse colors
DESCRIPTION	For easy and reliable marking of parking / storage areas etc., self-adhesive; Forklift-resistant and stable floor marking with outstanding adhesive strength, suitable for almost all industrial floors, removable without leaving residue
MATERIAL	Plastic PVC
COLOR	Yellow, red, blue, green, white
FASTENING	Self-adhesive surface on the backside
PACK QUANTITY	40 pieces
TIP	Suitable floor marking tape 50 see 0203T05015

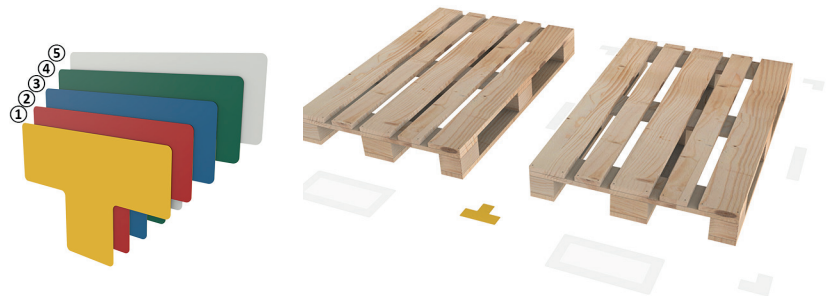
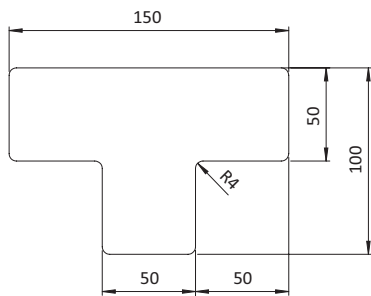

Fig.	Color	Weight [g]	Part #
①	Yellow ≈ RAL 1018	7.0	0203HT05015
②	Red ≈ RAL 3020	7.0	0203HT05031
③	Blue ≈ RAL 5017	7.0	0203HT05055
④	Green ≈ RAL 6016	7.0	0203HT05063
⑤	White ≈ RAL 9003	7.0	0203HT05093



FLOOR MARKING T-SHAPE 75

MODEL	Diverse colors
DESCRIPTION	For easy and reliable marking of parking / storage areas etc., self-adhesive; Forklift-resistant and stable floor marking with outstanding adhesive strength, suitable for almost all industrial floors, removable without leaving residue
MATERIAL	Plastic PVC
COLOR	Yellow, red, blue, green, white
FASTENING	Self-adhesive surface on the backside
PACK QUANTITY	40 pieces
TIP	Suitable floor marking tape 75 see 0203T07515

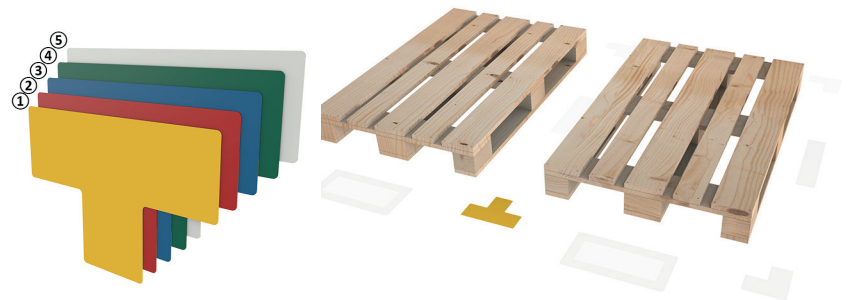
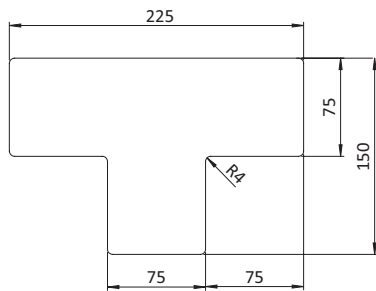

Fig.	Color	Weight [g]	Part #
①	Yellow ≈ RAL 1018	15.0	0203HT07515
②	Red ≈ RAL 3020	15.0	0203HT07531
③	Blue ≈ RAL 5017	15.0	0203HT07555
④	Green ≈ RAL 6016	15.0	0203HT07563
⑤	White ≈ RAL 9003	15.0	0203HT07593



FLOOR MARKING L-SHAPE 50

MODEL	Diverse colors
DESCRIPTION	For easy and reliable marking of parking / storage areas etc., self-adhesive; Forklift-resistant and stable floor marking with outstanding adhesive strength, suitable for almost all industrial floors, removable without leaving residue
MATERIAL	Plastic PVC
COLOR	Yellow, red, blue, green, white
FASTENING	Self-adhesive surface on the backside
PACK QUANTITY	40 pieces
TIP	Suitable floor marking tape 50 see 0203T05015

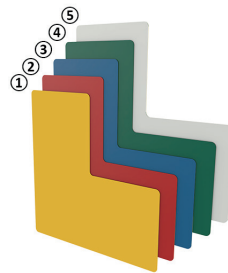
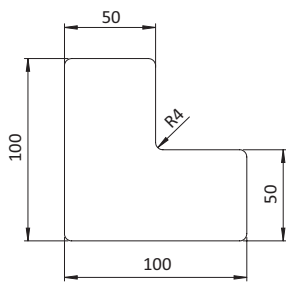

Fig.	Color	Weight [g]	Part #
①	Yellow ≈ RAL 1018	5.0	0203HL05015
②	Red ≈ RAL 3020	5.0	0203HL05031
③	Blue ≈ RAL 5017	5.0	0203HL05055
④	Green ≈ RAL 6016	5.0	0203HL05063
⑤	White ≈ RAL 9003	5.0	0203HL05093



FLOOR MARKING L-SHAPE 75

MODEL	Diverse colors
DESCRIPTION	For easy and reliable marking of parking / storage areas etc., self-adhesive; Forklift-resistant and stable floor marking with outstanding adhesive strength, suitable for almost all industrial floors, removable without leaving residue
MATERIAL	Plastic PVC
COLOR	Yellow, red, blue, green, white
FASTENING	Self-adhesive surface on the backside
PACK QUANTITY	40 pieces
TIP	Suitable floor marking tape 75 see 0203T07515

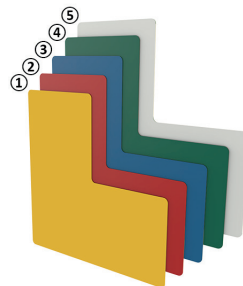
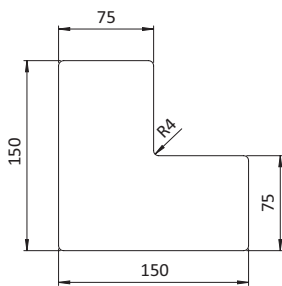

Fig.	Color	Weight [g]	Part #
①	Yellow ≈ RAL 1018	12.0	0203HL07515
②	Red ≈ RAL 3020	12.0	0203HL07531
③	Blue ≈ RAL 5017	12.0	0203HL07555
④	Green ≈ RAL 6016	12.0	0203HL07563
⑤	White ≈ RAL 9003	12.0	0203HL07593



FLOOR MARKING I-SHAPE 50

MODEL	Diverse colors
DESCRIPTION	For easy and reliable marking of parking / storage areas etc., self-adhesive; Forklift-resistant and stable floor marking with outstanding adhesive strength, suitable for almost all industrial floors, removable without leaving residue
MATERIAL	Plastic PVC
COLOR	Yellow, red, blue, green, white
FASTENING	Self-adhesive surface on the backside
PACK QUANTITY	40 pieces
TIP	Suitable floor marking tape 50 see 0203T05015

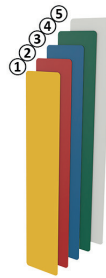
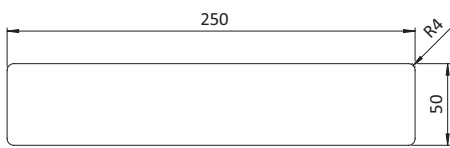

Fig.	Color	Weight [g]	Part #
①	Yellow ≈ RAL 1018	9.0	0203HI05015
②	Red ≈ RAL 3020	9.0	0203HI05031
③	Blue ≈ RAL 5017	9.0	0203HI05055
④	Green ≈ RAL 6016	9.0	0203HI05063
⑤	White ≈ RAL 9003	9.0	0203HI05093



FLOOR MARKING I-SHAPE 75

MODEL	Diverse colors
DESCRIPTION	For easy and reliable marking of parking / storage areas etc., self-adhesive; Forklift-resistant and stable floor marking with outstanding adhesive strength, suitable for almost all industrial floors, removable without leaving residue
MATERIAL	Plastic PVC
COLOR	Yellow, red, blue, green, white
FASTENING	Self-adhesive surface on the backside
PACK QUANTITY	40 pieces
TIP	Suitable floor marking tape 75 see 0203T07515

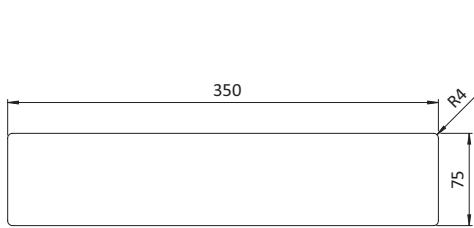
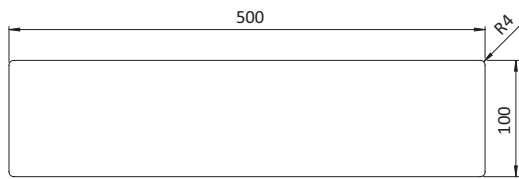

Fig.	Color	Weight [g]	Part #
①	Yellow ≈ RAL 1018	18.0	0203HI07515
②	Red ≈ RAL 3020	18.0	0203HI07531
③	Blue ≈ RAL 5017	18.0	0203HI07555
④	Green ≈ RAL 6016	18.0	0203HI07563
⑤	White ≈ RAL 9003	18.0	0203HI07593



FLOOR MARKING I-SHAPE 100

MODEL	Diverse colors
DESCRIPTION	For easy and reliable marking of parking / storage areas etc., self-adhesive; Forklift-resistant and stable floor marking with outstanding adhesive strength, suitable for almost all industrial floors, removable without leaving residue
MATERIAL	Plastic PVC
COLOR	White
FASTENING	Self-adhesive surface on the backside
PACK QUANTITY	40 pieces
TIP	Suitable floor marking tape 100 see 0203T10093



	Color	Weight [g]	Part #
	White ≈ RAL 9003	25.0	0203HI10093



FLOOR MARKING FOOT SHAPE 90

MODEL	Diverse colors
DESCRIPTION	For easy and reliable marking of parking / storage areas etc., self-adhesive; Forklift-resistant and stable floor marking with outstanding adhesive strength, suitable for almost all industrial floors, removable without leaving residue
MATERIAL	Plastic PVC
COLOR	Yellow, red, blue, green, white
FASTENING	Self-adhesive surface on the backside
PACK QUANTITY	40 pieces

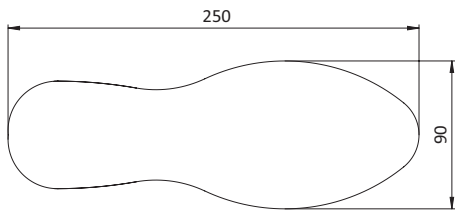

Fig.	Color	Weight [g]	Part #
①	Yellow ≈ RAL 1018	11.0	0203HF09015
②	Red ≈ RAL 3020	11.0	0203HF09031
③	Blue ≈ RAL 5017	11.0	0203HF09055
④	Green ≈ RAL 6016	11.0	0203HF09063
⑤	White ≈ RAL 9003	11.0	0203HF09093



FLOOR WINDOW DIN A5 - 5.8" X 8.3"

MODEL	Diverse colors
DESCRIPTION	For easy and reliable marking of parking / storage areas etc., self-adhesive; Forklift-resistant and stable floor window with outstanding adhesive strength, suitable for almost all industrial floors, removable without leaving residue Scanner-compatible
MATERIAL	Plastic PVC
COLOR	Yellow, red, blue, green, white
FASTENING	Self-adhesive strip on the backside
PACK QUANTITY	10 pieces

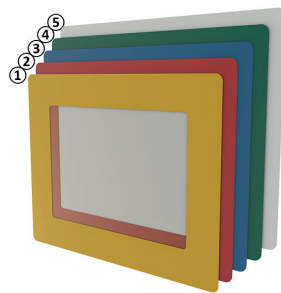
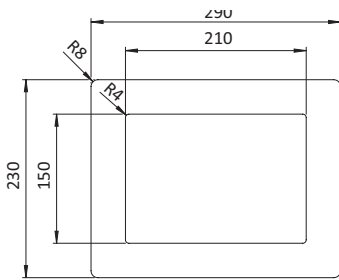

Fig.	Color	Weight [g]	Part #
①	Yellow ≈ RAL 1018	45.0	0203WRA515
②	Red ≈ RAL 3020	45.0	0203WRA531
③	Blue ≈ RAL 5017	45.0	0203WRA555
④	Green ≈ RAL 6016	45.0	0203WRA563
⑤	White ≈ RAL 9003	45.0	0203WRA593

3

FLOOR WINDOW 1/3 DIN A4 PORTRAIT - 8.3" X 3.9"

MODEL	Diverse colors
DESCRIPTION	For easy and reliable marking of parking / storage areas etc., self-adhesive; Forklift-resistant and stable floor window with outstanding adhesive strength, suitable for almost all industrial floors, removable without leaving residue Scanner-compatible
MATERIAL	Plastic PVC
COLOR	Yellow, red, blue, green, white
FASTENING	Self-adhesive strip on the backside
PACK QUANTITY	10 pieces

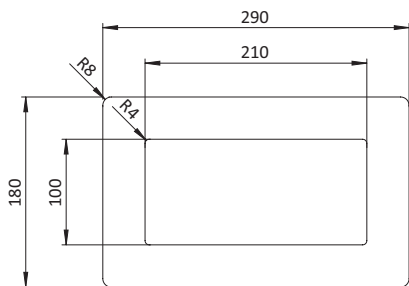

Fig.	Color	Weight [g]	Part #
①	Yellow ≈ RAL 1018	40.0	0203WRA1/315
②	Red ≈ RAL 3020	40.0	0203WRA1/331
③	Blue ≈ RAL 5017	40.0	0203WRA1/355
④	Green ≈ RAL 6016	40.0	0203WRA1/363
⑤	White ≈ RAL 9003	40.0	0203WRA1/393

FLOOR WINDOW DIN A4 - 8.3" X 11.7"

MODEL	Diverse colors
DESCRIPTION	For easy and reliable marking of parking / storage areas etc., self-adhesive; Forklift-resistant and stable floor window with outstanding adhesive strength, suitable for almost all industrial floors, removable without leaving residue Scanner-compatible
MATERIAL	Plastic PVC
COLOR	Yellow, red, blue, green, white
FASTENING	Self-adhesive strip on the backside
PACK QUANTITY	10 pieces

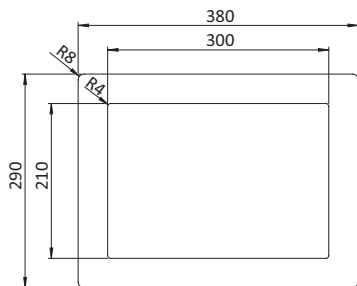

Fig.	Color	Weight [g]	Part #
①	Yellow ≈ RAL 1018	70.0	0203WRA415
②	Red ≈ RAL 3020	70.0	0203WRA431
④	Blue ≈ RAL 5017	70.0	0203WRA455
⑤	Green ≈ RAL 6016	70.0	0203WRA463
③	Blue ≈ RAL 5012	70.0	0203WRA456
⑥	White ≈ RAL 9003	70.0	0203WRA493

3

FLOOR WINDOW 1/2 DIN A4 LANDSCAPE - 11.7" X 4.1"

MODEL	Diverse colors
DESCRIPTION	For easy and reliable marking of parking / storage areas etc., self-adhesive; Forklift-resistant and stable floor window with outstanding adhesive strength, suitable for almost all industrial floors, removable without leaving residue Scanner-compatible
MATERIAL	Plastic PVC
COLOR	Yellow, red, blue, green, white
FASTENING	Self-adhesive strip on the backside
PACK QUANTITY	10 pieces

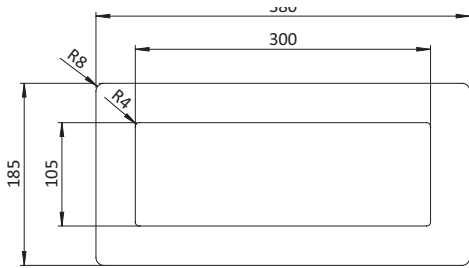

Fig.	Color	Weight [g]	Part #
①	Yellow ≈ RAL 1018	50.0	0203WRA1/215
②	Red ≈ RAL 3020	50.0	0203WRA1/231
③	Blue ≈ RAL 5017	50.0	0203WRA1/255
④	Green ≈ RAL 6016	50.0	0203WRA1/263
⑤	White ≈ RAL 9003	50.0	0203WRA1/293



FATH

FLOOR SIGNS

Safe and lean:
Easily highlight danger zones with self-adhesive FATH Floor Signs



- Pictograms as per ASR standards
- Outstanding adhesive strength
- Forklift-resilient and extremely durable
- Suitable for virtually all industrial floors
- All common prohibition, mandatory, warning and information signs
- Strong signaling effect

HIGHLIGHTS

With **FATH** Floor Signs, you can comply right away with the applicable regulations for the marking of hazardous zones. The floor signs can be walked on and driven on immediately after gluing.

The pictograms on the **FATH** Floor Signs are designed in compliance with ASR standards. The floor signs are 450 millimeters in size and ensure that the icons can be seen from a distance – when viewed from a forklift, for example. This means that they comply with the German Technical Workplace Regulations (ASR) and meet the requirements specified in the German Workplaces Ordinance (ArbStättV), which serve to ensure safety and health protection for employees.

Full flexibility for reorganizations: These self-adhesive floor signs can be detached from the floor without leaving residue if restructurings or plant expansions are pending. The floor remains intact after the signs are removed, since no chemicals or acid-based substances are required to remove them. Buildings, warehouses, and surfaces can be labeled permanently or temporarily without causing any damage.

INCREASE SAFETY



FATH's Floor Signs: self-adhesive and forklift-resilient

The self-adhesive, dimensionally stable **FATH** Floor Signs are easily affixed to the floor, can be driven over immediately and are easy to clean. They are suitable for virtually all industrial floors and surfaces. Unlike paint or lacquer markings, there are no long drying times and no unpleasant odors. Thanks to the adhesive applied across their entire back surface, these floor signs even permanently adhere to problematic surfaces.

Another advantage: **FATH** Floor Signs have a textured non-slip surface.



FATH

New printing method protects against scratches

What makes **FATH** Floor Signs special: The pictogram's color print is applied to the inside instead of on the outer surface and is then covered with a transparent protective film. This means that the image is fully enclosed between the film and the adhesive. It is permanently protected against wear and scratches, even after long use and heavy stress on the surface. The durable plastic surface is suitable for industrial use and can withstand heavy loads, such as forklifts driving over it.

FATH Floor Windows for customized warning signs

If you want to attach specific information or warnings on the floor, **FATH** Floor Windows are the ideal solution. You can use them to design your own customized warning signs that fit your needs. Simply place the printed sheets behind the transparent, scanner-compatible viewing window and affix the floor window. Different DIN formats and colors are available.



More about **FATH** Floor Windows:
shape-window.fath24.com

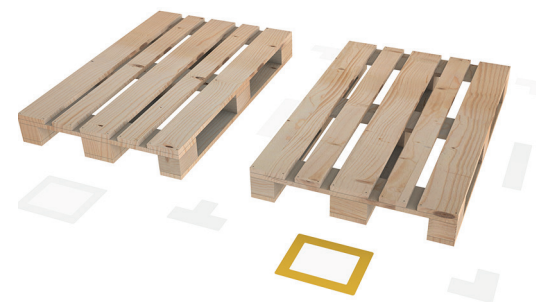

Versions

All common signs in the following categories are available:

- Prohibition signs
- Mandatory signs
- Warning and information signs



Would you like to learn more about **FATH** Floor Signs?

floor-sign.fath24.com

NO FORKLIFT TRAFFIC FLOOR SIGN

MODEL	Prohibitive Sign
DESCRIPTION	For fast and reliable safety marking according to ASR A1.3 / DIN EN ISO 7010, self-adhesive; Easy recognition from long distance; Forklift-resistant and slip-proof floor sign with outstanding adhesive strength, suitable for almost all industrial floors, removable without leaving residue
MATERIAL	Plastic PVC
COLOR	Red / white / black
FASTENING	Self-adhesive surface on the backside
PACK QUANTITY	1 piece

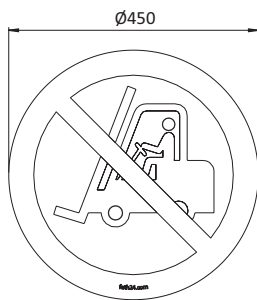

Weight [g]
174.0

Part #
0203SP01

3



NO STOPPING FLOOR SIGN

MODEL	Prohibitive Sign
DESCRIPTION	For fast and reliable safety marking according to ASR A1.3 / DIN EN ISO 7010, self-adhesive; Easy recognition from long distance; Forklift-resistant and slip-proof floor sign with outstanding adhesive strength, suitable for almost all industrial floors, removable without leaving residue
MATERIAL	Plastic PVC
COLOR	Red / blue
FASTENING	Self-adhesive surface on the backside
PACK QUANTITY	1 piece

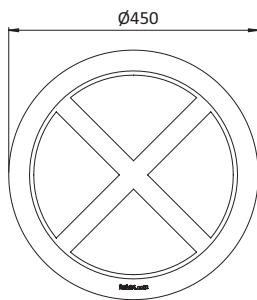

Weight [g]
174.0

Part #
0203SP02



NO ENTRY FLOOR SIGN

MODEL	Prohibitive Sign
DESCRIPTION	For fast and reliable safety marking according to ASR A1.3 / DIN EN ISO 7010, self-adhesive; Easy recognition from long distance; Forklift-resistant and slip-proof floor sign with outstanding adhesive strength, suitable for almost all industrial floors, removable without leaving residue
MATERIAL	Plastic PVC
COLOR	Red / white
FASTENING	Self-adhesive surface on the backside
PACK QUANTITY	1 piece

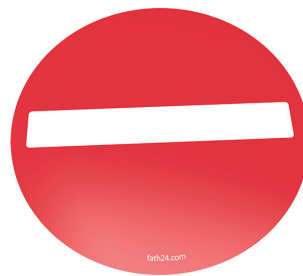
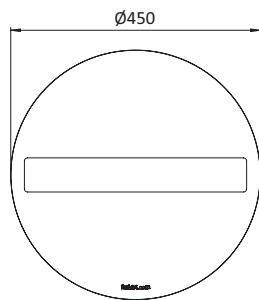

Weight [g]
174.0

Part #
0203SP03

3



NO SMOKING FLOOR SIGN

MODEL	Prohibitive Sign
DESCRIPTION	For fast and reliable safety marking according to ASR A1.3 / DIN EN ISO 7010, self-adhesive; Easy recognition from long distance; Forklift-resistant and slip-proof floor sign with outstanding adhesive strength, suitable for almost all industrial floors, removable without leaving residue
MATERIAL	Plastic PVC
COLOR	Red / white / black
FASTENING	Self-adhesive surface on the backside
PACK QUANTITY	1 piece

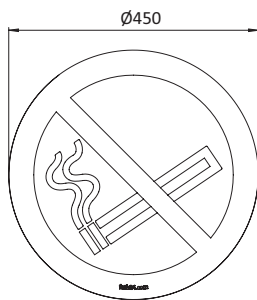

Weight [g]

Part #

174.0

0203SP04



NO PEDESTRIAN FLOOR SIGN

MODEL	Prohibitive Sign
DESCRIPTION	For fast and reliable safety marking according to ASR A1.3 / DIN EN ISO 7010, self-adhesive; Easy recognition from long distance; Forklift-resistant and slip-proof floor sign with outstanding adhesive strength, suitable for almost all industrial floors, removable without leaving residue
MATERIAL	Plastic PVC
COLOR	Red / white / black
FASTENING	Self-adhesive surface on the backside
PACK QUANTITY	1 piece



Weight [g]
174.0

Part #
0203SP05

3



NO PLACING OR STORING FLOOR SIGN

MODEL	Prohibitive Sign
DESCRIPTION	For fast and reliable safety marking according to ASR A1.3 / DIN EN ISO 7010, self-adhesive; Easy recognition from long distance; Forklift-resistant and slip-proof floor sign with outstanding adhesive strength, suitable for almost all industrial floors, removable without leaving residue
MATERIAL	Plastic PVC
COLOR	Red / white / black
FASTENING	Self-adhesive surface on the backside
PACK QUANTITY	1 piece

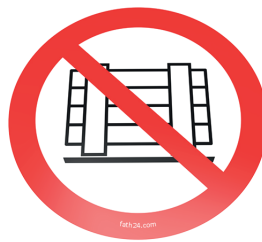
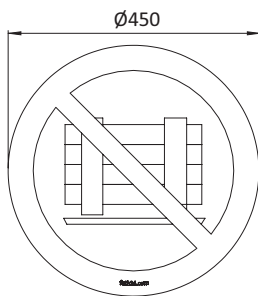

Weight [g]	Part #
174.0	0203SP06



WEAR HEARING PROTECTION FLOOR SIGN

MODEL	Mandatory Sign
DESCRIPTION	For fast and reliable safety marking according to ASR A1.3 / DIN EN ISO 7010, self-adhesive; Easy recognition from long distance; Forklift-resistant and slip-proof floor sign with outstanding adhesive strength, suitable for almost all industrial floors, removable without leaving residue
MATERIAL	Plastic PVC
COLOR	Blue / white
FASTENING	Self-adhesive surface on the backside
PACK QUANTITY	1 piece

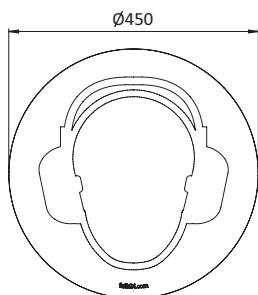

Weight [g]	Part #
174.0	0203SM01



SAFETY VEST REQUIRED FLOOR SIGN

MODEL	Mandatory Sign
DESCRIPTION	For fast and reliable safety marking according to ASR A1.3 / DIN EN ISO 7010, self-adhesive; Easy recognition from long distance; Forklift-resistant and slip-proof floor sign with outstanding adhesive strength, suitable for almost all industrial floors, removable without leaving residue
MATERIAL	Plastic PVC
COLOR	Blue / white
FASTENING	Self-adhesive surface on the backside
PACK QUANTITY	1 piece

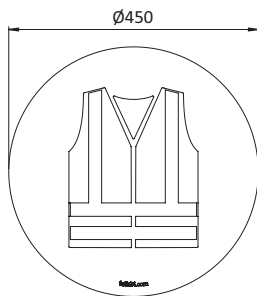

Weight [g]
174.0

Part #
0203SM02



TRAFFIC ARROW FLOOR SIGN

MODEL	Mandatory Sign
DESCRIPTION	For fast and reliable safety marking according to ASR A1.3 / DIN EN ISO 7010, self-adhesive; Easy recognition from long distance; Forklift-resistant and slip-proof floor sign with outstanding adhesive strength, suitable for almost all industrial floors, removable without leaving residue
MATERIAL	Plastic PVC
COLOR	Blue / white
FASTENING	Self-adhesive surface on the backside
PACK QUANTITY	1 piece

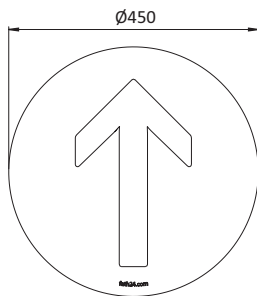

Weight [g]

174.0

Part #

0203SM03

3



HARD HAT AREA FLOOR SIGN

MODEL	Mandatory Sign
DESCRIPTION	For fast and reliable safety marking according to ASR A1.3 / DIN EN ISO 7010, self-adhesive; Easy recognition from long distance; Forklift-resistant and slip-proof floor sign with outstanding adhesive strength, suitable for almost all industrial floors, removable without leaving residue
MATERIAL	Plastic PVC
COLOR	Blue / white
FASTENING	Self-adhesive surface on the backside
PACK QUANTITY	1 piece

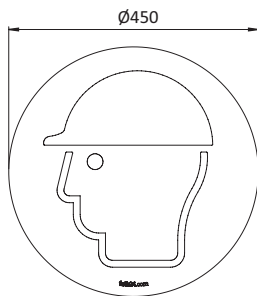

Weight [g]	Part #
174.0	0203SM04



SAFETY GLASSES REQUIRED FLOOR SIGN

MODEL	Mandatory Sign
DESCRIPTION	For fast and reliable safety marking according to ASR A1.3 / DIN EN ISO 7010, self-adhesive; Easy recognition from long distance; Forklift-resistant and slip-proof floor sign with outstanding adhesive strength, suitable for almost all industrial floors, removable without leaving residue
MATERIAL	Plastic PVC
COLOR	Blue / white
FASTENING	Self-adhesive surface on the backside
PACK QUANTITY	1 piece

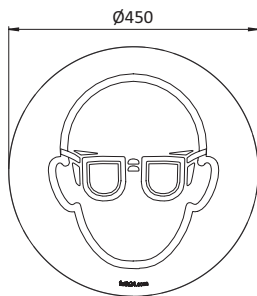

Weight [g]
174.0

Part #
0203SM05

3



SAFETY SHOES REQUIRED FLOOR SIGN

MODEL	Mandatory Sign
DESCRIPTION	For fast and reliable safety marking according to ASR A1.3 / DIN EN ISO 7010, self-adhesive; Easy recognition from long distance; Forklift-resistant and slip-proof floor sign with outstanding adhesive strength, suitable for almost all industrial floors, removable without leaving residue
MATERIAL	Plastic PVC
COLOR	Blue / white
FASTENING	Self-adhesive surface on the backside
PACK QUANTITY	1 piece

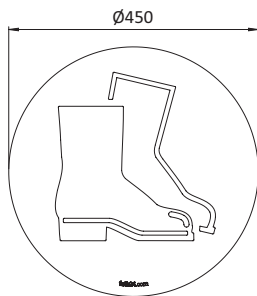

Weight [g]	Part #
174.0	0203SM06



PEDESTRIAN ROUTE FLOOR SIGN

MODEL	Mandatory Sign
DESCRIPTION	For fast and reliable safety marking according to ASR A1.3 / DIN EN ISO 7010, self-adhesive; Easy recognition from long distance; Forklift-resistant and slip-proof floor sign with outstanding adhesive strength, suitable for almost all industrial floors, removable without leaving residue
MATERIAL	Plastic PVC
COLOR	Blue / white
FASTENING	Self-adhesive surface on the backside
PACK QUANTITY	1 piece

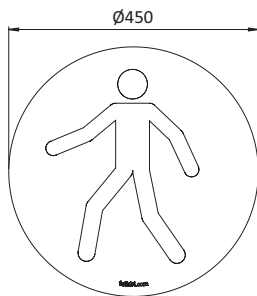

Weight [g]
174.0

Part #
0203SM07

3



GERMAN DRIVE SLOWLY FLOOR SIGN "SCHRITT FAHREN"

MODEL	Mandatory Sign
DESCRIPTION	For fast and reliable safety marking according to ASR A1.3 / DIN EN ISO 7010, self-adhesive; Easy recognition from long distance; Forklift-resistant and slip-proof floor sign with outstanding adhesive strength, suitable for almost all industrial floors, removable without leaving residue
MATERIAL	Plastic PVC
COLOR	Red / white / black
FASTENING	Self-adhesive surface on the backside
PACK QUANTITY	1 piece

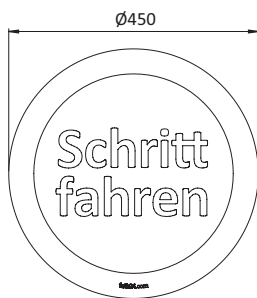

Weight [g]	Part #
174.0	0203SM08



STOP FLOOR SIGN

MODEL	Warning and Notice Sign
DESCRIPTION	For fast and reliable safety marking according to ASR A1.3 / DIN EN ISO 7010, self-adhesive; Easy recognition from long distance; Forklift-resistant and slip-proof floor sign with outstanding adhesive strength, suitable for almost all industrial floors, removable without leaving residue
MATERIAL	Plastic PVC
COLOR	Red / white / black
FASTENING	Self-adhesive surface on the backside
PACK QUANTITY	1 piece

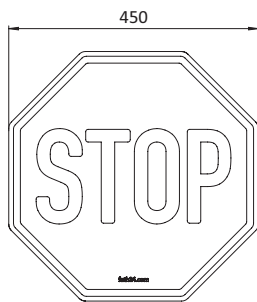

Weight [g]
184.0

Part #
0203SW01

3



CAUTION FORKLIFT ZONE FLOOR SIGN

MODEL	Warning and Notice Sign
DESCRIPTION	For fast and reliable safety marking according to ASR A1.3 / DIN EN ISO 7010, self-adhesive; Easy recognition from long distance; Forklift-resistant and slip-proof floor sign with outstanding adhesive strength, suitable for almost all industrial floors, removable without leaving residue
MATERIAL	Plastic PVC
COLOR	Yellow / black
FASTENING	Self-adhesive surface on the backside
PACK QUANTITY	1 piece

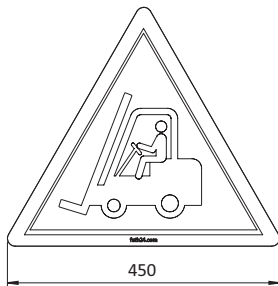

Weight [g]	Part #
104.0	0203SW02



WARNING SLIPPERY SURFACE FLOOR SIGN

MODEL	Warning and Notice Sign
DESCRIPTION	For fast and reliable safety marking according to ASR A1.3 / DIN EN ISO 7010, self-adhesive; Easy recognition from long distance; Forklift-resistant and slip-proof floor sign with outstanding adhesive strength, suitable for almost all industrial floors, removable without leaving residue
MATERIAL	Plastic PVC
COLOR	Yellow / black
FASTENING	Self-adhesive surface on the backside
PACK QUANTITY	1 piece



Weight [g]
104.0

Part #
0203SW03

3



VISUAL MANAGEMENT



Stickers

4

Stickers



No Handshake Sticker

119



No Entry Sticker

120

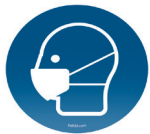

Face Mask Sticker

121



Face Protection Sticker

122



Disinfect Hands Sticker

123



Wash Hands Sticker

124



Traffic Arrow Sticker

125



Safe Distance Sticker

126



FATH

STICKERS

Visualize protection measures:
FATH information stickers for multiple surfaces



- Self-adhesive on all smooth surfaces
- 300 mm diameter for extraordinary signal effect
- Can be removed without residue from almost all surfaces
- Reusable
- Standard-compliant labelling in accordance with ASR A1.3 / DIN EN ISO 7010
- Language-independent

HIGHLIGHTS

FATH stickers allow you to clearly mark areas that are prohibited or restricted. The stickers can provide warnings or offer information identifying areas that are safe for employees, customers, and visitors.

The high-quality stickers for walls, doors, and all smooth surfaces are ready-to-use: simply peel them off the backing paper and apply them immediately. Even on rounded surfaces, such as supporting pillars in the production hall, the form-stable film allows for application without trapping air pockets.

FATH stickers can be removed in one piece without leaving any residue and without the need to use chemical cleaning agents. After removal, the stickers retain their shape. If an adjustment to the production workflow is required, you can simply peel

off the stickers and apply them again at a new location, much like you would with a sticky note. The reusability of the labeling not only saves time and costs, but it also reduces waste and thus contributes to greater sustainability.

REPOSITIONABLE



Labeling is easy to use

With **FATH** labels, you can simplify your process by eliminating the laborious process of creating, printing, laminating, and attaching labels with a separate adhesive. In line with the Lean philosophy, the form-stable stickers are easy to apply and provide visualization of the necessary instructions via standard pictograms. **FATH** stickers for safety marking according to ASR A1.3 / DIN EN ISO 7010 have a remarkably good warning and signaling effect. As they can be removed quickly without leaving a residue and they are also suitable as temporary labeling.



FATH

FATH Stickers: Pictograms for all important markings

Mandatory Stickers				
Face Mask Sticker	Face Protection Sticker	Disinfect Hands Sticker	Wash Hands Sticker	Traffic Arrow Sticker

Prohibitive Stickers	Warning and Notice Stickers	
No Handshake Sticker	No Entry Sticker	Safe Distance Sticker

Floor Signs

In addition to **FATH** stickers, **FATH** offers high-quality floor signage for almost all industrial floors. They have high adhesive strength, are forklift-resistant, and are extremely durable. The pictograms comply with ASR standards and include all important markings in the categories of prohibiting, instructing, warning, and information signage. The ideal addition for all applications where heavy-duty marking is required.



More about the **FATH** Floor Signs:
floor-sign.fath24.com

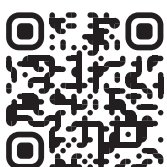

Would you like to learn more about
FATH Stickers?

stickers.fath24.com

NO HANDSHAKE STICKER

MODEL	Prohibitive Sticker
DESCRIPTION	For fast and reliable safety marking according to ASR A1.3 / DIN EN ISO 7010, self-adhesive; Easy recognition from long distance; with outstanding adhesive strength, suitable for all smooth surfaces, removable without leaving residue
MATERIAL	Plastic PVC
COLOR	Red / white / black
FASTENING	Self-adhesive surface on the backside
PACK QUANTITY	5 pieces

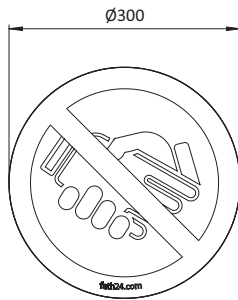

Part #
0209SP01

NO ENTRY STICKER

MODEL	Prohibitive Sticker
DESCRIPTION	For fast and reliable safety marking according to ASR A1.3 / DIN EN ISO 7010, self-adhesive; Easy recognition from long distance; with outstanding adhesive strength, suitable for all smooth surfaces, removable without leaving residue
MATERIAL	Plastic PVC
COLOR	Red / white
FASTENING	Self-adhesive surface on the backside
PACK QUANTITY	5 pieces

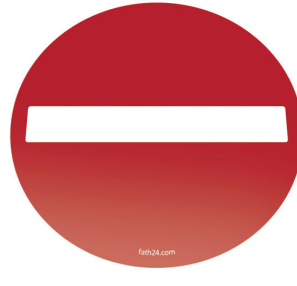
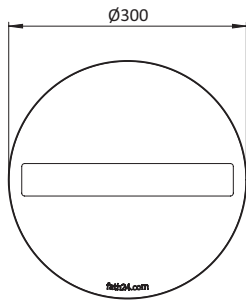

Part #
0209SP02

FACE MASK STICKER

MODEL	Mandatory Sticker
DESCRIPTION	For fast and reliable safety marking according to ASR A1.3 / DIN EN ISO 7010, self-adhesive; Easy recognition from long distance; with outstanding adhesive strength, suitable for all smooth surfaces, removable without leaving residue
MATERIAL	Plastic PVC
COLOR	Blue / white
FASTENING	Self-adhesive surface on the backside
PACK QUANTITY	5 pieces

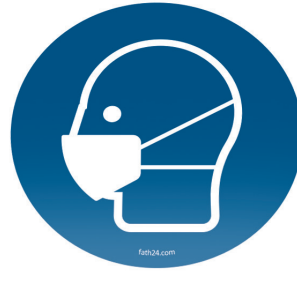
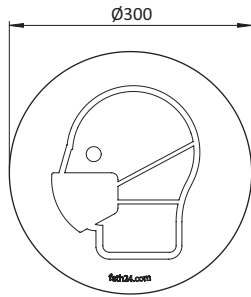

Part #
0209SM01

FACE PROTECTION STICKER

MODEL	Mandatory Sticker
DESCRIPTION	For fast and reliable safety marking according to ASR A1.3 / DIN EN ISO 7010, self-adhesive; Easy recognition from long distance; with outstanding adhesive strength, suitable for all smooth surfaces, removable without leaving residue
MATERIAL	Plastic PVC
COLOR	Blue / white
FASTENING	Self-adhesive surface on the backside
PACK QUANTITY	5 pieces

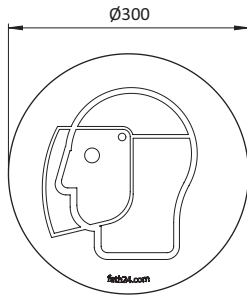

Part #
0209SM02

DISINFECT HANDS STICKER

MODEL	Mandatory Sticker
DESCRIPTION	For fast and reliable safety marking according to ASR A1.3 / DIN EN ISO 7010, self-adhesive; Easy recognition from long distance; with outstanding adhesive strength, suitable for all smooth surfaces, removable without leaving residue
MATERIAL	Plastic PVC
COLOR	Blue / white
FASTENING	Self-adhesive surface on the backside
PACK QUANTITY	5 pieces

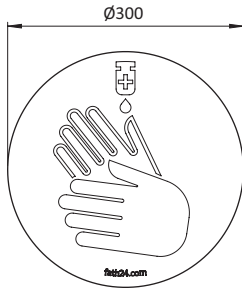

Part #
0209SM03

WASH HANDS STICKER

MODEL	Mandatory Sticker
DESCRIPTION	For fast and reliable safety marking according to ASR A1.3 / DIN EN ISO 7010, self-adhesive; Easy recognition from long distance; with outstanding adhesive strength, suitable for all smooth surfaces, removable without leaving residue
MATERIAL	Plastic PVC
COLOR	Blue / white
FASTENING	Self-adhesive surface on the backside
PACK QUANTITY	5 pieces

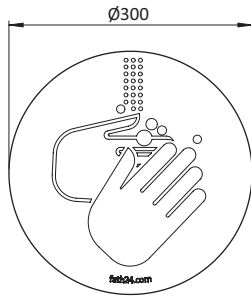

Part #

0209SM04

TRAFFIC ARROW STICKER

MODEL	Mandatory Sticker
DESCRIPTION	For fast and reliable safety marking according to ASR A1.3 / DIN EN ISO 7010, self-adhesive; Easy recognition from long distance; with outstanding adhesive strength, suitable for all smooth surfaces, removable without leaving residue
MATERIAL	Plastic PVC
COLOR	Blue / white
FASTENING	Self-adhesive surface on the backside
PACK QUANTITY	5 pieces

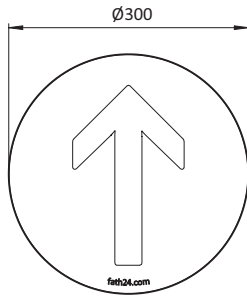

Part #
0209SM05

SAFE DISTANCE STICKER

MODEL	Warning and Notice Sticker
DESCRIPTION	For fast and reliable safety marking according to ASR A1.3 / DIN EN ISO 7010, self-adhesive; Easy recognition from long distance; with outstanding adhesive strength, suitable for all smooth surfaces, removable without leaving residue
MATERIAL	Plastic PVC
COLOR	Yellow / black
FASTENING	Self-adhesive surface on the backside
PACK QUANTITY	5 pieces

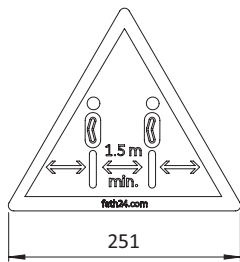

Part #

0209SW01

VISUAL MANAGEMENT



Sign Frames

5

Sign Frames

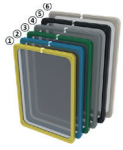

Message Frame DIN A4 - 8.3" x 11.7" (Set)

135



Message Frame DIN A3 - 11.7" x 16.5" (Set)

136



Closing Clip

137



Hanging Hook

138



Swivel Loop

139



S-hook

140



Tube Clamp

141



Swivel Magnet Holder

142



Aluminum Tube (Set)

143



Knotted Chain

144



Ceiling Magnet with Hook

145

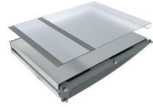

Sign Holder AL (Set)

146

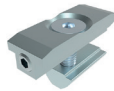

Direct Connector I, Slot 8

148



T-connector Plate D28

149



Friction Joint I40L for System Arm (Set)

150

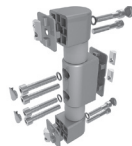

Friction Joint I80H for System Arm (Set)

151



FATH

SIGN FRAMES

Mark industrial areas quickly and clearly



- For A3 and A4 printouts
- Both sides can be used - portrait and landscape
- Wide range of mounting options
Anti-reflective film
- Easy to attach without tools
- PVC-free product

HIGHLIGHTS

With the **FATH** Message Frames, all areas in production, warehouse, and logistics can be marked easily and expediently. Due to the double-sided usability, different information can also be provided on each side.

You can print your information documents on a standard printer and immediately insert them behind the A3 / A4 format film - no cutting or alignment is necessary. Since the film is closed on one side, the printout can be securely positioned with a single hand movement and cannot slip. The film completely encloses the printout, so that the paper is well protected.

The border of the Message Frame is narrow - the entire information area of the A3 / A4 printout is visible. The flexible transparent film makes handling particularly efficient. At the same time, the frame offers

the necessary rigidity to give the signage a high level of dimensional stability and to keep the paper completely legible.

The different frame colors allow you to implement the signage according to your individual color standard.

EASY AND FLEXIBLE MOUNTING

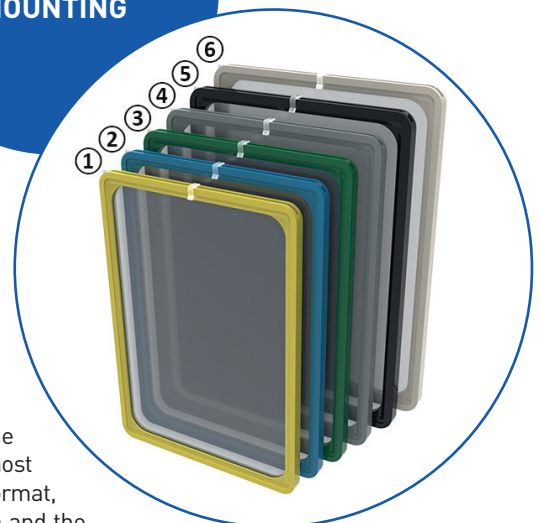

Visual management made easy

The versatile attachment options make the **FATH** placard holder a multifunctional visualization tool. Different clips are available for quick mounting. Simply clip onto the frame and hang, stick, pin or magnetically attach the signage to the shelf crossbar - with the right accessories, your signage will be affixed to almost any supporting structure and in any environment in seconds. To change the format, simply reposition the clip. The locking clip included in the set secures the film and the print against slipping, whatever the orientation.

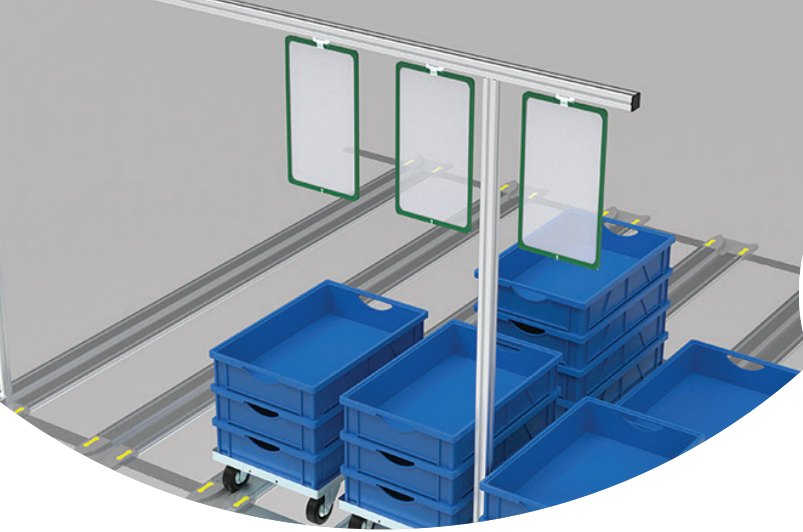

FATH

Accessories

FATH Message Frames can be used for almost any application thanks to the extensive range of signage accessories. Hanging the frame above areas, machines or bays is the simplest way to achieve visualization. The use of a knotted chain and plastic hooks allows for flexible labeling at any height. The Message Frame can be attached directly to machines or shelves using magnetic holders. Whether portrait or landscape format, FATH accessories can be attached in both orientations. The different frame colors allow assignment to your existing color coding system.



Closing Clip For closing Message Frames, prevents transparent foil from falling out

Part-Number 02042CC



Swivel Magnet Holder For hanging Message Frames; Fast and easy mounting with integrated magnet, 360° rotatable

Part-Number 02042MH



Hanging Hook For fast and easy hanging of Message Frames; Easy swap of Message Frames due to open hooks

Part-Number 02042HH



Aluminum Tube (Set) To hang up Message Frames with pipe clamps, several Message Frames can be attached next to another; Helpful visualization even in greater heights

Part-Number 02042AT



Swivel Loop For fast and easy hanging of Message Frames; Secure hanging due to closed loop, 360° rotatable

Part-Number 02042SE



Knotted Chain For durable and easy hanging of Message Frames; Easy shortening of the chain

Part-Number 02042KC



S-hook For fast and easy hanging of Message Frames

Part-Number 02042SH



Ceiling Magnet with Hook For hanging Message Frames; Fast and easy mounting with integrated magnet

Part-Number 02042CM



Tube Clamp For durable mounting of Message Frames; Easy to attach to tubes and tubular frame profiles with Ø 28 mm - 30 mm outer diameter

Part-Number 02042PC

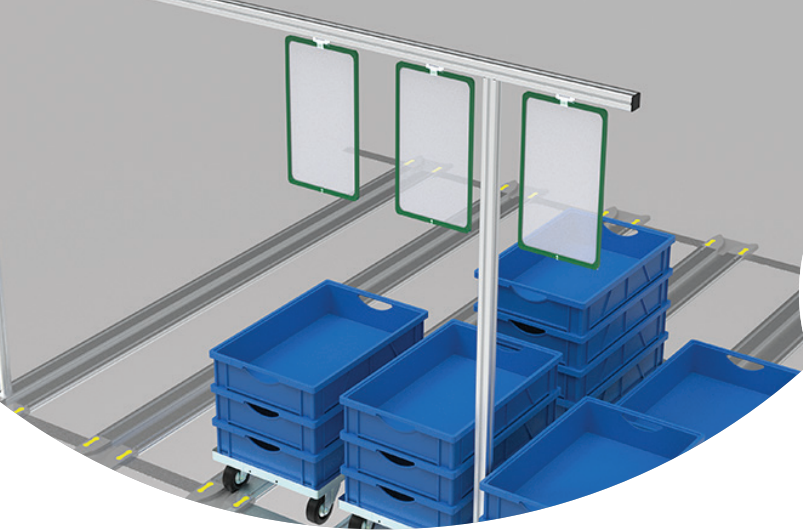

FATH

Stable and high-quality variant: FATH sign holder with aluminum body

For applications that demand high stability and a high-quality appearance, **FATH** sign holders with a solid aluminum body are the ideal solution. They can be mounted on all profile-based fixtures in a few simple steps - independent of the system and in all dimensions: from above, from below, and from the side. If necessary, eye-bolts can also be used to suspend the sign holders from the ceiling. This means that they can also be used in warehouses and logistics.

The aluminum base body gives the **FATH** sign holder sufficient weight and rigidity to remain stable and virtually free of movement in the desired position. The PVC-free, oil-resistant plastic surface is easy to wipe clean and withstands rigorous use. These outstanding product features ensure clear labeling on the shop floor under almost any condition.

This variant is also designed to allow quick change of signage at any time and to hold your printouts securely in the sign holder - without slipping or overhanging. Two cover caps for closing the sides are included.

FATH sign holders can be reused and remounted as often as necessary - a sustainable LEAN product.



Even more flexible with FATH Friction Joints

Highly flexible alignment of **FATH** sign holders is achieved through the use of **FATH** friction joints. This means that the sign holders can be turned and tilted exactly as the work process requires - without tools and with a single hand movement. Friction causes the sign holder to be held firmly in the desired position. This application is also ideal for signaling.



More about the **FATH** Friction Joints:
frictionjoint.fath24.de

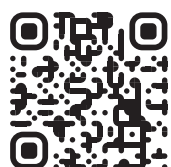
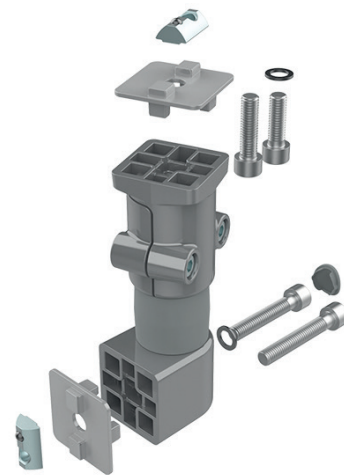

Would you like to learn more about
FATH Sign Frames?

sign-frame.fath24.com

MESSAGE FRAME DIN A4 - 8.3" X 11.7" (SET)

MODEL	DIN A4 - 8.3" x 11.7"
DESCRIPTION	For well visible labeling of shelves and storage spaces Usable from both sides due to transparent foil; Scanner friendly due to antireflective foil Diverse frame colors for individual visualization Applicable in portrait or landscape format
MATERIAL	Frame: Plastic PS Transparent foil: Plastic PET Clip: Plastic PC
COLOR	Yellow, blue, green, gray, black, white
SET	1 frame 1 transparent foil 1 clip
PACK QUANTITY	5 set
SPECIALS	Other colors on request
TIP	Compatible closing clip see 02042CC Compatible hanging hook see 02042HH Compatible swivel loop see 02042SE Compatible tube clamp see 02042PC Compatible swivel magnet holder see 02042MH

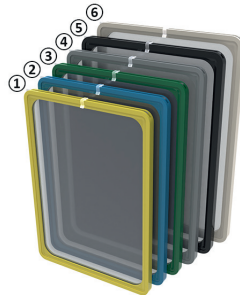
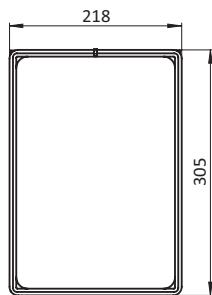

Fig.	Color	Weight [g]	Part #
①	Yellow ≈ RAL 1016	744.0	02041A415
②	Blue ≈ RAL 5015	744.0	02041A455
③	Green ≈ RAL 6029	744.0	02041A463
④	Gray ≈ RAL 7045	744.0	02041A475
⑤	Black ≈ RAL 9005	744.0	02041A491
⑥	White ≈ RAL 9001	744.0	02041A493

MESSAGE FRAME DIN A3 - 11.7" X 16.5" (SET)

MODEL	DIN A3 - 11.7" x 16.5"
DESCRIPTION	For well visible labeling of shelves and storage spaces Usable from both sides due to transparent foil; Scanner friendly due to antireflective foil Diverse frame colors for individual visualization Applicable in portrait or landscape format
MATERIAL	Frame: Plastic PS Transparent foil: Plastic PET Clip: Plastic PC
COLOR	Yellow, blue, green, gray, black, white
SET	1 frame 1 transparent foil 1 clip
PACK QUANTITY	5 set
TIP	Compatible closing clip see 02042CC Compatible hanging hook see 02042HH Compatible swivel loop see 02042SE Compatible tube clamp see 02042PC Compatible swivel magnet holder see 02042MH

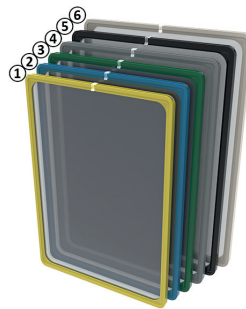
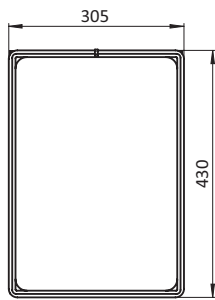
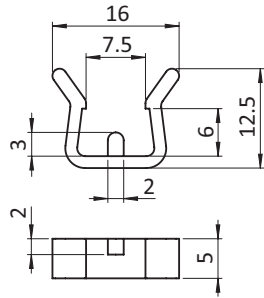

Fig.	Color	Weight [g]	Part #
①	Yellow ≈ RAL 1016	1350.0	02041A315
②	Blue ≈ RAL 5015	1350.0	02041A355
③	Green ≈ RAL 6029	1350.0	02041A363
④	Gray ≈ RAL 7045	1350.0	02041A375
⑤	Black ≈ RAL 9005	1350.0	02041A391
⑥	White ≈ RAL 9001	1350.0	02041A393

CLOSING CLIP

MODEL	For Message Frames DIN A4 - 8.3" x 11.7" and DIN A3 - 11.7" x 16.5"
DESCRIPTION	For closing Message Frames, prevents transparent foil from falling out
MATERIAL	Plastic PC
COLOR	Transparent
PACK QUANTITY	10 pieces
SPECIALS	Other colors on request
TIP	Compatible Message Frame DIN A4 - 8.3" x 11.7" see 02041A415 Compatible Message Frame DIN A3 - 11.7" x 16.5" see 02041A315



Weight [g]	Part #
0.3	02042CC

HANGING HOOK

MODEL	For Message Frames DIN A4 - 8.3" x 11.7" and DIN A3 - 11.7" x 16.5"
DESCRIPTION	Fast and easy hanging of Message Frames, Easy swap of Message Frames due to open hooks
MATERIAL	Plastic PC
COLOR	Transparent
PACK QUANTITY	10 pieces
TIP	Compatible swivel loop see 02042SE Compatible S-hook see 02042SH Compatible knotted chain see 02042KC Compatible Message Frame DIN A4 - 8.3" x 11.7" see 02041A415 Compatible Message Frame DIN A3 - 11.7" x 16.5" see 02041A315

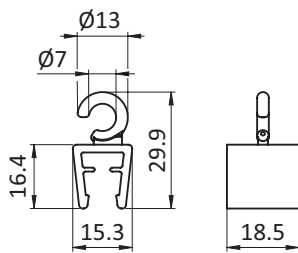

Weight [g]	Part #
2.3	02042HH

SWIVEL LOOP

MODEL	For Message Frames DIN A4 - 8.3" x 11.7" and DIN A3 - 11.7" x 16.5"
DESCRIPTION	Fast and easy hanging of Message Frames, Secure hanging due to closed loop 360° rotatable
MATERIAL	Plastic PA
COLOR	Transparent
PACK QUANTITY	10 pieces
TIP	Compatible hanging hook see 02042HH Compatible S-hook see 02042SH Compatible knotted chain see 02042KC Compatible Message Frame DIN A4 - 8.3" x 11.7" see 02041A415 Compatible Message Frame DIN A3 - 11.7" x 16.5" see 02041A315

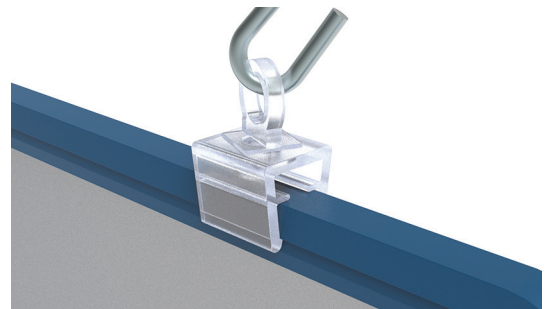
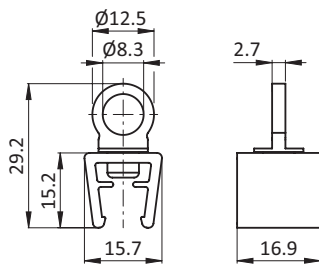

Weight [g]	Part #
2.2	02042SE

S-HOOK

MODEL	For Message Frames DIN A4 - 8.3" x 11.7" and DIN A3 - 11.7" x 16.5"
DESCRIPTION	Fast and easy hanging of Message Frames
MATERIAL	Steel
SURFACE	Zinc plated
PACK QUANTITY	10 pieces
TIP	Compatible knotted chain see 02042KC Compatible Message Frame DIN A4 - 8.3" x 11.7" see 02041A415 Compatible Message Frame DIN A3 - 11.7" x 16.5" see 02041A315

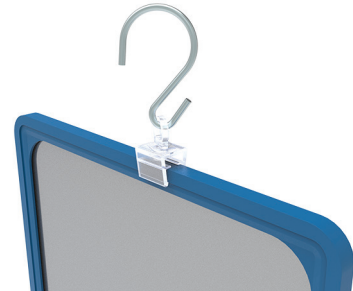
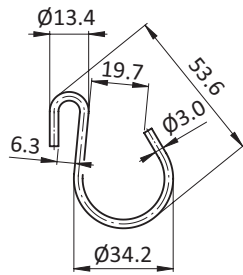

Weight [g]	Part #
6.4	02042SH

TUBE CLAMP

MODEL	For Message Frames DIN A4 - 8.3" x 11.7" and DIN A3 - 11.7" x 16.5"
DESCRIPTION	Durable mounting of Message Frames, Easy to attach to tubes and tubular frame profiles with Ø 28 mm - 30 mm outer diameter
MATERIAL	Plastic PA
COLOR	Transparent
PACK QUANTITY	10 pieces
TIP	Compatible aluminum tube (set) see 02042AT Compatible Message Frame DIN A4 - 8.3" x 11.7" see 02041A415 Compatible Message Frame DIN A3 - 11.7" x 16.5" see 02041A315

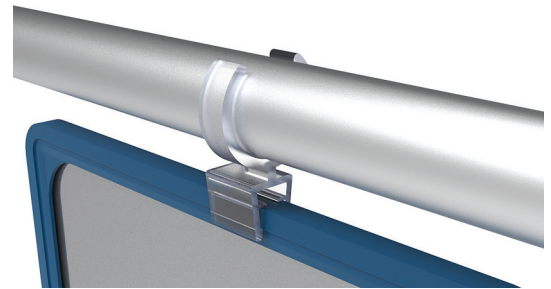
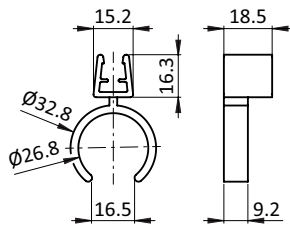

Weight [g]	Profile	Part #
4.6	Ø 28 mm - 30 mm	02042PC

SWIVEL MAGNET HOLDER

MODEL	For Message Frames DIN A4 - 8.3" x 11.7" and DIN A3 - 11.7" x 16.5"
DESCRIPTION	For hanging Message Frames Fast and easy mounting with integrated magnet 360° rotatable
MATERIAL	Plastic PA
COLOR	Transparent
PACK QUANTITY	10 pieces
TIP	Compatible Message Frame DIN A4 - 8.3" x 11.7" see 02041A415 Compatible Message Frame DIN A3 - 11.7" x 16.5" see 02041A315

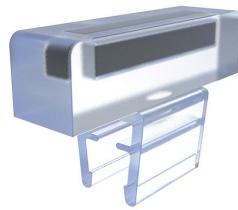
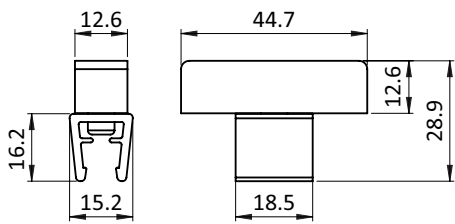

Weight [g]

20.6

Part #

02042MH

ALUMINUM TUBE (SET)

MODEL	For Message Frames DIN A4 - 8.3" x 11.7" and DIN A3 - 11.7" x 16.5"
DESCRIPTION	To hang up Message Frames with pipe clamps, several Message Frames can be attached next to another Helpful visualization even in greater heights
MATERIAL	Tube: Aluminum Cover caps: Plastic TPE
SURFACE	Tube: Anodized
COLOR	Cover caps: Gray ≈ RAL 7042
SET	1 aluminum tube 2 cover caps
PACK QUANTITY	1 set
TIP	Compatible tube clamp see 02042PC Compatible knotted chain 02042KC

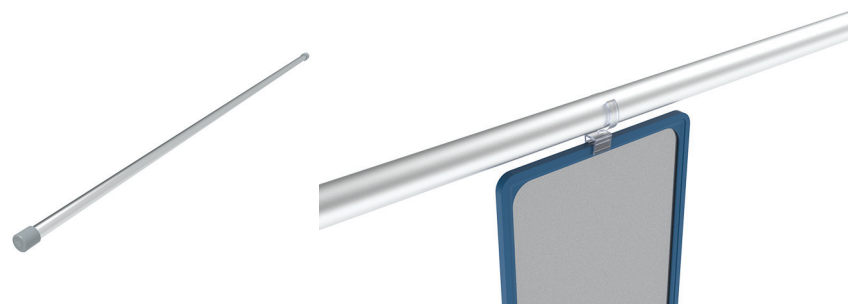
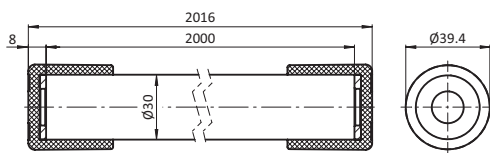

Weight [g]	Part #
495.0	02042AT

KNOTTED CHAIN

MODEL	For Message Frames DIN A4 - 8.3" x 11.7" and DIN A3 - 11.7" x 16.5"
DESCRIPTION	Durable and easy hanging of Message Frames; Easy shortening of the chain
MATERIAL	Steel
SURFACE	Zinc plated
PACK QUANTITY	30 meters (1 spool)
TIP	Compatible ceiling magnet with hook see 02042CM Compatible S-hook see 02042SH Compatible Message Frame DIN A4 - 8.3" x 11.7" see 02041A415 Compatible Message Frame DIN A3 - 11.7" x 16.5" see 02041A315

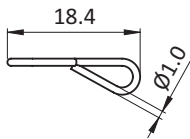

Weight [g]	Part #
776.0	02042KC

CEILING MAGNET WITH HOOK

MODEL	For Message Frames DIN A4 - 8.3" x 11.7" and DIN A3 - 11.7" x 16.5"
DESCRIPTION	For hanging Message Frames Fast and easy mounting with integrated magnet
MATERIAL	Casing: Plastic PA Magnet: Neodymium
COLOR	White
MAX. LOAD	10 kg
PACK QUANTITY	1 piece
TIP	Compatible knotted chain see 02042KC

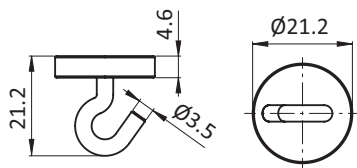

Weight [g]	Part #
13.3	02042CM

SIGN HOLDER AL (SET)

MODEL	Aluminum
DESCRIPTION	Durable mounting of signs
MATERIAL	Sign holder: Aluminum Sign foil: Plastic PET Cover Caps: Plastic PA, glass ball reinforced Screws: Steel
SURFACE	Sign holder: Anodized Screws: Zinc plated
COLOR	Cover Caps: Gray
SET	1 Sign Holder 1 Sign foil 2 Cover Caps 8 Screws 3.9 x 16
PACK QUANTITY	1 set
TIP	Compatible direct connector I, slot 8 see 099DC084040N08 Compatible T-connector plate see 093VAD28V Compatible friction joints I40H see 061FGZ40LN08 Compatible friction joints I80H see 061FGZ80HN08

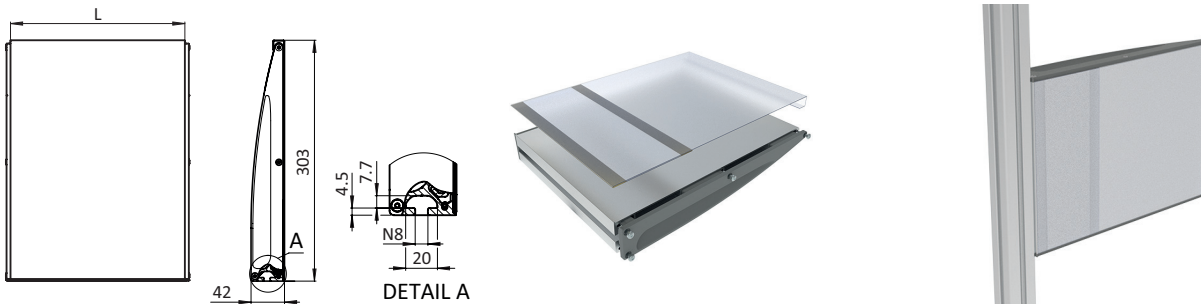

	Version	L [mm]	Slot	Size	Weight [g]	Profile	Part #
	Sign Holder AL DIN A4 - 8.3" x 11.7"	220	8	DIN A4	914.55	I	
	Sign Holder AL DIN A3 - 11.7" x 16.5"	430	8	DIN A3	1786.81	I	02064A3N0874
	Sign Holder AL 297 x 1000 - 11.7" x 39.4"	990	8	Oversize	4114.48	I	02064OSN0874



SIGN HOLDER AL (SET)

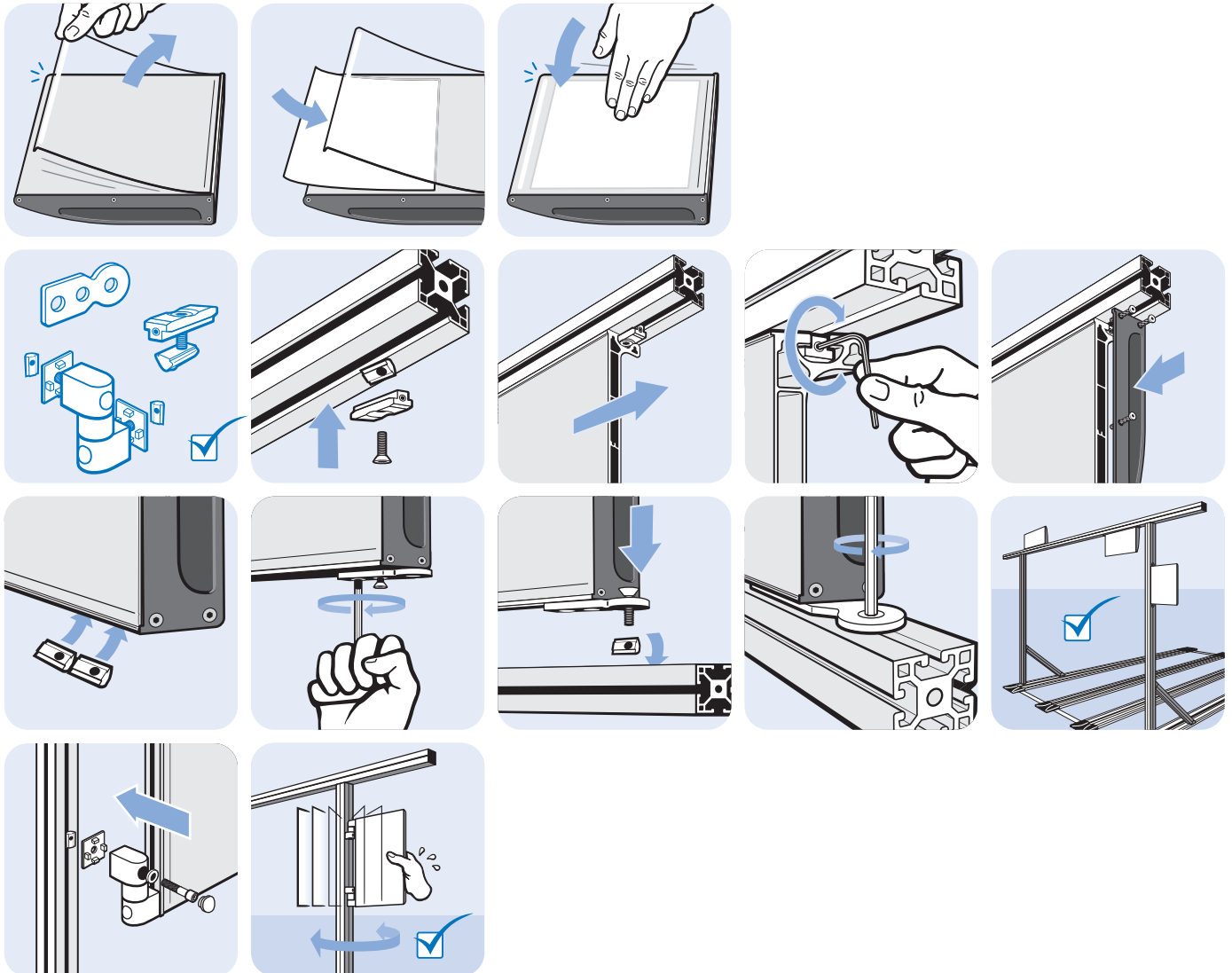

DIRECT CONNECTOR I, SLOT 8

MODEL	Steel
DESCRIPTION	To cross or parallelly connect two aluminum profiles; assembly without machining
MATERIAL	Steel
SURFACE	Zinc plated
MAX. WEIGHT DOOR	Load recommendation for each mounting point with even load spreading: $F_{max} = 400\text{ N}$
PACK QUANTITY	10 pieces

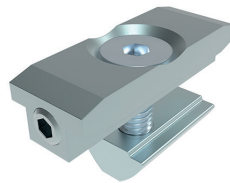
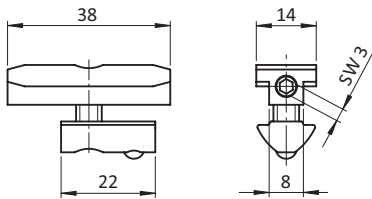

N [mm]	Weight [g]	Profile	Part #
8	38.3	I	099DC084040N08

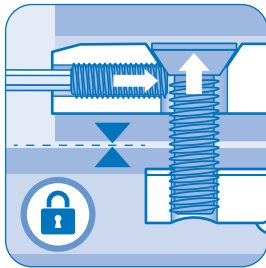
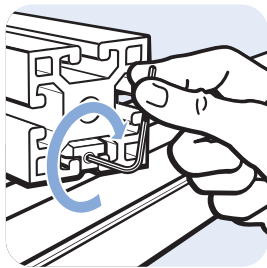
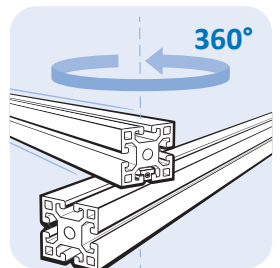
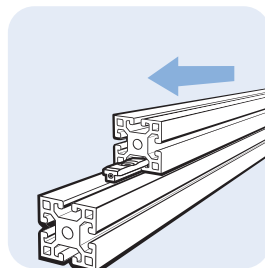
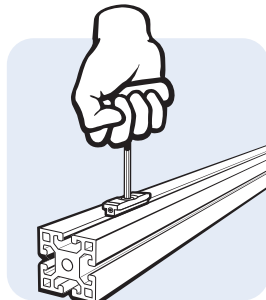
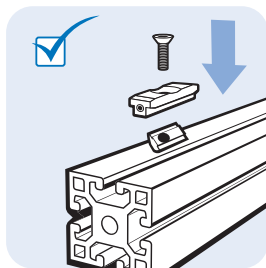
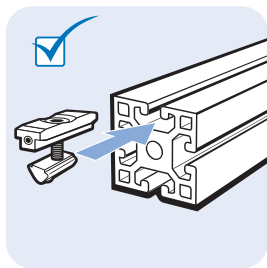

T-CONNECTOR PLATE D28

MODEL	For tubular frame profiles
DESCRIPTION	To connect a tubular frame profile with \varnothing 28 mm outer diameter with an aluminum profile at right angles; screw connection to the core hole of the \varnothing 28 mm profile or to the threaded sleeve for D28 M8 for \varnothing 28 mm tubular profiles
MATERIAL	Steel
SURFACE	Zinc plated
FASTENING	With countersunk screws 1x M8 and 2x M6
PACK QUANTITY	10 pieces
TIP	Compatible threaded sleeve D28 M8 see 099RV28AS02

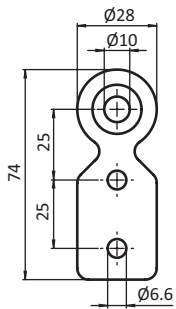

Weight [g]

Part #

52.3

093VAD28V

FRICTION JOINT I40L FOR SYSTEM ARM (SET)

MODEL	40 mm Modular Dimension
DESCRIPTION	Connection joint with friction for the creation of system arms using profile pieces; pivotable 360°; friction joint can be attached lateral, transverse, or on the face of the profile; if attached on the front face, the core hole of the respective profile must be M8 threaded (min. 15 mm deep)
MATERIAL	Housing: Aluminum die-cast Cover ring: Plastic Inserts: Steel Friction shaft: Steel Cover caps: Plastic Screws: Steel Washers: Steel Centering plates: Aluminum die-cast T-slot nuts: Steel
SURFACE	Housing: Laquered Centering plates: Laquered Screws: Zinc plated Washers: Zinc plated T-slot nuts: Zinc plated
COLOR	Housing: Alu color Cover ring: Gray ≈ RAL 7042 Cover caps: Gray ≈ RAL 7042 Centering plates: Alu color
SET	1 friction joint 2 cover caps 2 screws DIN 912 - M8 x 45 (for T-slot nut) 2 screws DIN 912 - M8 x 50 (for core hole) 2 washers 8-FSt 2 centering plates 2 T-slot nuts - slot 8 - M8
PACK QUANTITY	1 set

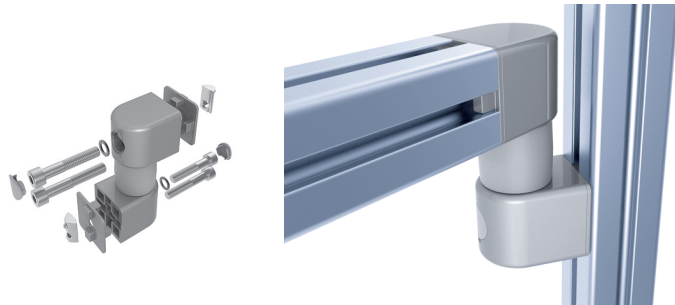
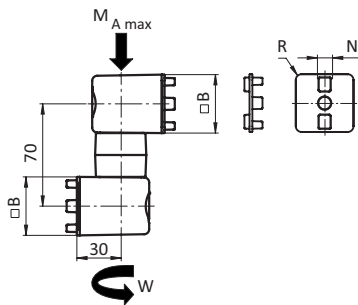

	W [Nm]	$M_{A_{max}}$ [Nm]	B [mm]	R [mm]	Slot	Weight [g]	Profile	Part #
	0.5	45.0	40	4.0	8	782.0	I	061FGZ40LN08
	3	45.0	40	4.0	8	783.0	I	061FGN40LN08
	6	45.0	40	4.0	8	785.0	I	061FGS40LN08
	9	45.0	40	4.0	8	786.0	I	061FGM40LN08
	12	45.0	40	4.0	8	787.0	I	061FGB40LN08
	15	45.0	40	4.0	8	789.0	I	061FGL40LN08

FRICTION JOINT I80H FOR SYSTEM ARM (SET)

MODEL	40 mm Modular Dimension
DESCRIPTION	Connection joint with friction for the creation of system arms using profile pieces; pivotable 360°; friction joint can be attached lateral, transverse, or on the face of the profile; if attached on the front face, the core hole of the respective profile must be M8 threaded (min. 15 mm deep)
MATERIAL	Housing: Aluminum die-cast Cover ring: Plastic Inserts: Steel Friction shaft: Steel Cover caps: Plastic Screws: Steel Washers: Steel Centering plates: Aluminum die-cast T-slot nuts: Steel
SURFACE	Housing: Laquered Centering plates: Laquered Screws: Zinc plated Washers: Zinc plated T-slot nuts: Zinc plated
COLOR	Housing: Alu color Cover ring: Gray ≈ RAL 7042 Cover caps: Gray ≈ RAL 7042 Centering plates: Alu color
SET	1 friction joint 4 cover caps 4 screws DIN 912 - M8 x 45 (for T-slot nut) 4 screws DIN 912 - M8 x 50 (for core hole) 4 washers 8-FSt 4 centering plates 4 T-slot nuts - slot 8 - M8
PACK QUANTITY	1 set

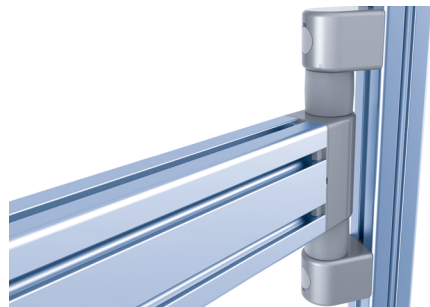
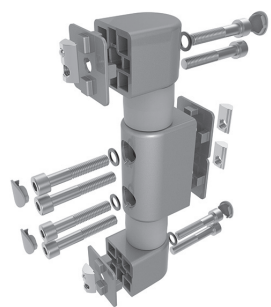
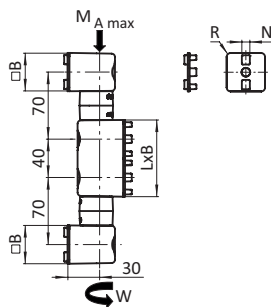

	W [Nm]	MA _{max} [Nm]	R [mm]	Slot	L x B [mm]	Weight [g]	Profile	Part #
	2x 0.5	200.0	4.0	8	80 x 40	1575.0	I	061FGZ80HN08
	2x 3	200.0	4.0	8	80 x 40	1581.0	I	061FGN80HN08
	2x 6	200.0	4.0	8	80 x 40	1584.0	I	061FGS80HN08
	2x 9	200.0	4.0	8	80 x 40	1587.0	I	061FGM80HN08
	2x 12	200.0	4.0	8	80 x 40	1578.0	I	061FGB80HN08
	2x 15	200.0	4.0	8	80 x 40	1590.0	I	061FGL80HN08

VISUAL MANAGEMENT



Inserting Systems

6

Inserting Systems



Inserting Box DIN A5 Landscape - 8.3" x 5.8" **157**



Inserting Box 1/3 DIN A4 Portrait - 8.3" x 3.9" **158**



Inserting Box DIN A4 Portrait - 8.3" x 11.7" **159**



Window for Inserting Boxes **160**



KANBAN Wall Bracket for Inserting Boxes **161**



Wall File Pocket **162**



Magnet for Inserting Systems (Set) **163**

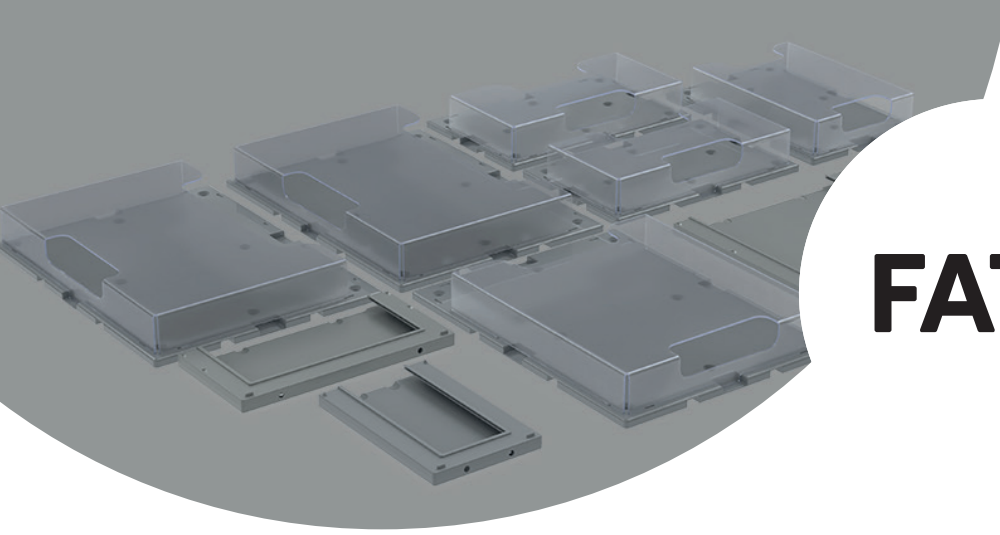

FATH

INSERTING SYSTEMS

Efficiently structure production processes and the flow of goods and information with FATH Inserting Systems



- Document holders for sizes DIN A4, DIN A5 and 1/3 DIN A4
- Wall mounting, e.g., for Kanban boards
- Break-proof document holder for single use, e.g., as a mailbox
- Simple and clear provision of information throughout the entire shopfloor

HIGHLIGHTS

FATH Inserting Systems for document sizes DIN A4, DIN A5 and 1/3 DIN A4 are a simple tool for implementing the Kanban principle in line with lean production. This creates an efficient organizational structure that ensures oversight in daily production operations. The inserting system boxes ensure a seamless process in the provision of information and materials. The desired sequence for order processing can be controlled by using the inserted cards.

Single compartment, Kanban box or Kanban board: In day-to-day operations, the inserting system boxes provide quick access to the relevant information and allow processes to be put in the right order.

Practical wall mounting for clear structure and quick oversight: Sturdy metal wall brackets for screwing onto profiles, walls or machines are available as accessories for all **FATH** inserting system boxes. This means you can implement your individual inserting system and quickly and easily adapt it to changing requirements at any time.

**MORE EFFICIENT
FLOW OF GOODS &
INFORMATION**



Inserting system boxes for walls and Kanban boards

Boxes for A4 documents hold construction drawings, shipping documents, etc. If the A4 documents are folded, A5 inserting system boxes can be used and the space requirement will be significantly smaller. When placed one below the other, the individual inserting system boxes create a column that can be used as a Kanban board.

The boxes show which activity is to be processed next or what should be produced in the next step. A system as simple as it is efficient.

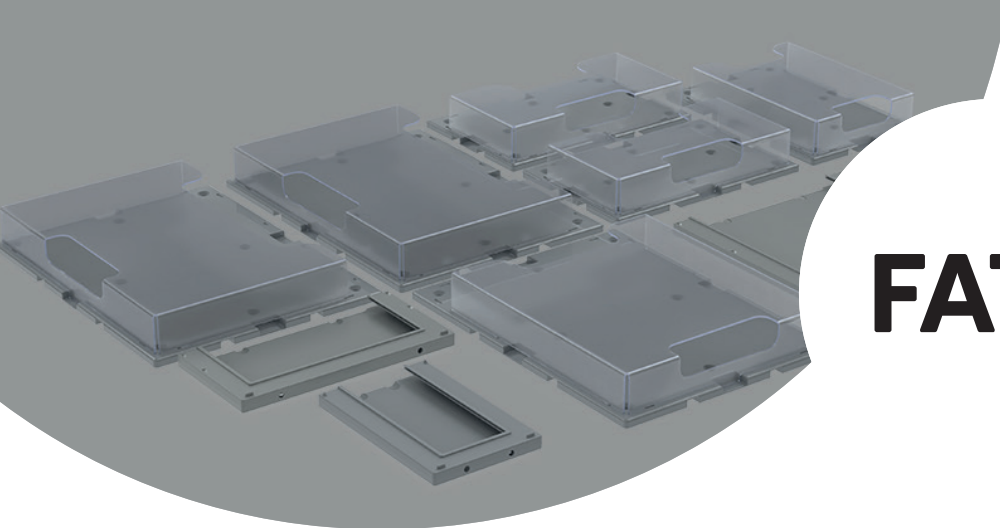

FATH

Kanban board: FATH inserting system for Kanban cards

The 1/3 DIN A4 boxes are specially designed for Kanban cards in accordance with the VDA standard. When the material is used up, the Kanban card is removed from the Kanban container and inserted into the corresponding box on the Kanban board. This signals the need for replenishment and the production can be continued without lead times being affected. That's lean!

FATH Document Holders: comprehensive information under control

FATH screw-on document holders made of break-proof plastic can serve as a single compartment for a stack of documents or for files of all kinds, such as orders with multi-page drawings and test reports, or as a collection box for Kanban cards. There is also room in the holders for thicker document stacks and process folders. In the logistics and production process, they provide a quick overview and full transparency in another respect: **FATH** Document Holders are themselves transparent.

FATH Document Holders have two parts. The solid plastic mounting plate is screwed to the wall, the machine or the profile. The transparent front part can easily be snapped into place on this sturdy bracket. The front of the inserting system box is cut out for quick access to smaller documents. The document holders are made of extremely shatterproof special plastic and can be used in any production environment.

Accessories:

FATH inserting systems can be adapted even better to your needs with the following accessories:

- Kanban wall holder
- magnets (set)

Versions:



FATH Inserting Systems are available in the following versions:

Systems / document size

Inserting system boxes for column formation

- DIN A4 portrait
- DIN A5 landscape
- 1/3 DIN A4 portrait / VDA standard

with additional viewing windows in

- 1/3 DIN A4 landscape, small & portrait, large
- DIN A4 landscape, small & portrait, large
- DIN A5 landscape, small & portrait, large



Document holder as single compartment

- DIN A4 portrait & landscape
- DIN A5 portrait & landscape



Would you like to learn more about **FATH** Inserting Systems?

inserting-system.fath24.com

INSERTING BOX DIN A5 LANDSCAPE - 8.3" X 5.8"

MODEL	For wall attachment
DESCRIPTION	For holding KANBAN cards, column formation through special design possible, modular construction
MATERIAL	Plastic ABS
COLOR	Gray
PACK QUANTITY	10 pieces
TIP	Compatible magnet see 02021N45G, Compatible window see 02052E03A4P Compatible labels on request

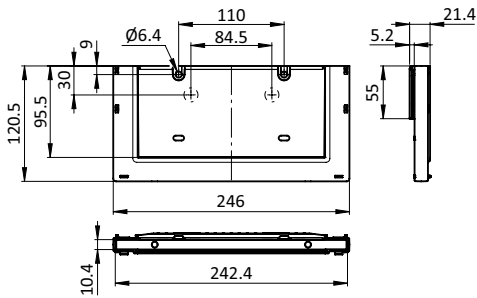

Weight [g]

Part #

108.0

02052A5L75

INSERTING BOX 1/3 DIN A4 PORTRAIT - 8.3" X 3.9"

MODEL	For wall attachment
DESCRIPTION	For holding KANBAN cards, column formation through special design possible, modular construction
MATERIAL	Plastic ABS
COLOR	Gray
PACK QUANTITY	50 pieces
TIP	Compatible magnet see 02021N45G, Compatible window see 02052E03A4P Compatible labels on request

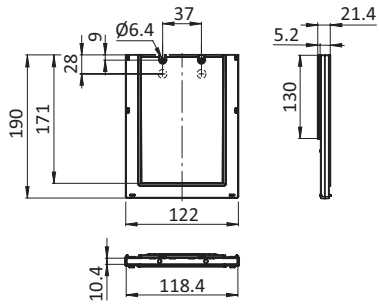

Weight [g]

Part #

99.0

02052A1/375

INSERTING BOX DIN A4 PORTRAIT - 8.3" X 11.7"

MODEL	For wall attachment
DESCRIPTION	For holding KANBAN cards, column formation through special design possible, modular construction
MATERIAL	Plastic ABS
COLOR	Gray
PACK QUANTITY	10 pieces
TIP	Compatible magnet see 02021N45G, Compatible window see 02052E03A4P Compatible labels on request

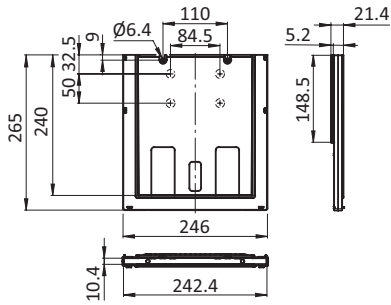

Weight [g]

Part #

221.0

02052A4P75

WINDOW FOR INSERTING BOXES

MODEL	For inserting boxes
DESCRIPTION	See through insert to protect cardboard inlays of inserting boxes
MATERIAL	Plastic PET
PACK QUANTITY	10 pieces

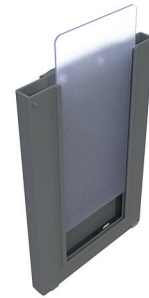
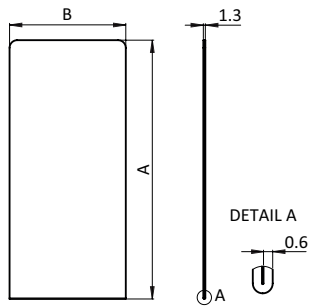

	Version	Weight [g]	Part #
	1/3 DIN A4 - 8.3" x 3.9" - Landscape, small	5.0	02052E03A1-301
	1/3 DIN A4 - 8.3" x 3.9" - Portrait, large	22.0	02052E04A1-301
	DIN A4 - 8.3" x 11.7" - Landscape, small	31.0	02052E03A4P
	DIN A4 - 8.3" x 11.7" - Portrait, large	83.0	02052E04A4P
	DIN A5 - 8.3" x 5.8" - Landscape, small	14.0	02052E03A5L
	DIN A5 - 8.3" x 5.8" - Portrait, large	34.0	02052E04A5L

KANBAN WALL BRACKET FOR INSERTING BOXES

MODEL	For inserting boxes
DESCRIPTION	Screw-on wall bracket for mounting inserting boxes on walls or whiteboards
MATERIAL	Steel
PACK QUANTITY	1 piece
TIP	Compatible magnet (set) for KANBAN wall bracket DIN A5 / A4 see 02021N35G Compatible magnet (set) for KANBAN wall bracket 1/3 DIN A4 see 02021N75G Compatible magnet (set) for KANBAN Wall Bracket Support Angle see 02021N45G

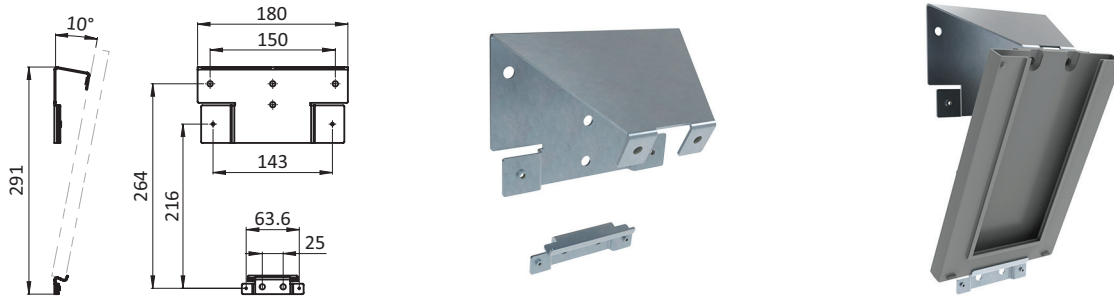

	Version	Weight [g]	Part #
	KANBAN Wall Bracket for Inserting Box DIN A5 / A4	275.0	02052E02A4A5PR01
	KANBAN Wall Bracket for Inserting Box 1/3 DIN A4	205.0	02052E02A1-3R01
	KANBAN Wall Bracket Support Angle for Inserting Boxes	26.5	02052E02AR02

WALL FILE POCKET

MODEL	For wall attachment
DESCRIPTION	For organizing documents on the shopfloor High capacity, shatter-proof, dirt-resistant
MATERIAL	Mounting Plate: Plastic ABS Wall File Pocket Component Clear: Plastic PC
COLOR	Mounting Plate: Gray Wall File Pocket Component Clear: Transparent
SET 1	1 Mounting Plate A5 Portrait 8.3" x 5.8" 1 Wall File Pocket Component Clear A5 Portrait 8.3" x 5.8"
SET 2	1 Mounting Plate A5 Landscape 8.3" x 5.8" 1 Wall File Pocket Component Clear A5 Landscape 8.3" x 5.8"
SET 3	1 Mounting Plate A4 Portrait 8.3" x 11.7" 1 Wall File Pocket Component Clear A4 Portrait 8.3" x 11.7"
SET 4	1 Mounting Plate A4 Landscape 8.3" x 11.7" 1 Wall File Pocket Component Clear A4 Landscape 8.3" x 11.7"
PACK QUANTITY	1 set
TIP	Compatible magnet see 02021N45G

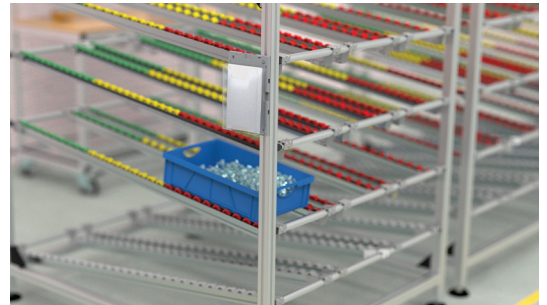
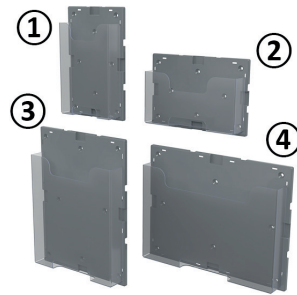
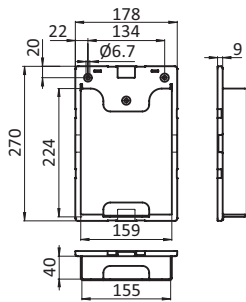

Fig.	Set	Version	Weight [g]	Part #
①	Set 1	DIN A5 - 8.3" x 5.8" - Portrait	270.0	02051A5PS01
②	Set 2	DIN A5 - 8.3" x 5.8" - Landscape	260.0	02051A5LS01
③	Set 3	DIN A4 - 8.3" x 11.7" - Portrait	500.0	02051A4PS01
④	Set 4	DIN A4 - 8.3" x 11.7" - Landscape	500.0	02051A4LS01

MAGNET FOR INSERTING SYSTEMS (SET)

MODEL	Pre-assembled
DESCRIPTION	To attach inserting boxes or wall file pockets to magnetic surfaces
MATERIAL	Magnets: Neodymium
SET 1	2 magnets Ø 15 mm 2 plastic direct screws 2 x 4
SET 2	2 magnets Ø 22 mm 2 screws M2.5
SET 3	2 magnet Ø 42 mm 2 screws M4
PACK QUANTITY	1 set

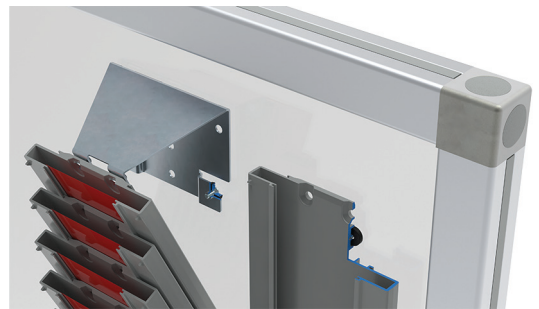
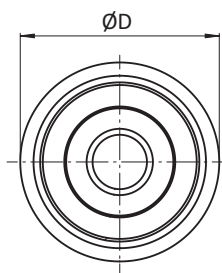

Fig.	Set	Version	ØD [mm]	Weight [g]	Part #
①	Set 1	Inserting Boxes / Wall File Pocket / Organizer UTENSILO	15	1.600	02021N45G
②	Set 2	KANBAN Wall Bracket Support Angle for Inserting Boxes	22	2.600	02021N35G
③	Set 3	KANBAN Wall Bracket for Inserting Boxes	42	4.500	02021N75G







VISUAL MANAGEMENT



Visual Boards

7

Visual Boards

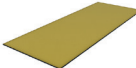
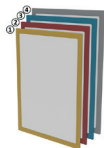
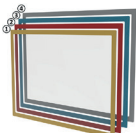
	Wall-mounted Enamel Board	171
	Mobile Enamel Board	172
	Mobile Whiteboard	173
	Mobile Enamel Cube	174
	Organizer UTENSILO, Magnetic (Set)	177
	Board Marker with Felt Eraser (Set)	178
	Cleaning Spray for Board Marker	179
	Refill Felt Pad for Eraser, Self-adhesive	180
	Magnetic Document Window DIN A4 - 8.3" x 11.7"	183
	Magnetic Document Window DIN A3 - 11.7" x 16.5"	184



Monitor Support 4-axis, Height Adjustable (Set) **185**



Monitor Support 5-axis, Height Adjustable (Set) **186**



Monitor Suspension Arm SKY 600,
Height Adjustable with Locking (Set) **188**



Monitor Work Station SIT / STAND 4-axis,
Profile Attachment (Set) **189**



Keyboard Holder AL, Slot 8 (Set) **191**

FATH

VISUAL BOARDS

**Key figures clearly and flexibly:
All important information at a glance with FATH Visual Boards**



- Scratch-resistant enamel surface
- Permanent protection against marker residue
- Magnetic over the entire surface
- Different designs: enamel wall board, mobile enamel board, mobile enamel cube
- Space-saving and practical designs
- Enamel panels for customized designs sold separately

HIGHLIGHTS

The surfaces of all **FATH** Visual Boards are made of enamel – top of the line! A glass-like mixture is applied to the metal surface at temperatures of around 1000 degrees Celsius and then hardened. The result is a surface with special properties. The whiteboard surface is extremely easy to clean by simply wiping it dry. While conventional whiteboards with lacquered surfaces still leave residues from writing after wiping them down, **FATH** Visual Boards can be cleaned without leaving any residue.

The enameled surfaces are scratch-resistant, extremely resilient and retain their smooth feel over the long term. They remain undamaged even after daily use and repeated writing and wiping. In addition to writing, the entire metal surface can be used with magnets, thus turning the whiteboard into a magnetic board.

The enameled Visual Board panels are also available separately upon customer request. You can build your own whiteboard or magnetic board with custom-fit dimensions. The whiteboard panels are easily framed in your own profile. In addition to wall mounting, specific needs, such as attachment to machines, can also be met.

**ENAMELED
SURFACE & RESI-
DUE-FREE
CLEANING**



Three designs for every application and requirement

Each **FATH** Visual Board design features a metallic whiteboard surface framed in an aluminum 40 x 40 mm profile. Attachments such as monitor supports, keyboard holders, scanner holders, trays or header profiles can be easily integrated. Enamel wall boards can be securely attached to walls and are also suitable for mounting on machine enclosures or shelving systems. Mobile enamel boards are available in a single-sided version as well as a double-sided version with an enamel surface on the front and back.



FATH

Enamel wallboard: easy to attach to aluminum profiles

This design is suitable for mounting on walls as well as attaching on machine enclosures or protective fences. Mounting on aluminum profiles can be completed in a few easy steps using the whiteboard's 40x40 profile frame. Monitors or warning signal lamps can be attached to the profile exterior. The visible side of the profile is closed.

Mobile enamel boards: information flexibly delivered

Mobile enamel boards can be placed anywhere in the room and easily moved around at any time using the framed stand on rollers. The integrated brakes ensure that the boards are held securely in position. This design is ideal when machines are too small to attach wallboards. The mobile enamel boards are also an ideal choice for office areas or supervisor's offices, as their height will fit through any standard door. The structure is the same as that of **FATH** enamel wallboards. Industrial rollers with brakes are available as an option in the ESD version.

A special added extra: The feet on the visual boards are rubberized on their exterior. The rubber buffer above the rollers protects against injury and damage to walls and doors.

Mobile enamel cube: space-saving miracle on rollers

Thanks to its four enameled sides, the cube-shaped **FATH** Visual Board provides an incredible amount of space on a small footprint. About one square meter of floor space is required to provide as much information as on a whiteboard almost three meters wide. Since the mobile enamel cube fits through any standard door, it can be placed in any space, from meeting rooms to production and warehouse areas. The space-saving, square design is especially suitable for transportable provision of detailed information and production notices. The metallic surfaces on the mobile enamel cube are also framed in 40x40 aluminum profiles. The visible sides of the profile are enclosed to protect against contamination and deposits.

Industrial rollers with brakes are optionally available in an ESD version.







FATH

Accessories for optimal use

With these accessories, you can make optimum use of the **FATH** Visual Board – lean and sustainably. The individual items can be re-ordered via the QR code stuck on them.



Board Marker with Felt Eraser (Set)
black, red, blue, green



Cleaning Spray for Board Marker



Refill Felt Pad for Eraser
self-adhesive

Smart accessories

The **FATH** UTENSILO is the perfect addition to your **FATH** Visual Board. Board markers, cleaning agent and board erasers are neatly stored and are always handy where you need them. A marker is easily removed by twisting, while the cap remains in the UTENSILO and cannot get lost. Thanks to the magnets attached on the back, the UTENSILO sits securely on any magnetically adhesive, smooth surface. Left-handed users can adjust it to their needs by turning it 180°.



More on the **FATH** UTENSILO:
utensilo.fath24.com



Would you like to learn more about **FATH** Visual Boards?

visual-board.fath24.com

WALL-MOUNTED ENAMEL BOARD

MODEL	For wall mounting
DESCRIPTION	Flexible applicable board with one-sided enamel coating for writing on, dry wipeable, magnetic; Resistant enamelled surface, durable against mechanical and chemical influences; Profile frame 40 x 40 mm, without slot on the front side, circumferential slot 8 on the side for mounting accessories like monitor or keyboard holders; Supplied with wall spacers for easier mounting
MATERIAL	Board: MDF, steel Profile frame: Aluminum Spacer: Plastic PA
SURFACE	Board: Enamelled Profile frame: Anodized
COLOR	Board: White Spacer: Black
SET	1 wall-mounted enamel board 4 spacers
FASTENING	From the back, using M8 screws
PACK QUANTITY	1 piece

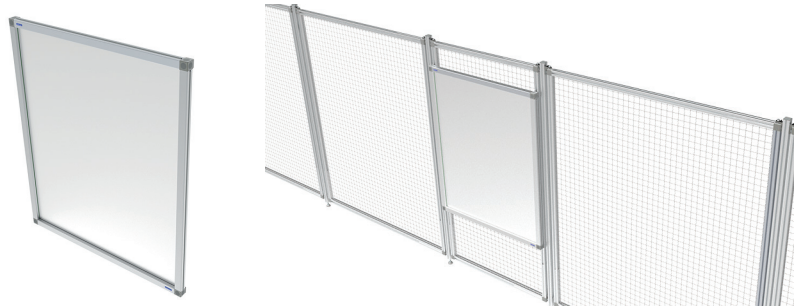
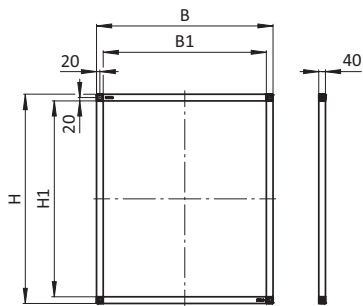

B [mm]	H [mm]	B1 [mm]	H1 [mm]	Profile	Weight [kg]	Part #
1057.0	1253.0	977.0	1173.0	I	9.3	020611000
2059.0	1253.0	1979.0	1173.0	I	14.8	020612000

MOBILE ENAMEL BOARD

MODEL	One sided enamel coating
DESCRIPTION	Flexible applicable board with one-sided enamel coating for writing on, dry wipeable, magnetic on both sides, resistant enamelled surface, durable to mechanical and chemical influences; Equipped with four swivel casters for moving, two of them incl. system brakes for securing against unintended movement; Profile frame 40 x 40 mm, without slot on the front side, circumferential slot 8 on the side for mounting accessories like monitor or keyboard holders
MATERIAL	Board: MDF, steel Profile frame: Aluminum Wheel body: Plastic PP Tread: Plastic TPE
SURFACE	Board: Enamelled Profile: Anodized
COLOR	Board: White Wheel body: Gray ≈ RAL 7001 Tread: Gray ≈ RAL 7031
PACK QUANTITY	1 piece
SPECIALS	Swivel casters as ESD electrostatically discharging version on request



B [mm]	H [mm]	B1 [mm]	H1 [mm]	Profile	Weight [kg]	Part #
1057.0	1977.0	977.0	1173.0	I	21.0	020631000M
2059.0	1977.0	1979.0	1173.0	I	26.5	020632000M

MOBILE WHITEBOARD

MODEL	Double sided laquered
DESCRIPTION	Flexible applicable board with double sided laquered steel for writing on, dry wipeable, magnetic on both sides; Equipped with four swivel casters for moving, two of them incl. brakes for securing against unintended movement
MATERIAL	Board: Steel Frame: Aluminum Swivel caster arm: Steel Wheels: Plastic PA
SURFACE	Board: Laquered Frame: Laquered Swivel caster arm: Laquered
COLOR	Board: White Frame: Black Swivel caster arm: Black Wheels: Black
SET	1 board 3 frame struts 8 screws M5 x 30 2 screws M8 x 40 2 swivel casters 2 swivel casters with brake
PACK QUANTITY	1 piece
TIP	Whiteboard is not pre-assembled



B [mm]	H [mm]	B1 [mm]	H1 [mm]	Weight [kg]	Part #
1588.0	2000.0	1500.0	1200.0	30.5	02063L1500M

MOBILE ENAMEL CUBE

MODEL	Rotatable
DESCRIPTION	Flexible applicable cube, four-sided enamel coating for writing on, dry wipeable, magnetic, resistant enamelled surface, durable to mechanical and chemical influences; space saving due to square base; Equipped with four swivel casters for moving, two of them incl. system brakes for securing against unintended movement; Profile frame 40 x 40 mm, without slot on the front side, entirely preassembled
MATERIAL	Boards: MDF, steel Profile frame: Aluminum Wheel body: Plastic PP Tread: Plastic TPE
SURFACE	Boards: Enamelled Profile frame: Anodized
COLOR	Boards: White Wheel body: Gray ≈ RAL 7001 Tread: Gray ≈ RAL 7031
PACK QUANTITY	1 piece
SPECIALS	Swivel casters as ESD electrostatically discharging version on request

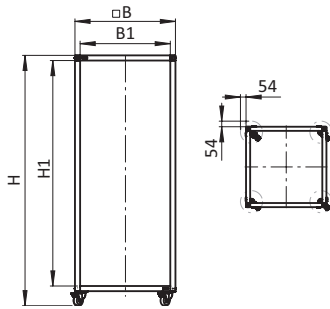

B [mm]	H [mm]	B1 [mm]	H1 [mm]	Profile	Weight [kg]	Part #
780.0	1943.0	700.0	1750.0	I	35.0	02062780



FATH

UTENSILO

Order and ergonomics:

The FATH UTENSILO keeps markers, caps and erasers neatly tucked away and within easy reach



- For all magnetic whiteboards
- Fixed slots for four markers
- Marker caps stowed tightly
- For right-handed and left-handed users
- Dry erasing with highly absorbent erasing felt
- Self-adhesive erasing felts for quick and easy replacement

HIGHLIGHTS

The **FATH** UTENSILO is the clever storage solution for all the tools you need to work effectively on a whiteboard. Board markers, caps, cleaning agent and erasers are neatly stored and are always handy where you need them. The rear-mounted magnets make it easy to attach the UTENSILO to any magnetic whiteboard. This practical aid will also sit securely on machines or other magnetic surfaces.

Both right-handed and left-handed users can intuitively manage the UTENSILO. Simply turn the top part 180°, reposition the holder for the pump bottle – and you're ready with the version that is optimally adapted to the needs of left-handed users.

The **FATH** UTENSILO comes with four board markers (in black, blue, red and green), an erasing felt and a pump bottle with cleaning

liquid. As needed, erasing felts can be re-ordered in a package of 20.

You can equip the board markers with felt if you wish. This makes it easy to make small quick corrections effortlessly while writing by turning the marker over.

The **FATH** UTENSILO comes in neutral gray, similar to RAL 7042.

FOR LEFT- AND RIGHT-HANDED USERS

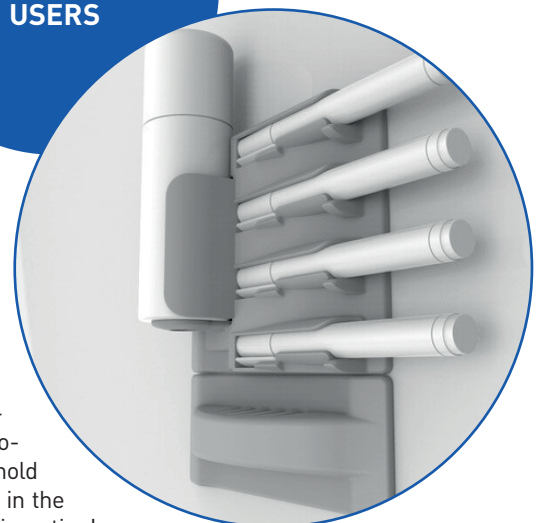

Clever holder:

Markers remain handy – caps safely stowed away

The UTENSILO has four marker slots. What's so special: The holders are designed so that a marker can be removed with one hand by a slight twisting movement. The rotation locks the cap in the holder and keeps it safely in place. You hold only the marker and close it again after use by simply inserting and turning it in the UTENSILO. No searching for the cap, no drying out of the marker, no accidental insertion! To remove the marker completely, simply turn it a little further and pull out the marker including the cap.



FATH

Accessories – lean and sustainable

With these accessories, you can restock the **FATH UTENSILIO** over and over again – lean and sustainably:

- Whiteboard markers, set of 4, black
- Whiteboard marker, set of 4, colored (blue, red, yellow, green)
- Cleaning felts
- Cleaning agent



Sophisticated board eraser for dry and wet cleaning

The flat, ergonomically shaped board eraser fits comfortably in your hand. To clean the whiteboard, simply apply an erasing cloth with a high absorption capacity by pressing it onto the sponge element. Thanks to the adhesive layer on the back, it adheres without slipping and can be removed without residues after use. The fibers of the wafer-thin felts absorb the marker color with a light wiping. The sponge acts as a holder, is protected, remains clean and does not need to be cleaned separately. For heavy or stubborn soiling, the UTENSILIO also has a cleaning fluid in a pump bottle. The quick-drying cleaning liquid prevents dripping while cleaning.

The board eraser fits seamlessly on the upper part of the UTENSILIO but will also stick separately exactly where it is needed.

The perfect pair: FATH UTENSILIO and FATH Visual Board with enameled surface

Thanks to its closed surface, the enameled **FATH Visual Board** is extremely resilient and particularly easy to clean – simply by dry wiping, without any residue. In combination with the **FATH UTENSILIO**, you have available a durable, practical and easy to manage visualization solution.



More about **FATH Visual Boards**:
visual-board.fath24.com



Would you like to learn more about **FATH UTENSILIO**?

utensilo.fath24.com

ORGANIZER UTENSILO, MAGNETIC (SET)

MODEL	For left- and right-handed use
DESCRIPTION	Fully equipped magnetic whiteboard organizer UTENSILO with cleaning spray, eraser and board markers; Ergonomically shaped magnetic eraser with easily replaceable felt pad, Variable bottle holder base to optimize ergonomics and accessibility from left or right; Compact design for minimal space requirements
MATERIAL	UTENSILO: Plastic ABS Magnets: Neodymium Bottle holder base: Plastic ABS Eraser: Plastic ABS / felt Spray bottle: Plastic HDPE Board marker: Plastic / felt
COLOR	UTENSILO: Gray ≈ RAL 7042 Bottle holder base: Gray ≈ RAL 7042 Eraser: Gray ≈ RAL 7042 Felt pad: Black Spray bottle: White Board marker body: White Board marker cap: Red, green, blue, black
SET	1 UTENSILO 1 bottle holder base 1 eraser with felt pad 1 cleaning spray 1 board marker red 1 board marker blue 1 board marker green 1 board marker black
PACK QUANTITY	1 set
TIP	Consumables can be reordered via adhered QR code: Compatible refill felt pad for eraser, self-adhesive see 0206FP91 Compatible cleaning spray for board marker see 0206U200CS Compatible board marker with felt eraser (Set) see 0206BM91

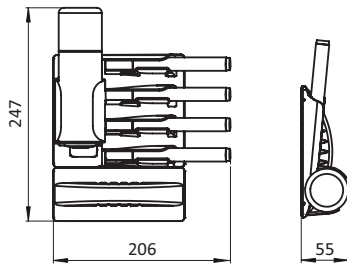

Weight [g] 540.0 Part # 0206U74

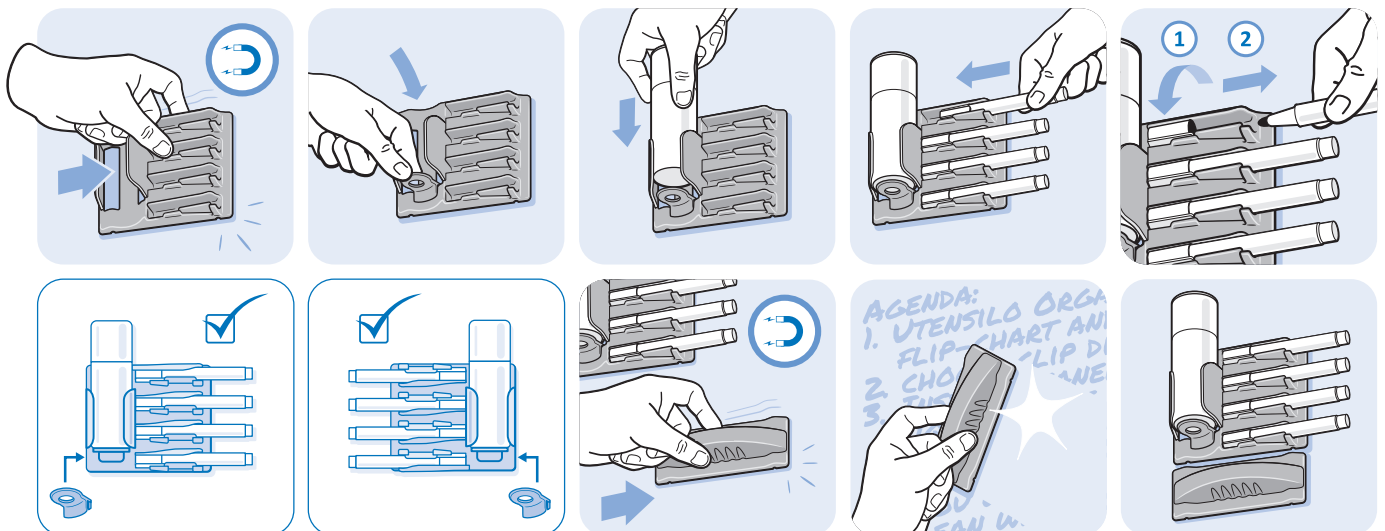

BOARD MARKER WITH FELT ERASER (SET)

MODEL	Diverse colors
DESCRIPTION	Board marker for whiteboards and visual boards With round tip, line width 3-4 mm, dry wipeable, font color detectable at cap color In practical folded box Enclosed eraser felts Matching with organizer UTENSILO
MATERIAL	Marker: Plastic Folded box: Cardboard Eraser felt: Felt
COLOR	Marker: White Cap: Writing color Eraser felt: Natural white Writing color: See table
DIMENSIONS	Marker: 138 x 15 mm Folded box: 143 x 80 x 16 mm
SET	4 board markers, sorted by color 4 felt erasers
PACK QUANTITY	1 set
TIP	Reorderable via adhered QR code

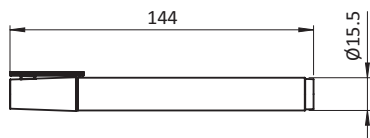

Font Color	Weight [g]	Part #
Black	15.8	0206BM91
Red	15.8	0206BM31
Blue	15.8	0206BM55
Green	15.8	0206BM63

CLEANING SPRAY FOR BOARD MARKER

MODEL	200 ml
DESCRIPTION	For efficient cleaning of white boards and visual boards high cleaning performance, with pump sprayer Matching with organizer UTENSILO
MATERIAL	Plastic HDPE
COLOR	White ≈ RAL 9001
PACK QUANTITY	4 pieces
TIP	Reorderable via adhered QR code

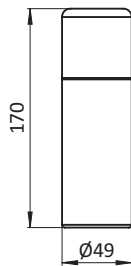

H [mm]	ØD [mm]	Weight [g]	Part #
170.0	49.0	235.0	0206U200CS

REFILL FELT PAD FOR ERASER, SELF-ADHESIVE

MODEL	Matching with wiper of organizer UTENSILO
DESCRIPTION	Easy exchange due to adhesive back, high durability, highly absorbent
MATERIAL	Felt
COLOR	Black
PACK QUANTITY	20 pieces
TIP	Reorderable via adhered QR code on board marker and cleaning spray

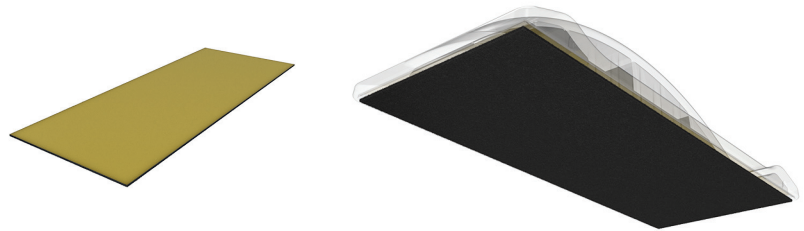
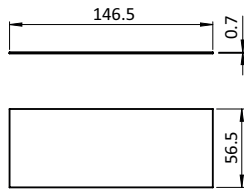

	Weight [g]	Part #
	79.5	0206FP91



FATH

FATH MAGNETIC DOCUMENT WINDOWS

Provide information in a clearly arranged, secured format with magnetic FATH's document windows



- Special printing concept
- Long-lasting frame color
- For document sizes A3 (11.7" x 16.5") and A4 (8.3" x 11.7")
- Can be used in landscape and portrait formats
- Available in many colors
- Clear structure

HIGHLIGHTS

What makes magnetic document windows so special: The frame color is printed on the inside. This procedure completely encloses the ink between the film and the magnetic strip, thus permanently protecting the print on both sides from wear and scratching. Color intensity is maintained even with prolonged use.

The different frame colors allow you to create a color index for specific products or define a color chart for topic blocks. For example, the 4mm wide color frame makes it possible to clearly identify and selectively communicate target achievements, quality, order backlogs, personnel deployment matrix, personnel qualification matrix, and general employee and company information. The color coding enables all employees to see relevant notices intuitively at a glance.

Visual boards and other metal information surfaces can be laid out in a neatly structured manner. Through the magnetic attachment, there are numerous application possibilities: On the shop floor visual boards to hold information on shift handovers or quality meetings. On enclosures and machine protection fencing to identify machines or on electrical control cabinets to advise circuit diagrams and safety instructions.

**STRONG HOLD
& HIGHLY VISIBLE**

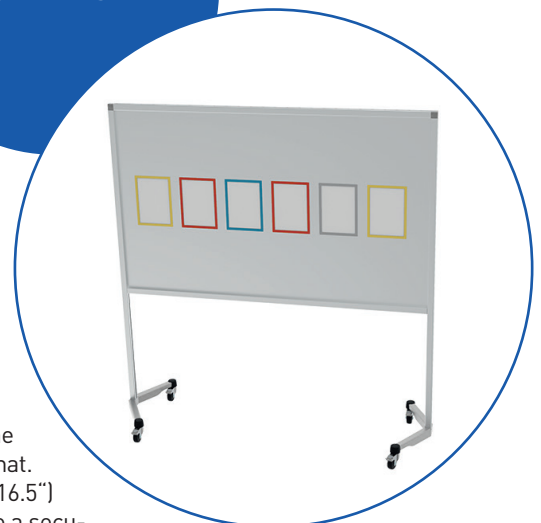

Quick and flexible information provision

You can use these magnetic document windows to attach required information and data to any metal board or surface using their simple, variable, clearly arranged format. The magnetic strips with extra strong adhesion on the back of the document window are designed to be used in either portrait or landscape format. The magnetic document windows are available for document sizes A3 (11.7" x 16.5") and A4 (8.3" x 11.7"). Receipts and documents can be changed instantly, provide a secure hold, and are protected from dirt by the transparent window. The transparent window is scanner readable and easy to clean.



FATH

Versions

The magnetic document windows are available in DIN A4 (8.3" x 11.7") and DIN A3 (11.7" x 16.5")

The following colors can be ordered:

- ① yellow
- ② red
- ③ blue
- ④ grey

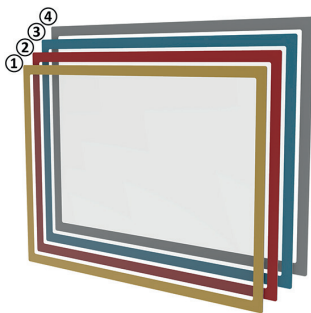

Visual Boards: everything at a glance

The **FATH** document windows can be used on the **FATH** Visual Boards, for example. Due to their magnetic effect, the document windows adhere very well to the enameled surface. This combination is simple, variable and clear. This is how lean works!



More about **FATH** Visual Boards:
visual-board.fath24.com

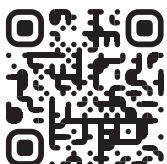

Would you learn more about **FATH** Document Windows?

document-window.fath24.com

MAGNETIC DOCUMENT WINDOW DIN A4 - 8.3" X 11.7"

MODEL	DIN A4 - 8.3" x 11.7" portrait / landscape format
DESCRIPTION	For variable and structured information provision through secure hold on metallic surfaces e.g. of visual boards / whiteboards; #b Color coding for different key figures or topic blocks, frame color permanently enclosed between outer foil and surrounding magnetic frame; Protects documents from dust and dirt, documents are easily exchangeable; Useable in portrait and landscape format, easy to reposition thanks to 4 magnetic sides
MATERIAL	Plastic PC
COLOR	Yellow, red, blue, gray
PACK QUANTITY	10 pieces

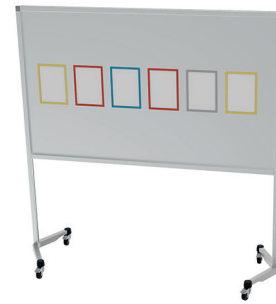
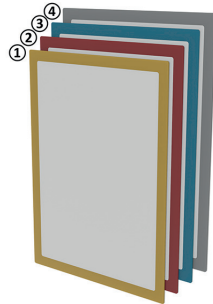
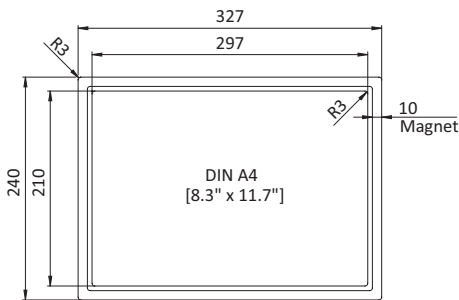

Fig.	Color	Weight [g]	Part #
①	Yellow ≈ RAL 1018	164.3	02065WA415
②	Red ≈ RAL 3020	164.3	02065WA431
③	Blue ≈ RAL 5017	164.3	02065WA455
④	Gray ≈ RAL 7045	164.3	02065WA475

MAGNETIC DOCUMENT WINDOW DIN A3 - 11.7" X 16.5"

MODEL	DIN A3 - 11.7" x 16.5" portrait / landscape format
DESCRIPTION	For variable and structured information provision through secure hold on metallic surfaces e.g. of visual boards / whiteboards; #b Color coding for different key figures or topic blocks, frame color permanently enclosed between outer foil and surrounding magnetic frame; Protects documents from dust and dirt, documents are easily exchangeable; Useable in portrait and landscape format, easy to reposition thanks to 4 magnetic sides
MATERIAL	Plastic PC
COLOR	Yellow, red, blue, gray
PACK QUANTITY	10 pieces

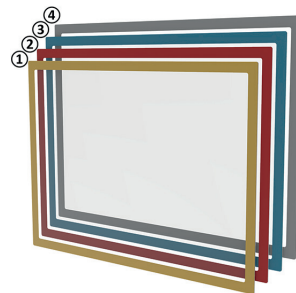
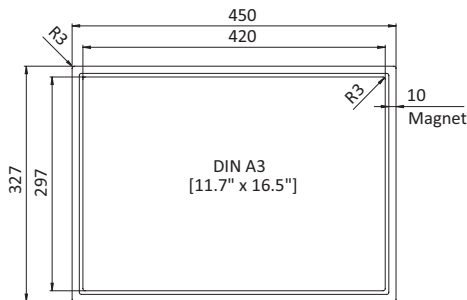

Fig.	Color	Weight [g]	Part #
①	Yellow ≈ RAL 1018	247.5	02065WA315
②	Red ≈ RAL 3020	247.5	02065WA331
③	Blue ≈ RAL 5017	247.5	02065WA355
④	Gray ≈ RAL 7045	247.5	02065WA375

MONITOR SUPPORT 5-AXIS, HEIGHT ADJUSTABLE (SET)

MODEL	5-axis
DESCRIPTION	for removable mounting of monitors with 2 - 10 kg, mounting plate VESA MIS-D 75/100 compatible; adjustable viewing angle and height, screen rotatable by 90°; 360° mounting flange for horizontal and vertical attachment with mounting adapter
MATERIAL	Mounting plate VESA, removable: Steel / Plastic Monitor mount: Die-cast aluminum Cable management cover: Plastic Bearing shims and bushes: Plastic Mounting flange: Die-cast aluminum Mounting adapter: Die-cast aluminum Screws: Steel
SURFACE	Mounting plate VESA, removable: Lacquered Monitor mount: Lacquered Mounting flange: Lacquered Mounting adapter: Lacquered Screws: Zinc plated
COLOR	Mounting plate VESA, removable: #b Alu color / black Monitor mount: Alu color Cable management cover: Black Bearing shims and bushes: Black Mounting flange: Alu color Mounting adapter: alu color
SET	1 mounting plate VESA with 4 screws – M4 × 12, Phillips 1 monitor support 5-axis with cable management cover 1 mounting flange 1 mounting screw DIN 6912 – M8 × 25 1 mounting adapter 2 mounting screws DIN 6912 – M8 × 16 1 hexagon key, AF 3 1 hexagon key, AF 4
PACK QUANTITY	1 set



Max. Load [kg]	Weight [g]	Part #
10.0	2930.0	6MHM75100D40



MONITOR SUPPORT 5-AXIS, HEIGHT ADJUSTABLE (SET)

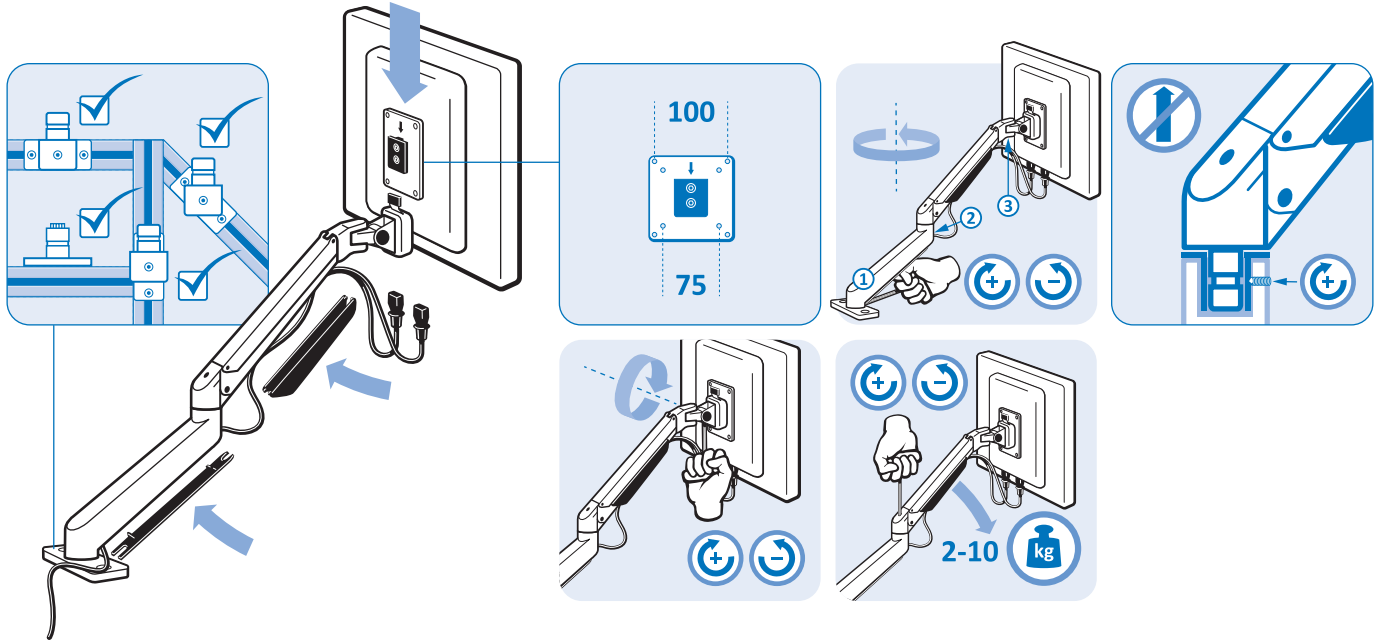

MONITOR SUSPENSION ARM SKY 600, HEIGHT ADJUSTABLE WITH LOCKING (SET)

MODEL	4-axis
DESCRIPTION	For mounting of heavy monitors with 6 - 12 kg, mounting plate VESA MIS-D 75/100 compatible, adjustable viewing angle and height; 360° mounting flange can be attached lateral or transverse to the profile
MATERIAL	Monitor suspension arm: Steel / aluminum / plastic Cable management cover: Plastic Mounting flange: Aluminum die-cast Screws: Steel
SURFACE	Monitor suspension arm: Lacquered Mounting flange: Lacquered Screws: Zinc plated
COLOR	Monitor suspension arm: Gray Cable management cover: Gray Mounting flange: Alu color
SET	1 monitor suspension arm incl. cable management cover 1 mounting flange incl. bolt and cover cap 2 screws DIN 912 - M8 x 30 (for T-slot nut) 2 centering plates - slot 8 2 centering plates - slot 10 2 anti-loss washers for screws M8 2 T-slot nuts - slot 8 - M8 2 T-slot nuts - slot 10 - M8 1 connecting ring 1 washer 4 screws DIN 799 - M4 x 16
PACK QUANTITY	1 set



Slot	Weight [g]	Profile	Part #
- / 8 / 10	10000.2	I	6SHM75100S40IF

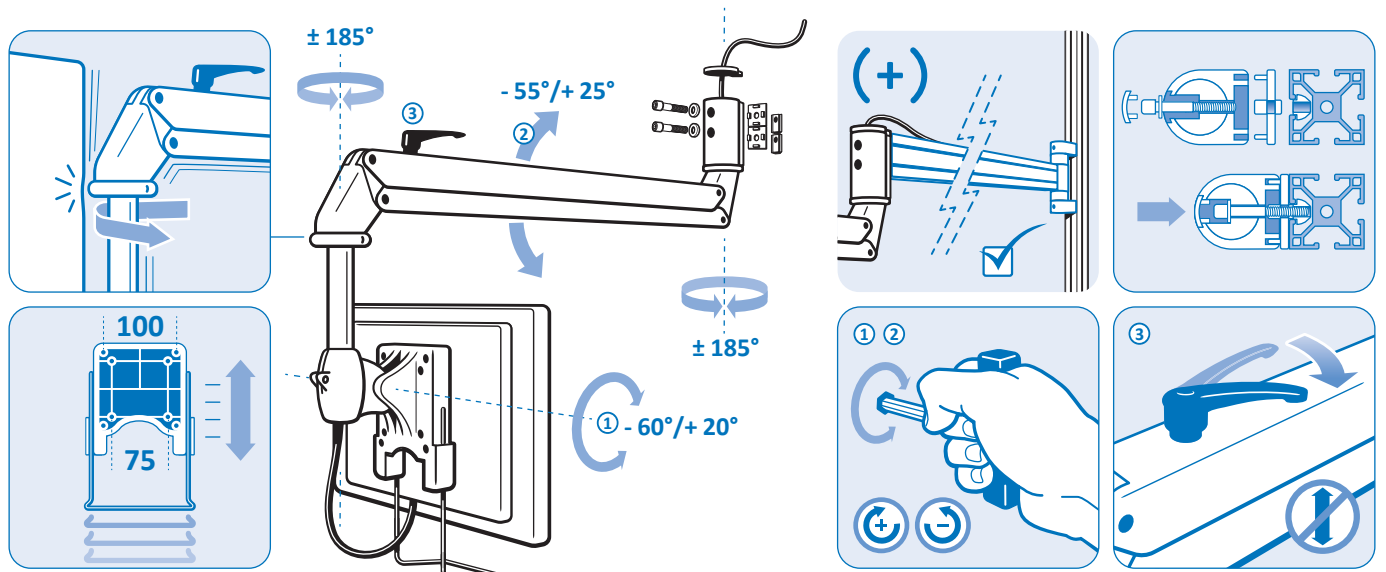

MONITOR WORK STATION SIT / STAND 4-AXIS, PROFILE ATTACHMENT (SET)

MODEL	4-axis
DESCRIPTION	For mounting of monitors with 2 - 8 kg, mounting plate VESA MIS-D 75/100 compatible, adjustable viewing angle and height; fold-up holder with wrist rest for keyboard up to 2.5 kg, incl. left or right pull-out shelf for mouse, as well as holders for hand scanner and mouse; 360° mounting flange can be attached lateral, transverse, or on the face of the profile, if attached on the front face, the core hole of the respective profile must be M8 threaded
MATERIAL	Monitor Work Station: Steel / aluminum / plastic Cable management cover: Plastic Mounting flange: Aluminum die-cast Screws: Steel
SURFACE	Monitor Work Station: Lacquered Mounting flange: Lacquered Screws: Zinc plated
COLOR	Monitor Work Station: Gray Cable management cover: Gray Mounting flange: Alu color
SET	1 monitor work station incl. keyboard holder and cable management cover 1 mounting flange incl. bolt and cover cap 1 screw DIN 912 - M8 x 45 (for T-slot nut) 1 screw DIN 912 - M8 x 50 (for core hole) 1 washer 8-FSt 1 centering plate - slot 8 1 centering plate - slot 10 1 T-slot nut - slot 8 - M8 1 T-slot nut - slot 10 - M8
PACK QUANTITY	1 set

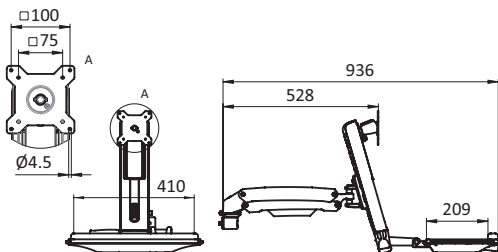

Slot	Weight [g]	Profile	Part #
- / 8 / 10	9200.0	I	6MHM75100S40IT



MONITOR WORK STATION SIT / STAND 4-AXIS, PROFILE ATTACHMENT (SET)

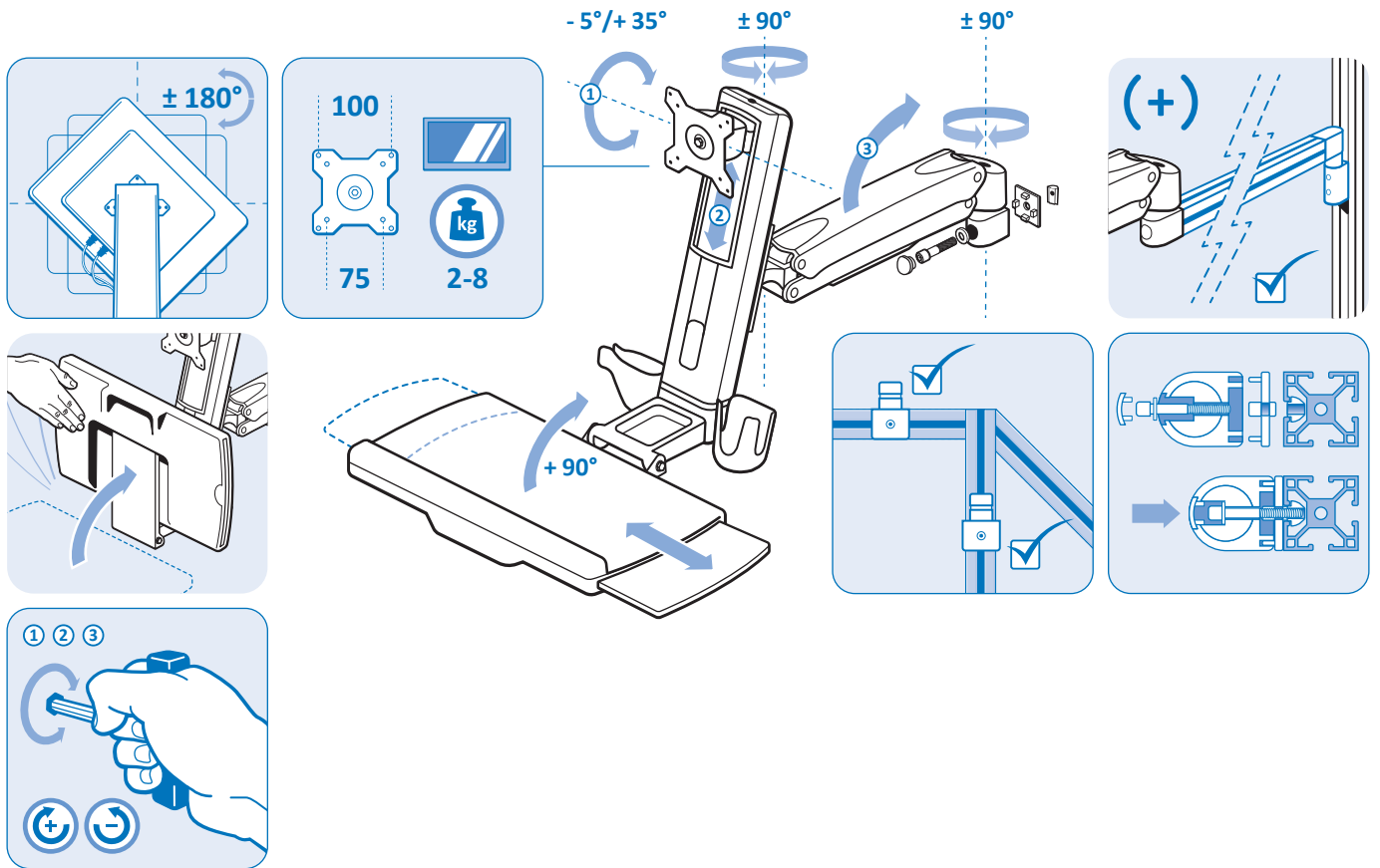

KEYBOARD HOLDER AL, SLOT 8 (SET)

MODEL	Aluminum
DESCRIPTION	For placing the keyboard and mouse, with wrist rest
MATERIAL	Keyboard holder: Aluminum, anodized Cover Caps: Plastic PA, glass ball reinforced Screws: Steel, zinc plated
SURFACE	Keyboard holder: Anodized Screws: Zinc plated
COLOR	Cover Caps: Gray
SET	1 keyboard holder, 2 cover caps, 8 screws 3.9 x 16
PACK QUANTITY	1 set
TIP	Compatible direct connectors see 099DC084040N08 and 099DC084045N10

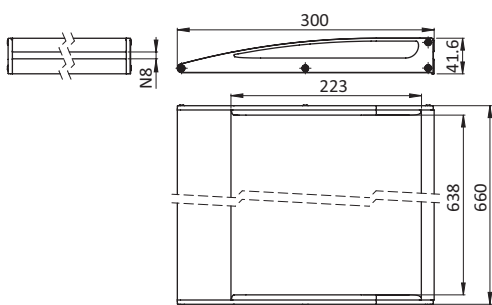

Slot	Weight [g]	Profile	Part #
8	2645.0	I	061KH300N0874.650

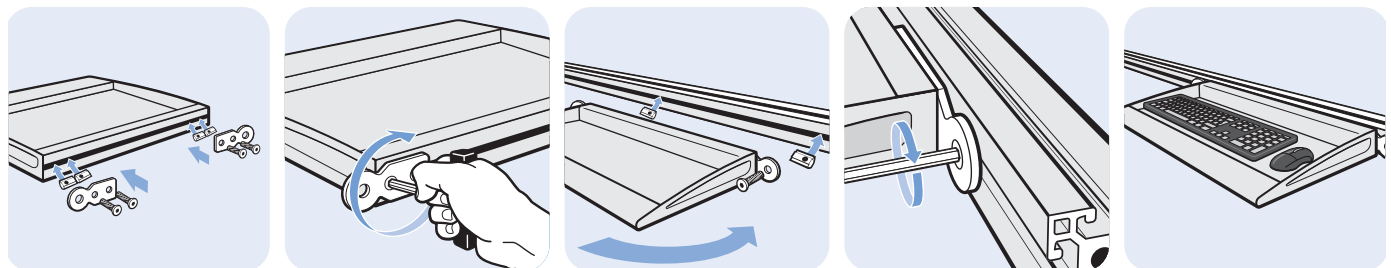

MATERIAL FLOW

Material Transport



Dollie for SLC 600 x 400,
with 4 Swivel Casters

197



Dollie for SLC 600 x 400,
with 2 Swivel and 2 Fixed Casters

198

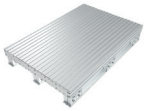

Extrusion Profile Pallet I8

202



FATH

DOLLIES

**Optimized material transport:
Reduced space requirements thanks to targeted provisioning with FATH Dollies**



- Empty dollies can be stacked to save space
- High load capacity up to 250 kg
- Versions with and without lateral guide
- Towing bar systems suitable for tugger trains
- Blicke brand wheels for all applications
- Suitable for adapter pallets
- Compatible and stackable with existing dollies

HIGHLIGHTS

With **FATH** Dollies, you can efficiently organize material provisioning in production and assembly while saving space – without using forklifts. The dollies are precisely designed for all KLT/Euro 400 x 600 mm containers and provide maximum flexibility in intralogistics for small and medium-sized batch sizes. As empties, they can be safely stacked and stored in a minimal amount of space. They also only require a small provisioning area on the shopfloor when loaded.

Made of galvanized steel and thanks to the welded frame construction, the dollies have an impressive high load-bearing capacity of up to 250 kg.

The dollies are also suitable for orderly and safe transport on adapter pallets. They are simply pushed into the rails of the adapter pallet. This facilitates storage of the dollies on high racks as well as cross-plant transport by truck and rail without time-consuming restacking.

FORKLIFT-FREE MATERIAL TRANSPORT



Blicke Germany brand quality wheels

All **FATH** rollers for dollies are equipped with high-quality wheels manufactured by Blicke Germany. The branded wheels manufactured in Germany are well-engineered and proven products and are very durable. Various versions of wheel types are available for all applications and application scenarios. Depending on your requirements, you can, for example, choose particularly quiet running, extremely anti-skid, non-marking or ESD wheels for your dollies.

Another advantage: All **FATH** rollers are securely and stably mounted on the dolly with a single centering screw.



FATH

Versions for every material handling requirement

FATH Dollies are available for a wide range of applications. They are equipped with 4 swivel casters for rolling in any direction or precise tracking with 2 swivel casters and 2 fixed casters and are also available with a towing bar system suitable for a tugger train. In the tugger train version, the coupling is located on the underside of the dolly and doesn't protrude. The towing bar can be folded out if necessary. When it is no longer needed, it automatically folds back into a vertical position by means of a spring mechanism. This means that the dollies with a coupling and towing bar can also be stored safely, save space and be transported on adapter pallets.

Side plates for containers without a deeper drawn base: If flat-bottomed crates are used for intralogistics, the version with side supports is optimal for transporting materials. The side plates are firmly welded to the long sides of the dollies, fix the containers in place and provide a secure hold without slipping or tipping, even when rolling over uneven surfaces.

Strong partners:

FATH Dollies and FATH Parking Rails

Combined with **FATH** Parking Rails, the **FATH** Dollie becomes a lean solution that provides significantly more structure and efficiency to material provision. **FATH** Parking Rails are simply glued on and enable precise positioning of the dollies without using brakes. This allows you to achieve a clear-cut order in the material feed and minimize space requirements.



More on **FATH** Parking Rails:
parking-rail.fath24.com



Would you like to learn more about **FATH** Dollies?

dollie.fath24.com

DOLLIE FOR SLC 600 X 400, WITH 4 SWIVEL CASTERS

MODEL	Pre-assembled
DESCRIPTION	For highest flexibility for inner company material supply Fits SLC and euro container Stackable
MATERIAL	Dollie frame: Steel Roller housing: Steel Caster: See table Screws: Steel
SURFACE	Dollie frame: Zinc plated Roller housing: Zinc plated Screws: Zinc plated
COLOR	Caster: See table
PACK QUANTITY	1 piece

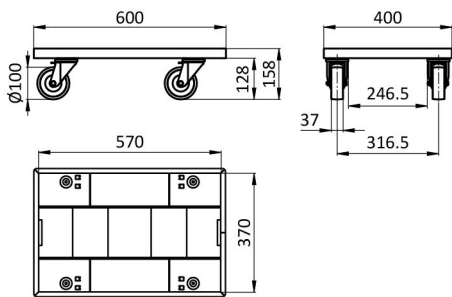

	Swivel Castor Tread	ESD	Color of Roller	Weight [g]	Part #
	Plastic PP		Black	5407.0	0207D1SS4WDS02
	Plastic PP	ESD	Black	5407.0	0207D1SS4WDS04
	Solid rubber		Gray	5407.0	0207D1SS4WDS03

DOLLIE FOR SLC 600 X 400, WITH 2 SWIVEL AND 2 FIXED CASTERS

MODEL	Pre-assembled
DESCRIPTION	For highest flexibility for inner company material supply Fits SLC and euro container Stackable
MATERIAL	Dollie frame: Steel Roller housing: Steel Caster: See table Screws: Steel
SURFACE	Dollie frame: Zinc plated Roller housing: Zinc plated Screws: Zinc plated
COLOR	Caster: See table
PACK QUANTITY	1 piece
TIP	Drawbar for dollie on request

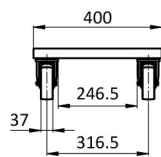
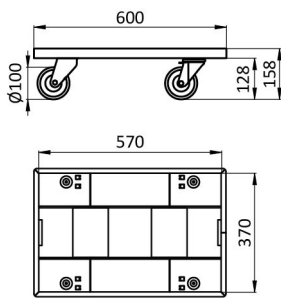

Swivel Castor Tread	ESD	Color of Roller	Fixed Castor Tread	Weight [g]	Part #
Plastic PP		Black	Plastic PP	5407.0	0207D1F2S2WDS02
	ESD	Black	Plastic PP	5407.0	0207D1F2S2WD004
Solid rubber		Gray	Solid rubber	5407.0	0207D1F2S2WDS03
Plastic PP		Black, gray	Solid rubber	5407.0	0207D1SF2S2WDS03



FATH

EXTRUSION PROFILE PLATE I8

FATH Extrusion Profile Plate I8: Innovative base for highly efficient work



- Slot plate size up to 5000 mm wide and 3340 mm long
- Can be used as a platform, pallet and large-format clamping plate
- Very durable, distortion-free and dimensionally stable
- Natural or anodized aluminum
- Sturdy aluminum cover caps available as accessories

HIGHLIGHTS

A new product from the **FATH LAB** – unique on the market in all its dimensions. The **FATH Extrusion Profile Plate I8** is a solution that can greatly simplify work processes in the industrial work environment. Made from lightweight, resilient aluminum profiles, it offers continuous slots on the top, bottom and sides and thereby opens up countless practical application possibilities for production & assembly, warehousing & logistics and the LEAN environment.

Individual constructions: The many slots on the entire surface of the **FATH Extrusion Profile Plate I8** result in highly flexible screw-on options. The complete system module for slot I8 is compatible, so you can easily build your construction based on the extrusion profile plate.

Whether as a clamping surface, for transport, as a storage option for special products, as a basis for a protective housing or as a slot wall – there are virtually no limits on ways to use it. Such flexibility is unattainable with wooden or plastic pallets.

WIDTH UP
TO 5 METERS



Unique size: extrusion profile plate up to 5 meters wide

An outstanding feature: Thanks to a special manufacturing process, the **FATH Extrusion Profile Plate I8** can attain a width of 5000 mm! You can select any width you require in a grid of 200 mm. The standard extrusion profile plate measures 800 mm x 1200 mm with a height of 80 mm. The maximum constructible length is 3340 mm. A **FATH Extrusion Profile Plate I8** in EU pallet size can bear a weight of up to two tons.



FATH

Use as a slot pallet, slot platform or large-format slot clamping plate

The following examples show only a fraction of the possibilities – let yourself be inspired.

As a pallet for warehouse & logistics

Choose the size of the **FATH** Extrusion Profile Plate I8 exactly according to your requirements, and it can become your customized pallet. With a lifting roller or swivel castor, you can turn it into a mobile platform for intralogistics. Made in standard Euro pallet size, the lightweight pallet easily fits into the pallet rack. The aluminum construction leaves no chips and is suitable for clean rooms. Even pre-produced core components for large machines can be stored cleanly and safely during the construction phase.

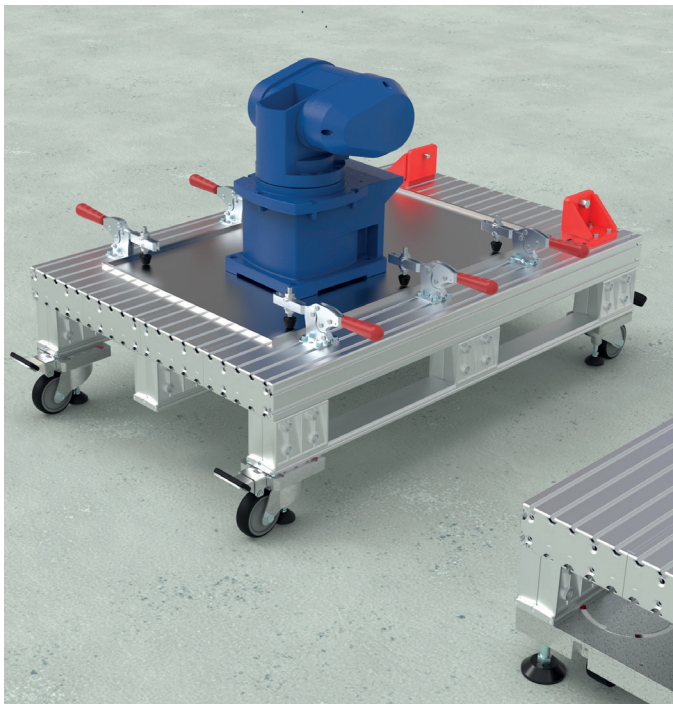

For transport

In mechanical engineering, the **FATH** Extrusion Profile Plate I8 can bring significantly more efficiency to the manufacturing process. Large workpieces can remain on the extrusion profile plate and be transported in the assembly hall for further processing steps. So you can implement uninterrupted flow production.

Even heavy work machines can be easily moved to where they are needed – securely clamped using the slots on the extrusion profile plate. A wide variety of rollers are available for use as transport trolleys.

As an integrative base plate for machines

The **FATH** Extrusion Profile Plate I8 can be used as an assembly platform in mechanical engineering and as the base element for the machine. The machine can be easily and stably fixed to the many T-slots so that the extrusion profile plate becomes an integral part of the final product.

As workpiece carrier or work table

As a mounting platform or clamping plate for the secure mounting of workpieces, tools, machines or robot arms on the many slots, the **FATH** Extrusion Profile Plate I8 can be transformed into a customized work and assembly table. The working height can be individually selected – for greater productivity while at the same time facilitating hand movements. This is also an advantage in terms of ergonomics! By screwing on rollers underneath the platform, you can easily make this workstation mobile. This means that the device can also support the production of very large products, as large components can be easily moved into the correct position and processed further with less effort.

Natural or anodized aluminum

In the standard version, the **FATH** Extrusion Profile Plate I8 is left untreated. This ensures a high level of surface robustness even in harsh environments and offers an excellent price-performance ratio. The extrusion profile plate is also available anodized on request. In this version, a width of up to 1200 mm with a length of 3340 mm is possible.



FATH

Accessories: Cover cap and pallet base

Special cover caps were developed for the **FATH** Extrusion Profile Plate I8 in the **FATH** LAB. They are screwed on at the side and securely close off the outer edges. The cover caps are made of aluminum for high durability and maximum stability. Thanks to the recesses, the slot ends remain free and T-slot nuts and other components can be easily inserted on the front sides.

Special pallet feet, matching skid profiles and cover caps are available for use as a slot pallet.



FATH components for unlimited mobility

Swivel and fixed casters, electric and hydraulic lift casters and lifting foot: **FATH** offers a full range of components with which you can move virtually any structure based on the **FATH** Extrusion Profile Plate I8. Choose the right caster for your application. The **FATH** Lift Caster is suitable for a smaller load. The new **FATH** Fixed Caster with a 200 mm diameter makes even heavy loads mobile.



Would you like to learn more about the **FATH** Profil Plate?

profil-plate.fath24.com

EXTRUSION PROFILE PALLET I8

MODEL	Pre-assembled
DESCRIPTION	Durable and universally to use, euro pallet size 1200 x 800mm Suitable for sensitive environments and clean rooms
MATERIAL	Aluminum plate: Aluminum Pallet foot half: Aluminum Skid Profile: Aluminum Cover cap for skid profile: Aluminum Cover cap for aluminum plate: Die-cast Aluminum Screws: Steel Hexagon nut: Steel
SURFACE	Aluminum plate: See table Screws: Zinc plated Hexagon nuts: Zinc plated
COLOR	Aluminum plate: Alu color Pallet foot half: Alu color Skid profile: Alu color Cover cap for skid profile: Alu color Cover cap for Aluminum plate: Alu color
PACK QUANTITY	1 piece

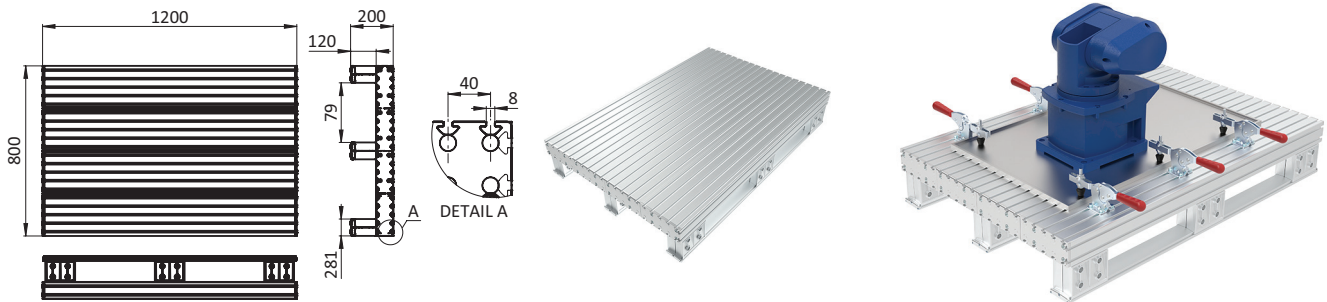

Slot	Surface	Weight [g]	Profile	Part #
8	Anodized	70000.0	I	2PI20080M4.1200ME
8	Plain	70000.0	I	2PI20080M4.1200MB

MATERIAL FLOW



Material Supply

9

Material Supply

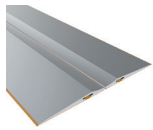

Parking Rail Low / Low (Set)

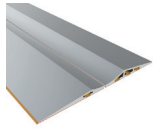
215

Parking Rail Low / High (Set)

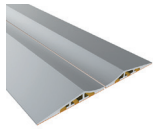
216

Parking Rail High / High (Set)

217

End Cap for Parking Rail Low / Low (Set)

218

End Cap for Parking Rail Low / High (Set)

219

End Cap for Parking Rail High / High (Set)

220

End Cap XL for Parking Rail Low / High (Set)

221

End Cap XL for Parking Rail High / High (Set)

222

Position Marking End Cap for Parking Rail

223

Guiding Rail FIFO (Set)

226

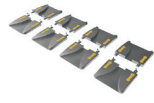

Infeed Cap for Guiding Rail FIFO (Set)

227



Screw Cover Infeed Cap for Guiding Rail FIFO

228



Mounting Set Infeed Cap for Guiding Rail FIFO

229

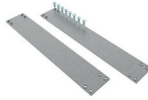

Connecting Element for Guiding Rail FIFO (Set)

230

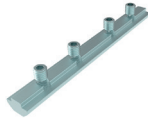

Connecting Strip 140 I, Slot 8 (Set)

231



Brush Brake for Guiding Rail FIFO

232



Adjustable Caster End Stop
for Guiding Rail FIFO (Set)

233



Cover Profile Slot 8 - 4.5

234







Angle Connector 40, 45°

235

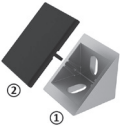
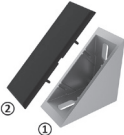

Angle Connector I 40, 45° (Set)

236

	Automatic Connector Steel	237
	Automatic Double Connector I, Slot 8 (Set)	238
	Milling Connector I, Slot 8 (Set)	239
	Plate Connector I ZN 40 (Set)	240
	Zinc Connection Angle 40 flat	241
	Zinc Connection Angle 40 / 80 flat	242
	Alu Connection Angle I40 M (Set)	243
	Alu Connection Angle I40 x 80 M (Set)	244
	Connection Plate I40 M Length/Cross, Rectangular 2 Hole, 1 Slot (Set)	245
	Connection Plate I120 M (Set)	246



Roll-in T-slot Nut 13.5 x 7.2 mm
with Spring Loaded Ball

247



FIFO Monorail Rail 40

248



Infeed cap for FIFO Monorail Rail 40 (Set)

249



Connecting Strip 180 B, Slot 8

250



Cover Profile Slot 8 - 2.2

251



Monorail Angle Connector for Posts (Set)

252



Monorail Angle Connector
for Post Support Struts (Set)

253



Automatic Connector Steel

254



Milling Connector B, Slot 8

255

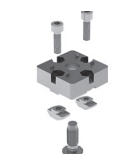
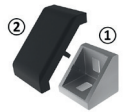

Plate Connector B AL (Set)

256



Alu Connection Angle 30

257



Alu Connection Angle 30 x 60

258



Roll-in T-slot Nut 11.6 x 4.6 mm with Spring Leaf

260



Outer T-Connector D30 - Slot 8 (Set)

261



T-connector Plate D28

262



T-Connector Plate D30 (Set)

263



Angle Connector 2D28 (Set)

264

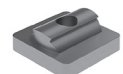

Adapter Plate D28 (Set)

265



Roller Track XST R28

266



Roller Track XST R28 with Flange

267



Roller Track XST H26

268

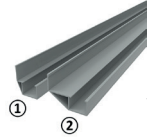

Guiding Rail XST Lateral

269



Guiding Rail XST Central

270

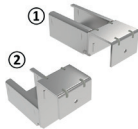

Holding Bracket ST / XST D28

271

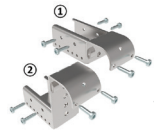

Holding Bracket ST / XST D30

272



Variable Holding Bracket ST / XST D28

273

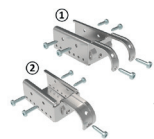

Variable Holding Bracket ST / XST D30

274



Mounting Bracket ST / XST D28

275



Mounting Bracket ST / XST D30

276



FATH

MATERIAL STOCKING IN PRODUCTION: IN CONVERSATION WITH THE EXPERTS

TIP

Who is not familiar with it:
Lack of floor space in assembly area

How to save space and reduce supply material to the assembly line in a space-saving and structured manner? Many customers ask themselves this question.

Our experts Michael Honisch (lean expert at **FATH**) and Theresia Diepold (expert in the field of digitalization at ambos.io) talk about this challenge in an interview. What about real-world situations and how can **FATH** help solve the problems?

In addition to many analog lean products, the **FATH** product world also has digital solutions that are easy to integrate. Everything works seamlessly together and when combined creates a completely new work experience. Best practice for lean production – and a sensible step on the way to digitalization in production.



**A combination of digital and analog
- for greater efficiency and productivity**

**Read the interview here and be inspired to optimize
your material supply.**

tip-fifo.fath24.com





FATH

PARKING RAILS

Precise, space-saving and safe positioning of Dollies



- Precise positioning of dollies and wagons
- Clear order in material management
- Efficient use of space
- More safety in the shopfloor area
Easy installation: place, glue down, ready to use
- One-piece signal end caps are separately available

HIGHLIGHTS

Lean your production processes in a simple way with the **FATH** parking rails. The parking rails mark the exact parking positions for dollies or in-house trolleys. By driving onto the rails, each employee automatically parks the wagons always accurately at the right position.

The required material is thus immediately available in the movement and gripping space of the assembly worker - targeted, structured and always in the right quantity. Even when robots are used, the parking rails ensure precise material supply. A waste of space is avoided by the orderly use of the floor and adjoining processes are not disturbed due to the low construction height of 6 to 10 millimetres - if no dollies are parked, the space can be freely used. High loads, such as driving over with industrial trucks, are no problem

for the robust aluminum rails.

The aluminum parking rails from **FATH** are underside coated with a high-performance industrial glue that guarantees extremely high adhesion. Remove the protective film, lay on the parking rails, stick the rails onto the floor over their entire surface - that's it! Small uneven areas in the floor and expansion gaps are compensated by the adhesive. The different height versions of the parking rails are designed for the different loads of the dollies. This ensures easy maneuvering into and out of parking spaces, as well as providing a firm restraint for lighter and heavier dollies. Low resistance when positioning dollies ensures smooth workflows that are gentle on the back.

SIGNAL EFFECT



Greater safety: Defined parking position and signal effect

The parking rails secure the floor dollies against unintentional movement. When filling or removing material, the carts are reliably held in position - even on uneven floors, without locking devices on the rollers. Driveways and walkways remain clear and production areas remain easily accessible. Groundbreaking: Bright yellow triangles in the end caps signal the exact position of the parking rails. This is a detail that facilitates efficient material feeding and provides additional safety. The flat tapered end caps also minimize the danger of tripping.



FATH

FATH Parking Rails are available in 3 versions

Modular lengths of 400, 800, 1200 and 2400 mm

High:
For light to medium weights

The double-sided 10 mm high version is particularly suitable for light and medium weights. Dollies can be moved in and out of the parking rail from both sides and are securely held in place.



Low – High:
For medium to heavy weights

The low – version with 6 mm / 10 mm height, ensures a clearly perceptible starting resistance and thus simplifies the positioning of the dolly on the parking rail. Pushing the dolly out over the flat side is particularly easy on the back, even with heavy weights, as only a small amount of force is required.



Low:
For heavy weights

The low design with a height of 6 mm on both sides allows heavy loads or loads that are difficult to maneuver, such as rollable garbage containers, to be parked and unparked effortlessly in both directions.



Accessories

Unique on the market: One-piece end caps
The self-adhesive end caps consist of a single piece – simply attach the end caps and press them onto the floor. Locking lugs ensure immediate correct positioning immediately. The undersides are coated with industrial-grade adhesive. The bonding prevents the ingress of impurities – and your hall floor is not damaged by drill holes.

The one-piece end caps are available in five complete sets for each parking rail version:

- End Cap (Set) High
- End Cap (Set) high, with parking rail distancing for large wheel diameters
- End Cap (Set) Low – High
- End Cap (Set) Low – High, with parking rail distancing for large wheel diameters
- End Cap (Set) Low



Would you like to learn more about **FATH** Parking Rails?

parking-rail.fath24.com

PARKING RAIL LOW / LOW (SET)

MODEL	Low / low, for heavy weights
DESCRIPTION	For precise positioning of dollies or material trolleys, suitable for different wheel diameters, no brakes needed; self-adhesive, for tool-free assembly, no screwing required, immediately ready for use
MATERIAL	Aluminum
SURFACE	Plain
FASTENING	Self-adhesive surface on the backside
PACK QUANTITY	1 set (= 2 pieces)
TIP	When ordering, please note: Replace "1200" in the part no. with the required length in mm, e.g. "0350" for 350 mm or "2000" for 2000 mm Compatible end cap for wheel diameter ≤ 100 mm see 02084LLS01

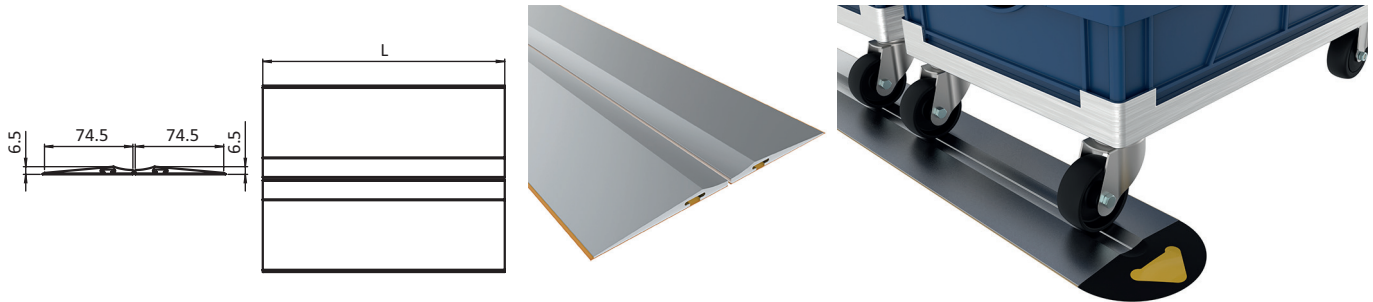

L [mm]	Weight [g]	Part #
400.0	520.0	02081ALL.0400
800.0	1060.0	02081ALL.0800
1200.0	1580.0	02081ALL.1200
2400.0	3200.0	02081ALL.2400

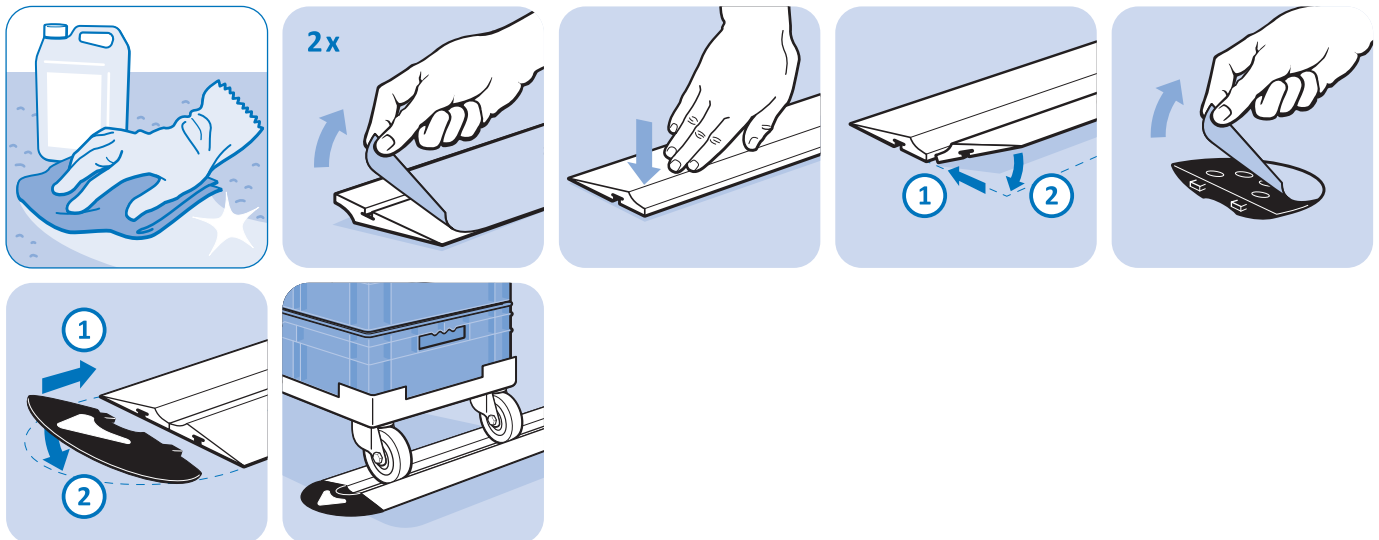

PARKING RAIL LOW / HIGH (SET)

MODEL	Low / high, for medium to heavy weights
DESCRIPTION	For precise positioning of dollies or material trolleys, suitable for different wheel diameters, no brakes needed; self-adhesive, for tool-free assembly, no screwing required, immediately ready for use
MATERIAL	Aluminum
SURFACE	Plain
FASTENING	Self-adhesive surface on the backside
PACK QUANTITY	1 set (= 2 pieces)
TIP	When ordering, please note: Replace "1200" in the part no. with the required length in mm, e.g. "0350" for 350 mm or "2000" for 2000 mm Compatible end cap for wheel diameter ≤ 100 mm see 02084LHS01 Compatible end cap XL for wheel diameter > 100 mm see 02084LHXS01

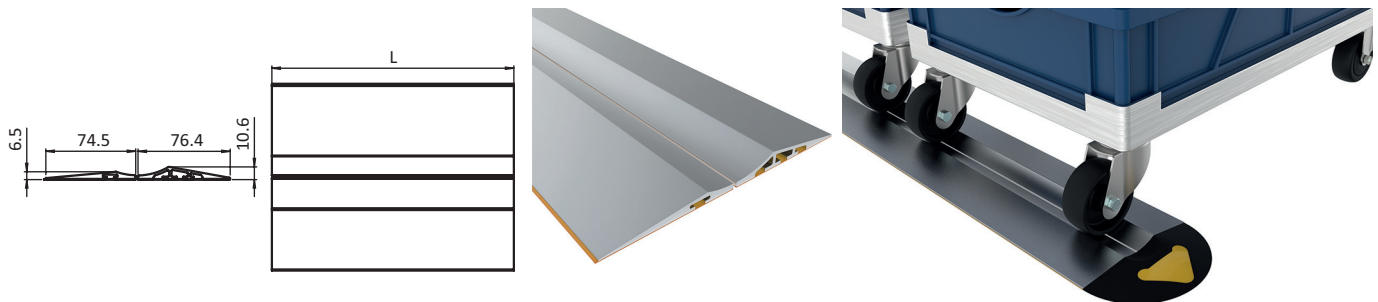

L [mm]	Weight [g]	Part #
400.0	570.0	02081ALH.0400
800.0	1120.0	02081ALH.0800
1200.0	1750.0	02081ALH.1200
2400.0	3500.0	02081ALH.2400

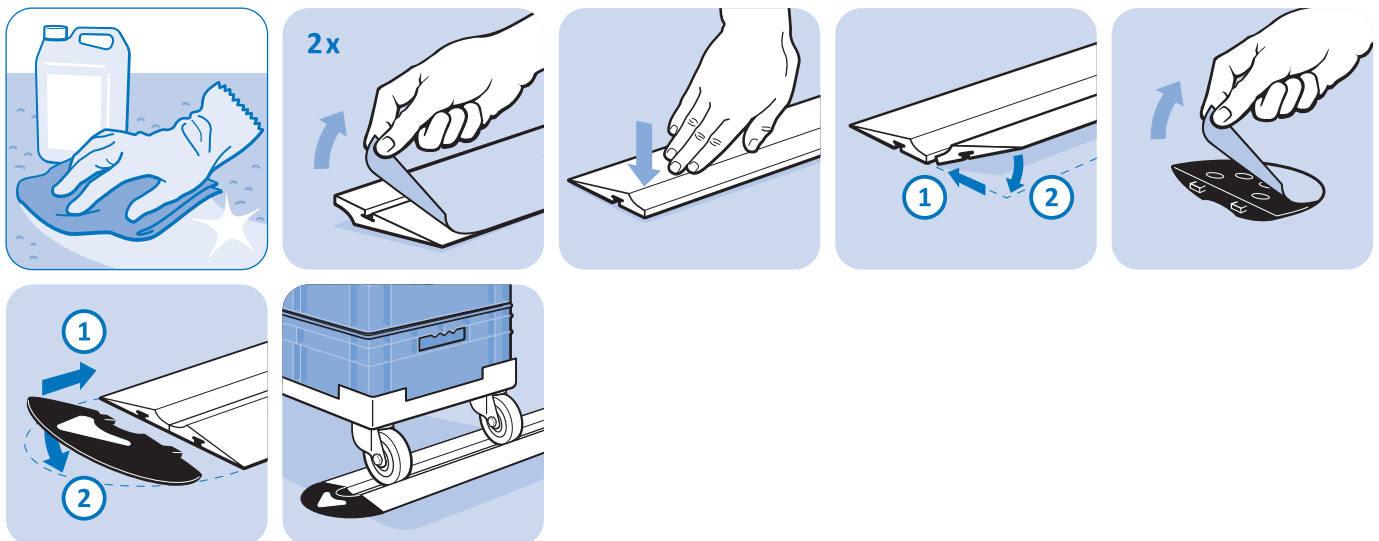

PARKING RAIL HIGH / HIGH (SET)

MODEL	High / high, for light to medium weights
DESCRIPTION	For precise positioning of dollies or material trolleys, suitable for different wheel diameters, no brakes needed; self-adhesive, for tool-free assembly, no screwing required, immediately ready for use
MATERIAL	Aluminum
SURFACE	Plain
FASTENING	Self-adhesive surface on the backside
PACK QUANTITY	1 set (= 2 pieces)
TIP	When ordering, please note: Replace "1200" in the part no. with the required length in mm, e.g. "0350" for 350 mm or "2000" for 2000 mm Compatible end cap for wheel diameter ≤ 100 mm see 02084HHS01 Compatible end cap XL for wheel diameter > 100 mm see 02084HHXLS01

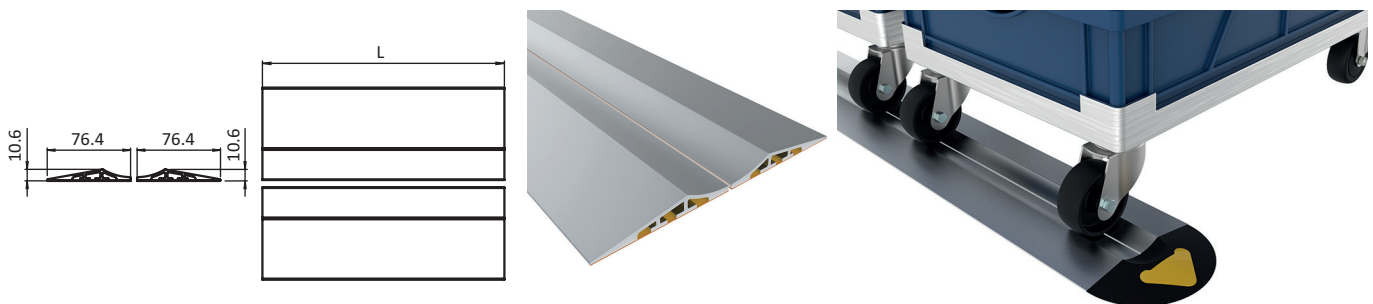

L [mm]	Weight [g]	Part #
400.0	600.0	02081AHH.0400
800.0	1200.0	02081AHH.0800
1200.0	1800.0	02081AHH.1200
2400.0	3600.0	02081AHH.2400

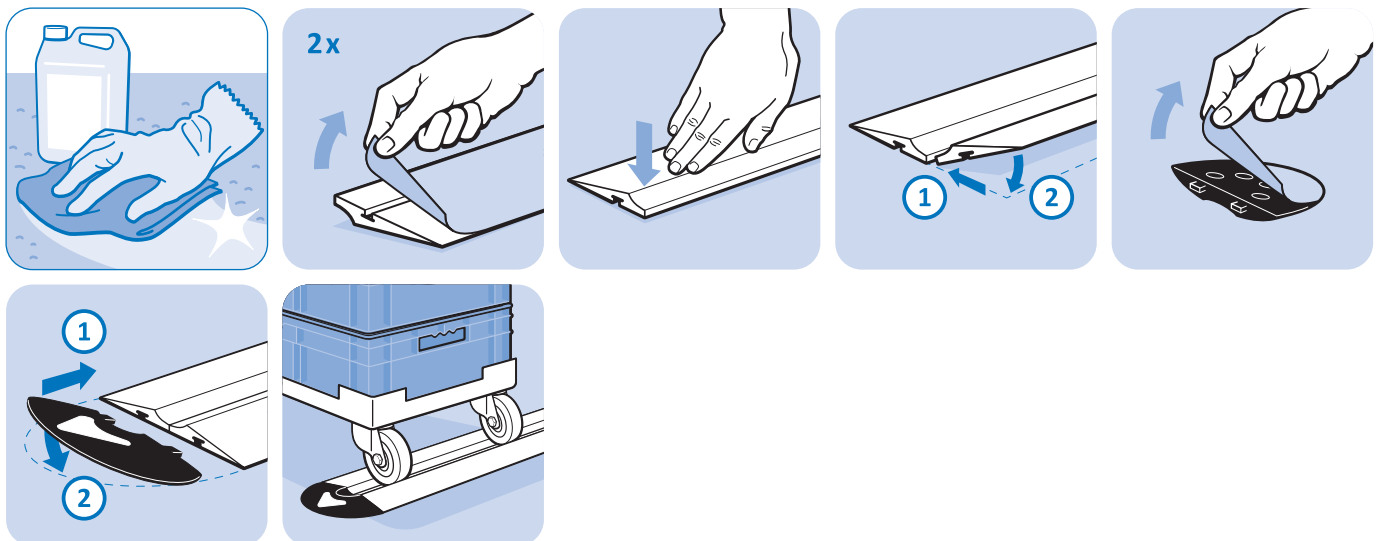

END CAP FOR PARKING RAIL LOW / LOW (SET)

MODEL	Standard version, for wheel diameter ≤ 100 mm
DESCRIPTION	One-piece end caps; self-adhesive; Yellow position markings with signal effect to indicate the position of the wheels from floor dollies or material trolleys in the parking rail
MATERIAL	End caps: Plastic PA, glass ball reinforced Position markings: Plastic PET
COLOR	End caps: black Position markings: yellow ≈ RAL 1003 Screw-on set (optional) plastic anchor: Yellow
SET	2 end caps 2 position markings
FASTENING	Self-adhesive surface on the backside
PACK QUANTITY	1 set
TIP	Compatible parking rail low / low (set) for heavy weights see 02081ALL.0400, Compatible position marking as replacement see 02084S.15

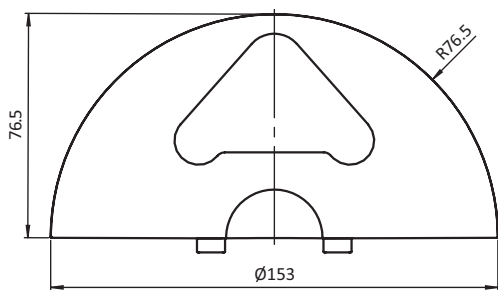

for Wheel Diameter	Weight [g]	Part #
≤ 100 mm	66.0	02084LLS01

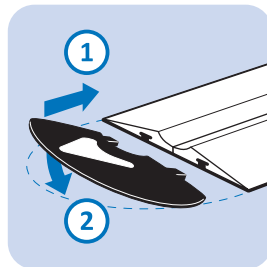
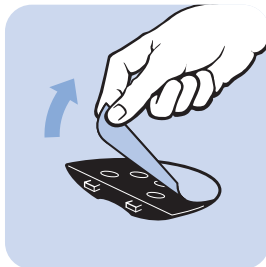

END CAP FOR PARKING RAIL LOW / HIGH (SET)

MODEL	Standard version, for wheel diameter ≤ 100 mm
DESCRIPTION	One-piece end caps; self-adhesive; Yellow position markings with signal effect to indicate the position of the wheels from floor dollies or material trolleys in the parking rail
MATERIAL	End caps: Plastic PA, glass ball reinforced Position markings: Plastic PET
COLOR	End caps: black Position markings: yellow ≈ RAL 1003 Screw-on set (optional) plastic anchor: Yellow
SET	1 end cap left, 1 end cap right, 2 position markings
FASTENING	Self-adhesive surface on the backside
PACK QUANTITY	1 set
TIP	Compatible parking rail low / high (set) for medium to heavy weights see 02081ALH.0400, Compatible position marking as replacement see 02084S.15

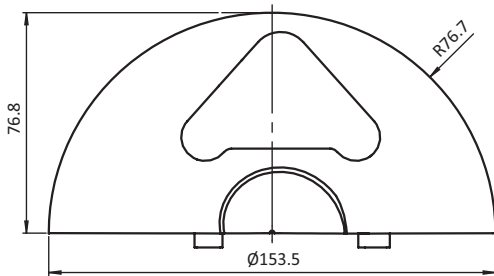

for Wheel Diameter	Weight [g]	Part #
≤ 100 mm	80.0	02084LHS01

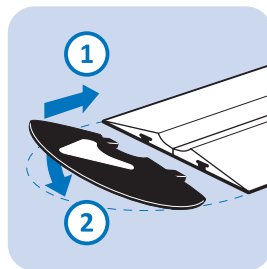

END CAP FOR PARKING RAIL HIGH / HIGH (SET)

MODEL	Standard version, for wheel diameter ≤ 100 mm
DESCRIPTION	One-piece end caps; self-adhesive, screwable with optional screw-on set; Yellow position markings with signal effect to indicate the position of the wheels from floor dollies or material trolleys in the parking rail
MATERIAL	End caps: Plastic PA, glass ball reinforced Position markings: Plastic PET Screw-on set (optional) screw: Steel Screw-on set (optional) plastic anchor: Plastic
SURFACE	Screw-on set (optional) screw: Zinc Plated
COLOR	End caps: black Position markings: yellow ≈ RAL 1003 Screw-on set (optional) plastic anchor: Yellow
SET	2 end caps 2 position markings
ASSEMBLY SET	1 screw-on set (optional): 4 board screws, 4 plastic anchors, 2 position markings
FASTENING	Self-adhesive surface on the backside
PACK QUANTITY	1 set
TIP	Compatible parking rail high / high (set) for light to medium weights see 02081AHH.0400, Compatible position marking as replacement see 02084S.15

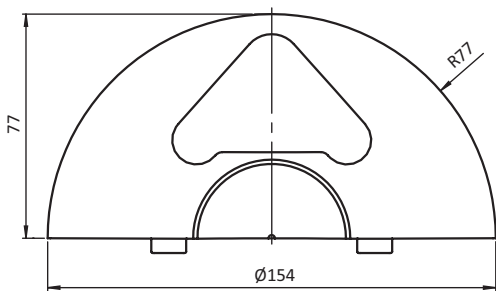

Version	for Wheel Diameter	Weight [g]	Part #
	≤ 100 mm	70.0	02084HHS01
Screw-on Set End Cap for Parking Rail		47.0	02084R01

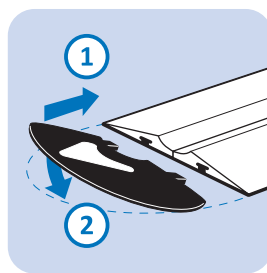
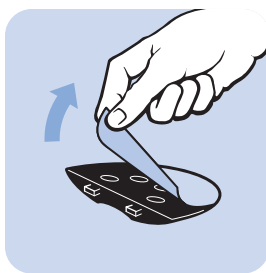

END CAP XL FOR PARKING RAIL LOW / HIGH (SET)

MODEL	XL version, for wheel diameter > 100 mm
DESCRIPTION	One-piece XL end caps, no spacers required for large wheel diameters; self-adhesive; Yellow position markings with signal effect to indicate the position of the wheels from floor dollies or material trolleys in the parking rail
MATERIAL	End caps: Plastic PA, glass ball reinforced Position markings: Plastic PET
COLOR	End caps: black Position markings: yellow ≈ RAL 1003 Screw-on set (optional) plastic anchor: Yellow
SET	1 XL end cap left, 1 XL end cap right, 2 position markings
FASTENING	Self-adhesive surface on the backside
PACK QUANTITY	1 set
TIP	Compatible parking rail low / high (set) for medium to heavy weights see 02081ALH.0400, Compatible position marking as replacement see 02084S.15

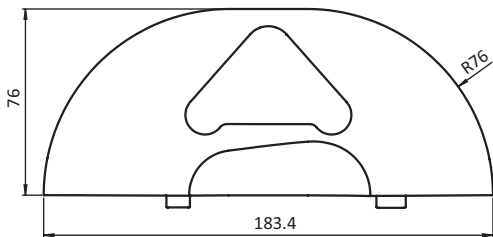

for Wheel Diameter	Weight [g]	Part #
> 100 mm	100.0	02084LHXL01

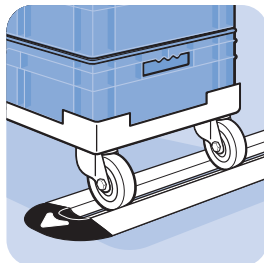
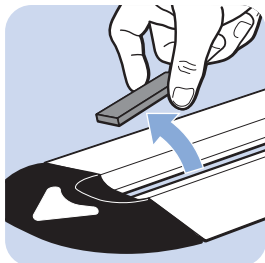
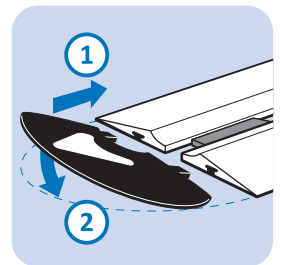
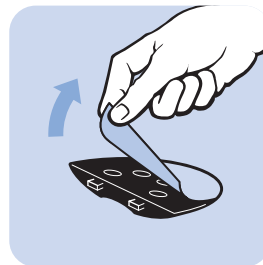
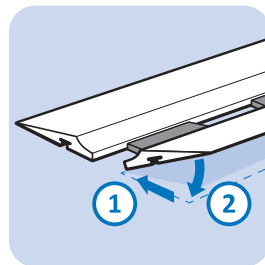
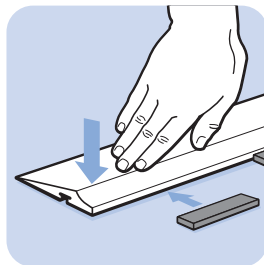

END CAP XL FOR PARKING RAIL HIGH / HIGH (SET)

MODEL	XL version, for wheel diameter > 100 mm
DESCRIPTION	One-piece XL end caps, no spacers required for large wheel diameters; self-adhesive, screwable with optional screw-on set; Yellow position markings with signal effect to indicate the position of the wheels from floor dollies or material trolleys in the parking rail
MATERIAL	End caps: Plastic PA, glass ball reinforced Position markings: Plastic PET Screw-on set (optional) screw: Steel Screw-on set (optional) plastic anchor: Plastic
SURFACE	Screw-on set (optional) screw: Zinc Plated
COLOR	End caps: black Position markings: yellow ≈ RAL 1003 Screw-on set (optional) plastic anchor: Yellow
SET	2 XL end caps 2 position markings
ASSEMBLY SET	1 screw-on set (optional): 4 board screws, 4 plastic anchors, 2 position markings
FASTENING	Self-adhesive surface on the backside
PACK QUANTITY	1 set
TIP	Compatible parking rail high / high (set) for light to medium weights see 02081AHH.0400, Compatible position marking as replacement see 02084S.15

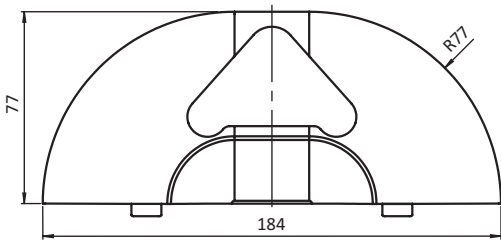

Version	for Wheel Diameter	Weight [g]	Part #
	> 100 mm	100.0	02084HHXS01
Screw-on Set End Cap for Parking Rail		47.0	02084R01

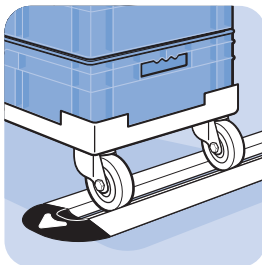
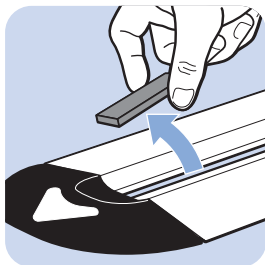
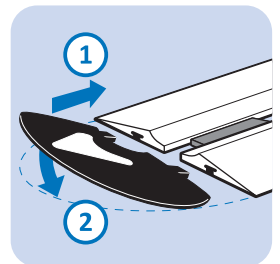
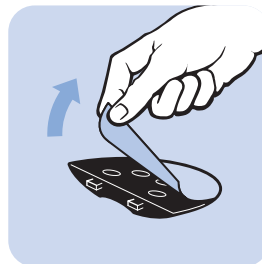
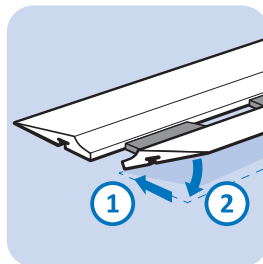
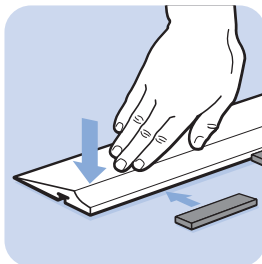

POSITION MARKING END CAP FOR PARKING RAIL

MODEL	Self-adhesive
DESCRIPTION	To cover the screw holes of end caps for parking rail; Yellow position markings with signal effect to indicate the position of the wheels from floor dollies or material trolleys in the parking rail; Included in the end cap sets, here separately available as replacement
MATERIAL	Plastic PET
COLOR	Yellow ≈ RAL 1003
FASTENING	Self-adhesive surface on the backside
PACK QUANTITY	1 piece

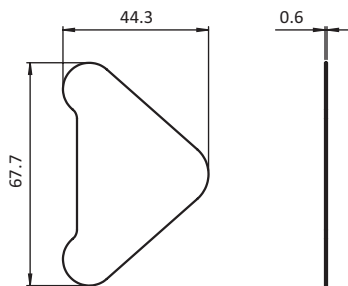

Weight [g]	Part #
2.0	02084S.15



FATH

FIFO GUIDING RAILS

Build a FIFO station based on need while saving space with FATH Guiding Rails FIFO



- Modular system – scalable at any time
- Extra wide, break-proof insertion caps
- Upward-facing profile slots for cost-effective enclosure
- Floating installation without screwed joints
- Space-saving thanks to One-sided rail guide

HIGHLIGHTS

Due to the modular design, the FIFO-station can be flexibly adapted in length and width. You can set up your FIFO-station exactly according to individual requirements and expand it at any time. The Guiding Rails FIFO are bolted together with connecting plates directly at the infeed caps. This connecting element ensures stability and specifies the track width. The number of tracks can be selected as required.

In order to achieve the desired track length, the individual Guiding Rails FIFO are joined together by means of a longitudinal connector. The Guiding Rails FIFO are available in the standard lengths 1200, 1800 and 2400 mm and on request in the specific length you require.

The **FATH** Guiding Rails FIFO are laid in a floating manner. The FIFO track does not have to be

screwed to the floor to rest securely, which protects the hall floor. The rails are held by the dead weight of the floor rollers. For special requirements, bolting to the floor is optionally possible; the holes are already integrated in the insertion caps.

One guide rail per track is sufficient for the safe placement of the floor rollers. The side on which the floor roller is guided can be freely selected. For three tracks, for example, only three Guiding Rails FIFO are required. This reduces costs, saves space and offers additional flexibility.



EFFICIENT MATERIAL SUPPLY

Innovative: Extra-wide insertion caps for easy threading of floor rollers

FATH has redesigned the infeed caps for even more efficiency in handling the floor rollers. The extra wide designed opening acts like a funnel and makes loading the FIFO station much easier. Even if the rollers are not visible at all under the boxes, they can be threaded effortlessly into the rail. The insertion caps are mounted at the front and rear end of each track. This allows the FIFO principle (First-In-First-Out) to be implemented perfectly - for an optimized internal flow of goods. Another strong plus: The **FATH** infeed caps for the FIFO station are manufactured using the aluminum die-casting process and, unlike conventional plastic caps, are break-resistant.

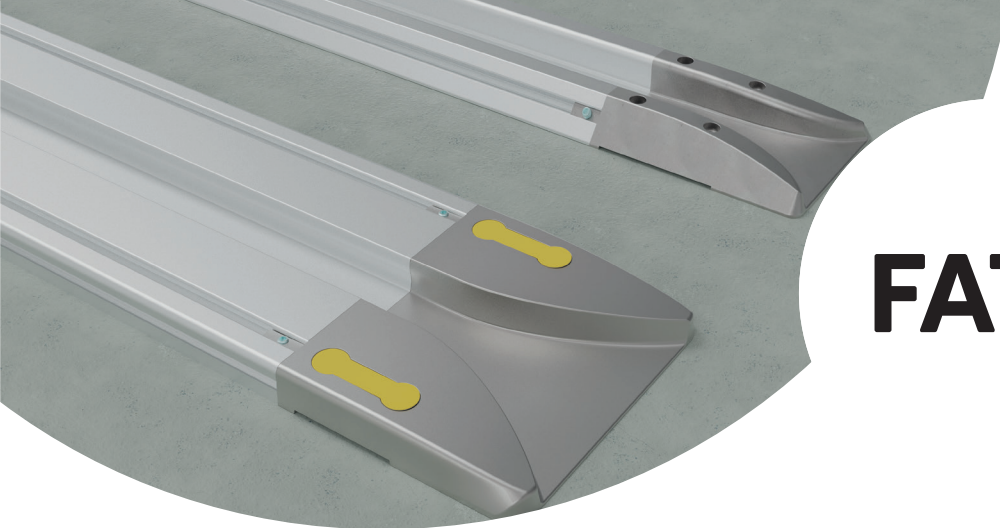

FATH

The FATH Guiding Rails FIFO are available in two designs:

One design is unique on the market: rectangular joints allow a cost-effective enclosure, for example for marking tracks. Due to the 8 profile groove incorporated in the Guiding Rails FIFO, superstructures with all common 40 x 40mm profiles can be easily mounted. A post for the signage is simply placed from above at a 90° angle and securely anchored in the groove. Integration on protective enclosures is also possible without complications.

The other version (the standard product) has a more compact design and thus a slimmer structure. The Guiding Rails FIFO have an outer contour that is beveled at 45° and have a 10 mm groove on the angled side of the rail for superstructures with 30 x 30 mm profiles. With this 45° adaptation, a post is placed with a 45° angled connector. Superstructures or enclosures can be implemented in any shape. This design is compatible with rails already available on the market, but comes up trumps with a special quality feature: The die-cast aluminum insertion caps are significantly more stable than the plastic caps commonly available on the market.



Perfect interaction: FATH Guiding Rails FIFO and FATH Dollies.

In combination with the **FATH** Dollies, material supply becomes even more efficient. The floor rollers are designed to fit all KLT/Euro containers 400 x 600 mm and offer a high load capacity of up to 250 kg. As empties, they can be stacked to save space and stored in the smallest of spaces. Versions are available with and without side guides and with drawbar systems suitable for tugger trains. All **FATH** castors for floor rollers are equipped with high-quality wheels from the manufacturer Blickle Germany.

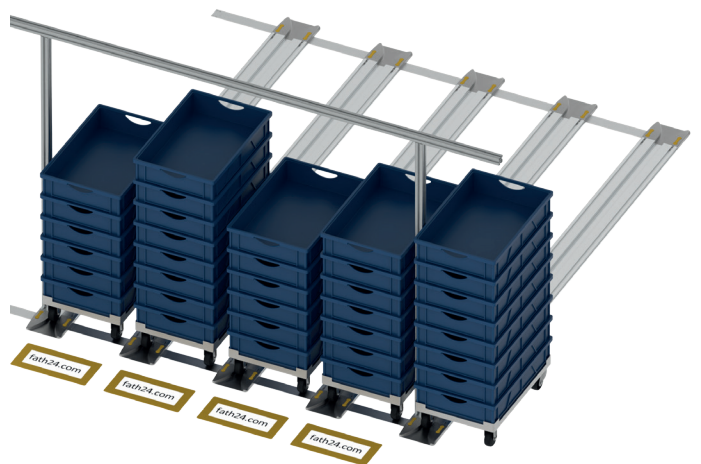

More about the **FATH** Dollies:
dollie.fath24.com



Would you like to learn more about
FATH Guiding Rails FIFO ?

guiding-rail.fath24.com

GUIDING RAIL FIFO (SET)

MODEL	Aluminum, anodized
DESCRIPTION	For guiding floor dollies on one side in FIFO stations, with a wheel width of up to 40 mm with 2 slots at the top, bottom and sides; to extend two guiding rails, connect them face to face with connecting strip in the slots; sign posts can be mounted in the slot from above
MATERIAL	Aluminum
SURFACE	Anodized
PACK QUANTITY	1 set (= 4 pieces)
TIP	When ordering, please note: Replace "1200" in the part no. with the required length in mm, e.g. "0350" for 350 mm or "2000" for 2000 mm Compatible connecting strip see 096060S02 Compatible infeed cap for guiding rail FIFO see 02082CCS01 Compatible cover profile see 092080

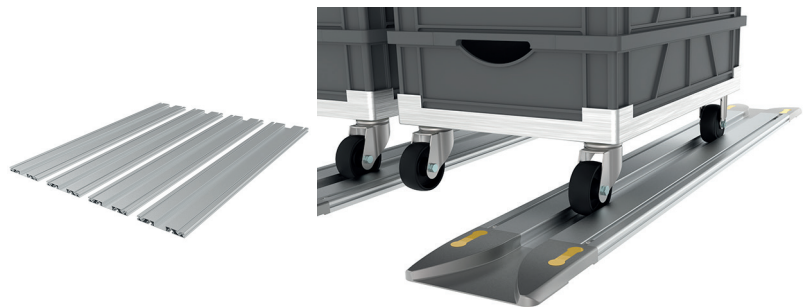
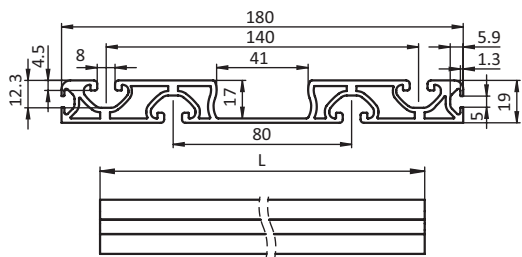

L [mm]	Weight [g]	Profile	Part #
1200.0	3850.0	I	02082P.1200
1800.0	5774.0	I	02082P.1800
2400.0	7699.0	I	02082P.2400

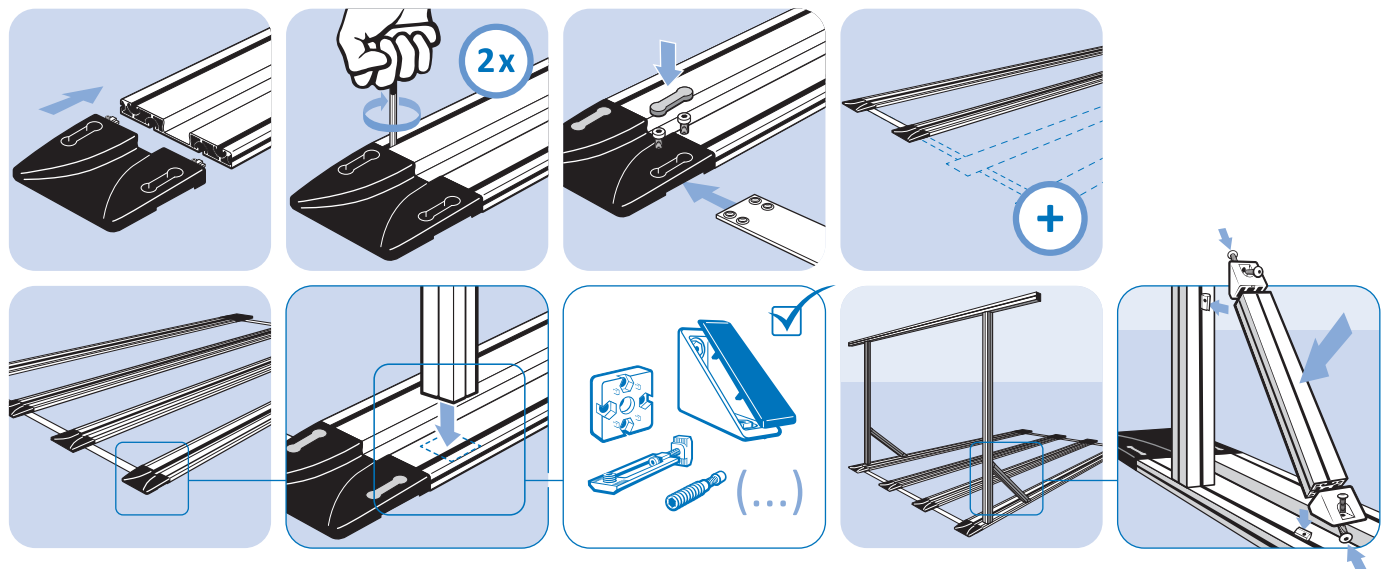

INFEED CAP FOR GUIDING RAIL FIFO (SET)

MODEL	Aluminum die-cast
DESCRIPTION	For easier loading and unloading of a FIFO stations with floor dollies; Robust design, mounting directly in the slot of guiding rails FIFO with enclosed hexagon socket set screws Yellow screw cover with signal effect to indicate the infeed position for the wheels of floor dollies
MATERIAL	Infeed Caps: Aluminum die-cast Screw Covers: Plastic PC Hexagon socket set screws: Steel
SURFACE	Infeed caps: Alu color powder coated Hexagon socket set screws: Zinc plated
COLOR	Screw Covers: Yellow ≈ RAL 1003
SET	8 infeed caps 16 screw covers 16 hexagon socket set screws ISO 4027 - M6 x 8
FASTENING	From the front, using M6 countersunk screws
PACK QUANTITY	1 set
TIP	Compatible guiding rails FIFO see 02082P.1200 Compatible connecting element for guiding rail FIFO see 02082D Compatible fastening set see 02082FS Compatible screw cover infeed cap for guiding rail FIFO as spare part see 02082S.15

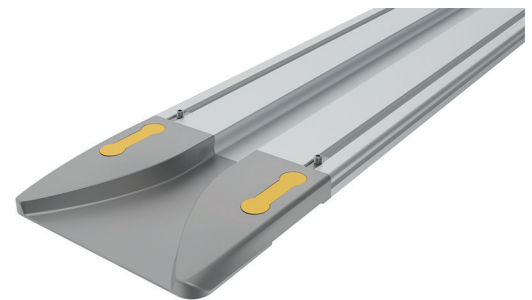
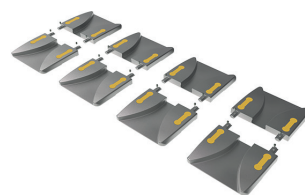
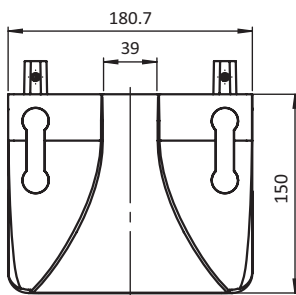

Weight [g]	Part #
3.348	02082CCS01

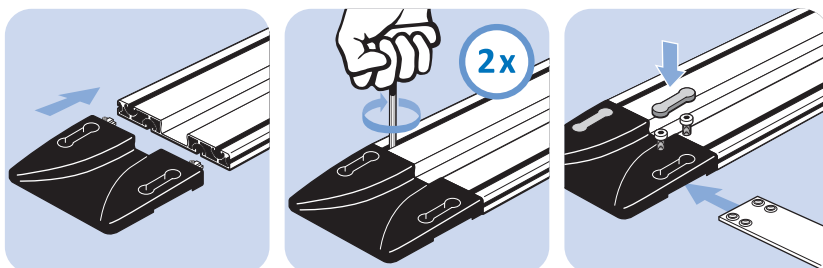

SCREW COVER INFEED CAP FOR GUIDING RAIL FIFO

MODEL	Self-adhesive
DESCRIPTION	To cover the screw holes of infeed caps for guiding rail FIFO; Yellow screw cover with signal effect to indicate the infeed position for the wheels of floor dollies; Included in the infeed cap set, here separately available as replacement
MATERIAL	Plastic PC
COLOR	Yellow ≈ RAL 1003
FASTENING	Self-adhesive surface on the backside
PACK QUANTITY	20 pieces

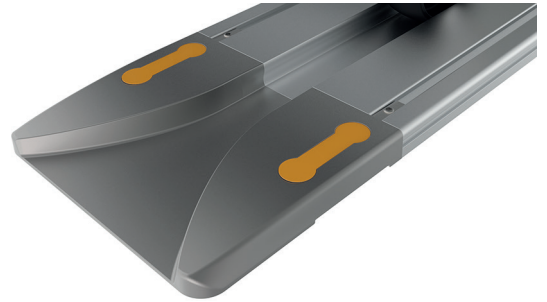
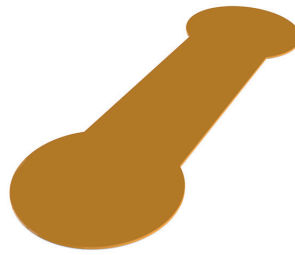
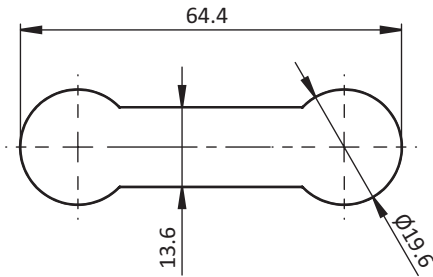

Weight [g]

Part #

7.5

02082S.15

MOUNTING SET INFEED CAP FOR GUIDING RAIL FIFO

MODEL	Steel
DESCRIPTION	To mount infeed caps for guiding rails FIFO to the floor
MATERIAL	Anchor: Plastic Screws: Steel
SURFACE	Screws: Galvanized
COLOR	Anchor: Yellow
SET	8 anchors 8 x 60 8 screws 5 x 60
PACK QUANTITY	1 set

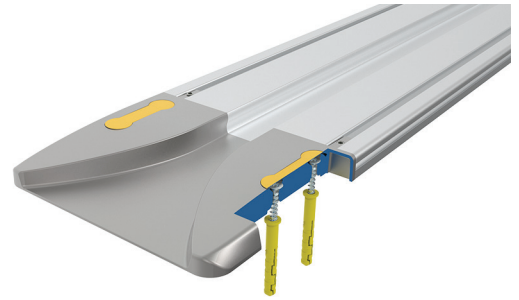
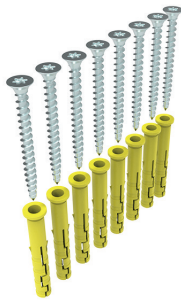
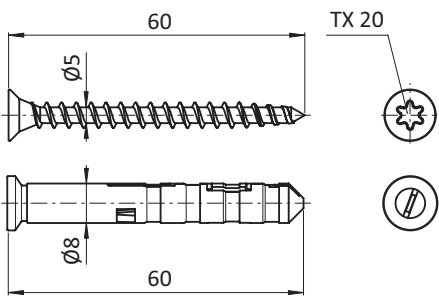

Weight [g]

88.0

Part #

02082FS

CONNECTING ELEMENT FOR GUIDING RAIL FIFO (SET)

MODEL	Stainless steel
DESCRIPTION	For parallel connection of two guiding rails FIFO, as spacer for aligning the track; To be screwed on infeed caps with enclosed screws
MATERIAL	Stainless steel
SURFACE	Plain
SET	2 connecting elements 8 screws DIN 7991 (ISO 10642) - M6 x 16
PACK QUANTITY	1 set
TIP	Compatible guiding rail FIFO see 02082P.1200 Compatible infeed cap for guiding rail FIFO (set) see 02082CCS01

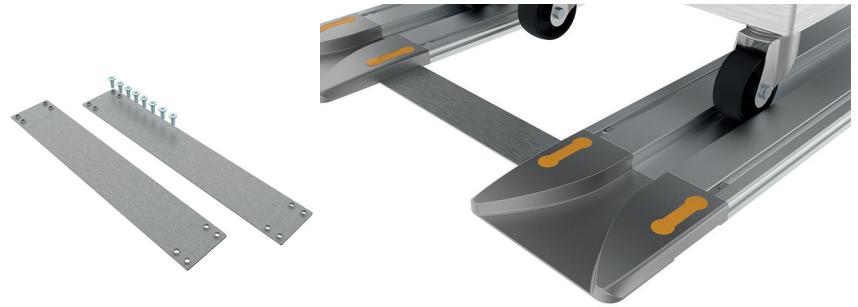
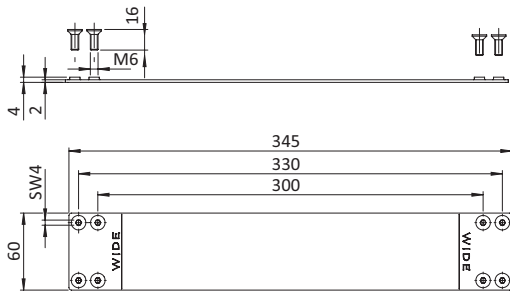

Weight [g]	Part #
692.2	02082D

CONNECTING STRIP 140 I, SLOT 8 (SET)

MODEL	Steel
DESCRIPTION	End-to-end connection of two aluminum profiles without machining
MATERIAL	Steel
SURFACE	Zinc plated
SET	1 connecting strip 140 - slot 8 4 screws DIN 914 - M8 x 10
PACK QUANTITY	10 set

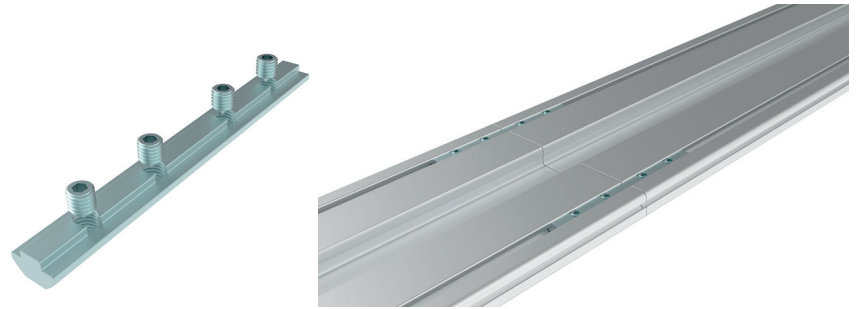
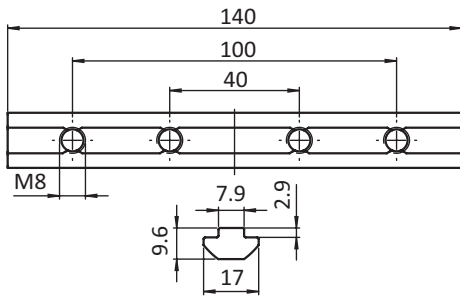

L [mm]	Slot	Size	Weight [g]	Profile	Part #
140.0	8	M8	121.0	I	096060S02

BRUSH BRAKE FOR GUIDING RAIL FIFO

MODEL	Aluminum, Slot 8
DESCRIPTION	for braking and stopping dollies in guiding rails; variable fixable via slot of the guide rail FIFO
MATERIAL	Body : Aluminum Bristles: Plastics PA
SURFACE	Body : Anodized
COLOR	Bristles: Black
DIMENSIONS	Total Length: 300 mm Length of the Bristles: 20 mm
PACK QUANTITY	1 piece
TIP	Compatible guiding rail FIFO see 02082P.1200

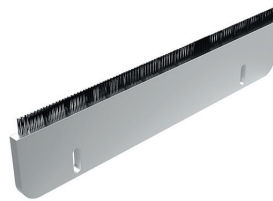
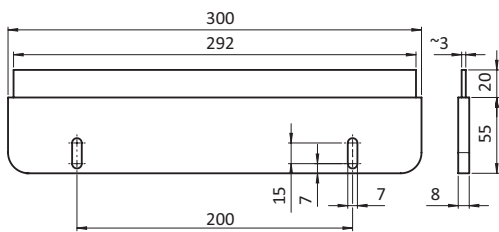

Weight [g]

149.38

Part #

02082BB

ADJUSTABLE CASTER END STOP FOR GUIDING RAIL FIFO (SET)

MODEL	Aluminum
DESCRIPTION	To stop dollies in guiding rails FIFO; Easy installation with enclosed connectors
MATERIAL	Profile: Aluminum Cover Cap: Plastic PA Connector: Steel
SURFACE	Profile: Anodized Connector: Zinc plated
COLOR	Cover caps: Gray ≈ RAL 7042
SET	1 profile piece 2 cover caps 2 connectors
PACK QUANTITY	1 set
TIP	Compatible guiding rail FIFO see 02082P.1200

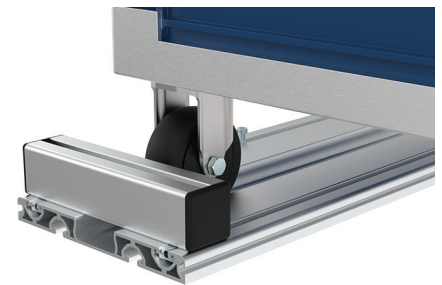
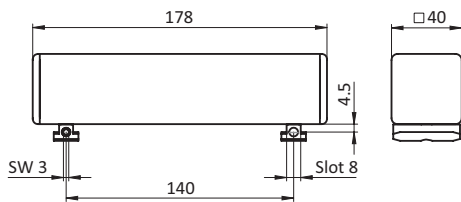

L [mm]	Weight [g]	Profile	Part #
178.0	380.0	I	02082ES

COVER PROFILE SLOT 8 - 4.5

MODEL	Plastic PP, slot 8
DESCRIPTION	To cover T-Slots with 8 mm width and a 4.5 mm profile web
MATERIAL	Plastic PP
COLOR	Black, yellow, gray, alu color
PACK QUANTITY	200 meters (100 pieces at 2 m)
SPECIALS	Other colors on request
TIP	Please note: You are ordering in meters!

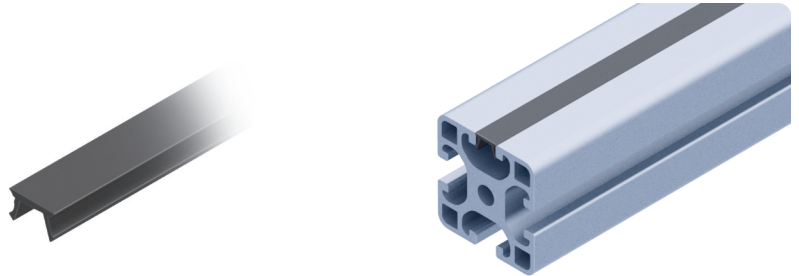
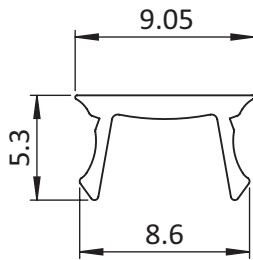

	ESD	Slot	Color	Weight [g/m]	Profile	Part #
		8	Black	16.0	I	092080
ESD electrostatical discharging		8	Black	16.0	I	092080S03
		8	Yellow ≈ RAL 1018	16.0	I	092081
		8	Gray ≈ RAL 7042	16.0	I	092080S02
		8	Alu color coated	16.0	I	092080A

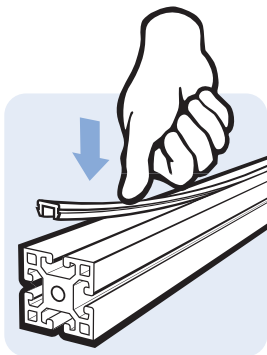

ANGLE CONNECTOR 40, 45°

MODEL	Zinc die-cast
DESCRIPTION	To connect two aluminum profiles at 45°
MATERIAL	Zinc die-cast
SURFACE	Plain / laquered
COLOR	Alu color
PACK QUANTITY	10 pieces
SPECIALS	Other surfaces, other colors on request

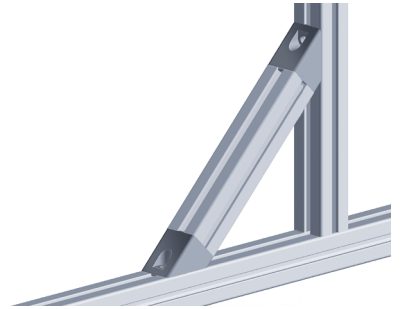
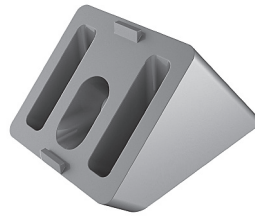
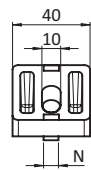
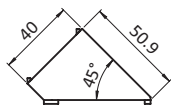
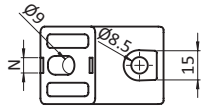

Version	N	for Screw	Weight [g]	Part #
Plain	8	M8	209.0	093WS40145N08R
Alu color	8	M8	214.0	093WS40145N08

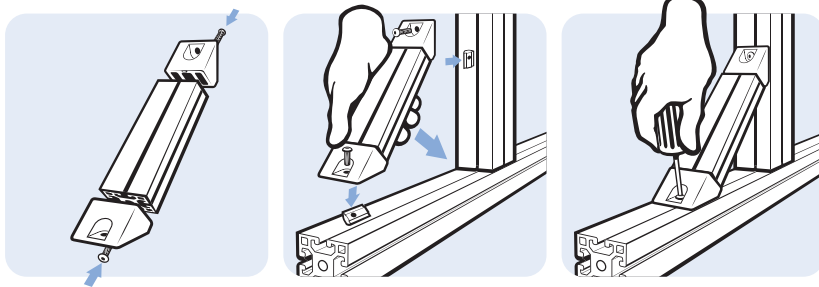

ANGLE CONNECTOR I 40, 45° (SET)

MODEL	Aluminum die-cast
DESCRIPTION	To connect two aluminum profiles at 45°
MATERIAL	Angle connector: Aluminum die-cast Centering pieces: Zinc die-cast Cover cap: Plastic PA, glass fiber reinforced
SURFACE	Angle connector: Laquered
COLOR	Angle connector: Alu color Cover cap: Gray ≈ RAL 7042
SET	1x angle connector, 4x centering pieces, 1x cover cap
PACK QUANTITY	10 set

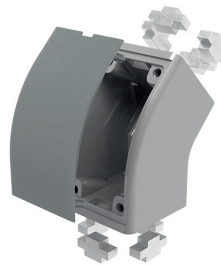
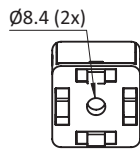
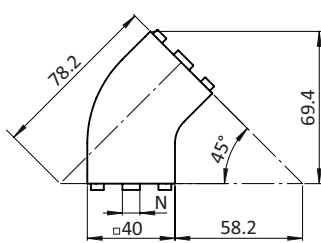

N	Weight [g]	Part #
8 / 10	138.0	093WS40545N08S01

AUTOMATIC CONNECTOR STEEL

MODEL	Steel
DESCRIPTION	To connect two aluminum profiles fast and solid, assembly without machining; self-cutting thread
MATERIAL	Steel
SURFACE	Zinc plated
PACK QUANTITY	10 / 100 pieces
TIP	* Compatible cover cap see 099GA081K
TIP 2	** Automatic connector with assembly set for profil B incl. hammer nut instead of T-slot nut

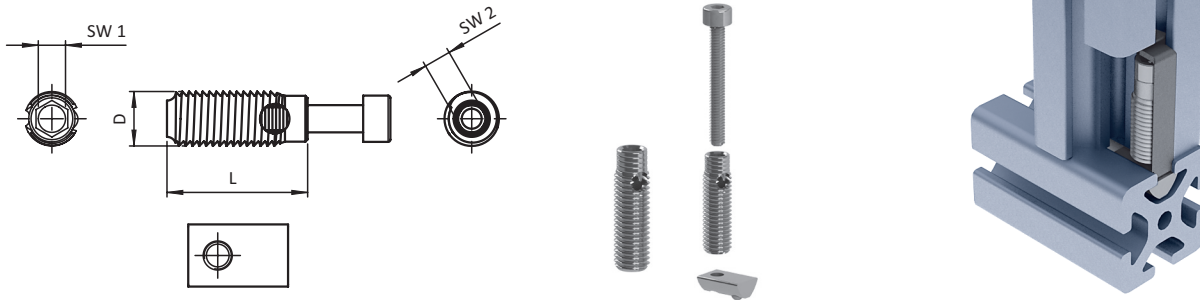

Version	D [mm]	L [mm]	Slot	Profile Width	Screw	SW 1	SW 2	Weight [g]	Profile	Tip	Part #
Cutting sleeve	12.0	31.0	8	40			6	13.0	I	*	099GS081
With assembly set, incl. screw and T-slot nut **	12.0	31.0	8	40	M6 x 40	5	6	33.0	I	*	099G081

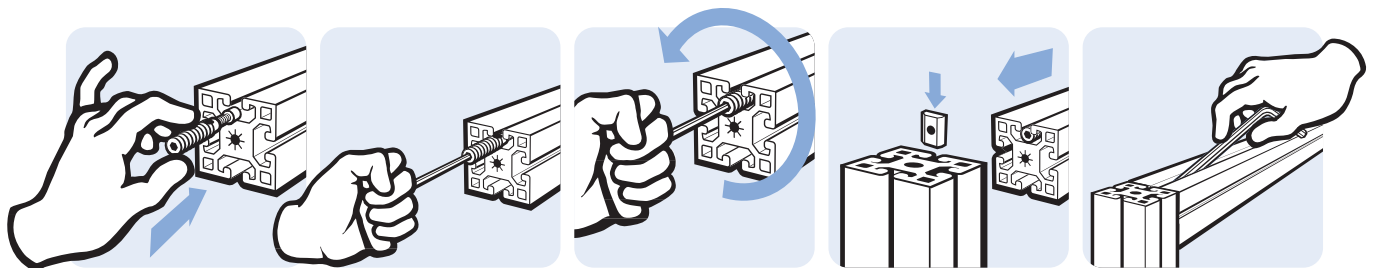

AUTOMATIC DOUBLE CONNECTOR I, SLOT 8 (SET)

MODEL	Steel
DESCRIPTION	To connect two aluminum profiles fast and solid, assembly without machining; self-cutting thread
MATERIAL	Steel
SURFACE	Zinc plated
PACK QUANTITY	100 pieces
TIP	* Compatible cover cap see 099GA081K



A [mm]	ESD	D [mm]	L [mm]	Slot	Profile Width	Screw	SW 1	SW 2	Weight [g]	Profile	Part #
26.4		12.0	31.0	8	40	M6 x 40	6	5	48.0	I	099G081D40
66.4		12.0	31.0	8	80	M6 x 40	6	5	62.0	I	099G081D80

MILLING CONNECTOR I, SLOT 8 (SET)

MODEL	Steel, slot 8
DESCRIPTION	To connect two aluminum profiles fast and solid; assembly without machining
MATERIAL	Steel
SET	1 milling connector, 1 screw DIN 912 - M5 x 18, 1 hammer nut
PACK QUANTITY	10 set

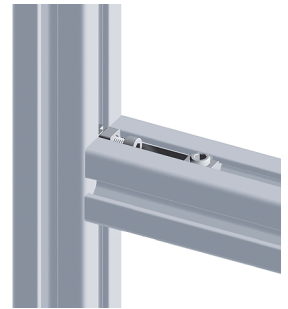
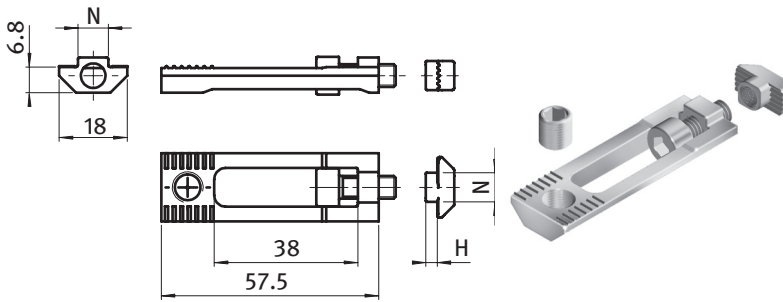

H [mm]	N	Weight [g]	Profile	Part #
3.0	8	37.3	I	099D0840M0530

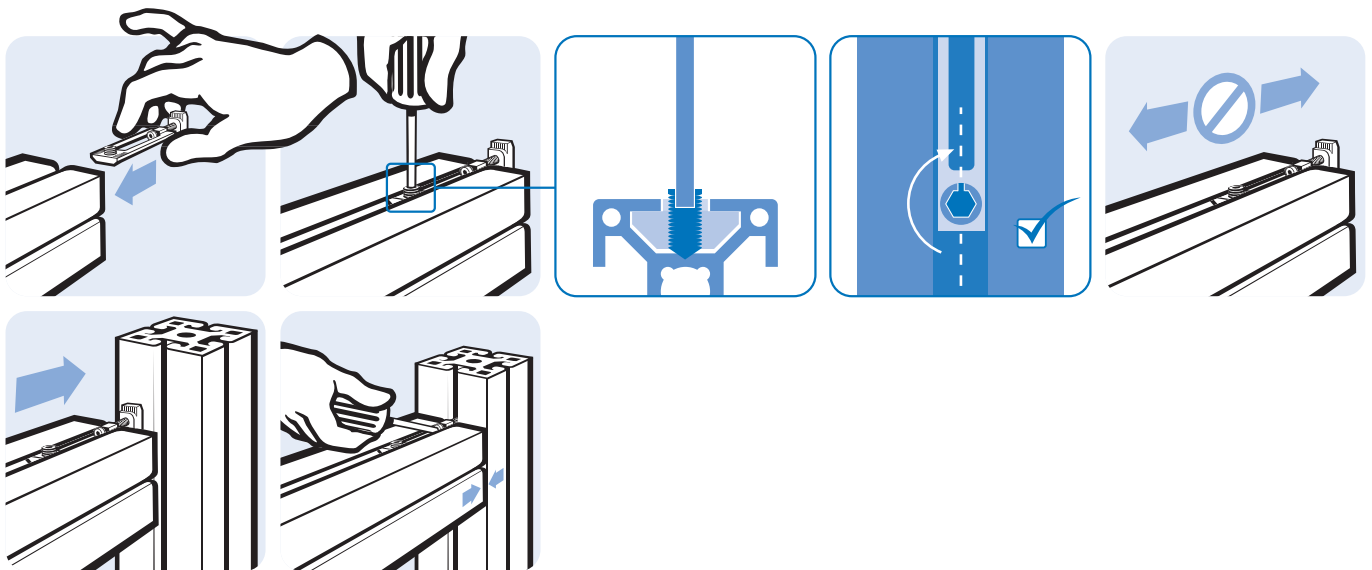
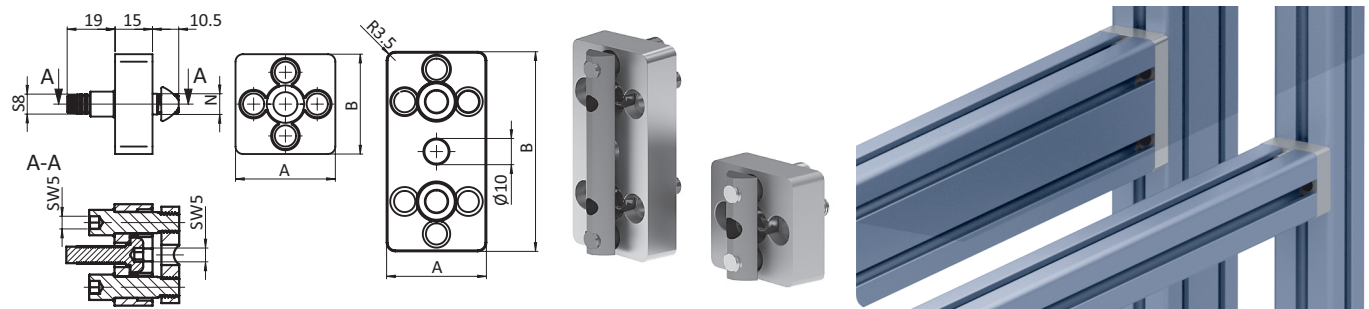

PLATE CONNECTOR I ZN 40 (SET)

MODEL	Zinc die-cast, slot 8
DESCRIPTION	To tee connect two aluminum profiles
MATERIAL	Plate Connector: Zinc die-cast Assembly set: Steel
SURFACE	Plate Connector: Plain / powder coated Assembly set: Zinc plated
COLOR	Alu color
SET 1	1 self-tapping screw SF7 x 25, 1 double T-slot nut - Nut 8 - M8, 2 shaft screws M8
SET 2	2 self-tapping screws SF7 x 25, 1 double T-slot nut - Nut 8 - M8, 2 shaft screws M8
SET 3	2 self-tapping screws SF7 x 25, 2 double T-slot nuts - Nut 8 - M8, 4 shaft screws M8
PACK QUANTITY	10 set



	Set	N	Surface	A x B [mm]	Weight [g]	Profile	Part #
	Set 1	8	Plain	40 x 40	134.0	I	099E40400808RS01
	Set 2	8	Plain	40 x 80	242.0	I	099E40800808RS01
	Set 3	8	Plain	40 x 80	266.0	I	099E40800808RS02
	Set 1	8	Alu color	40 x 40	134.0	I	099E40400808AS01
	Set 2	8	Alu color	40 x 80	242.0	I	099E40800808AS01
	Set 3	8	Alu color	40 x 80	266.0	I	099E40800808AS02

ZINC CONNECTION ANGLE 40 FLAT

MODEL	Zinc die-cast
DESCRIPTION	To connect two aluminum profiles or panels at right angles; the connection angle can be closed with the cover cap
MATERIAL	Angle: Zinc die-cast Cover cap: Plastic PA, glass fiber reinforced Assembly set: Steel
SURFACE	Angle: Plain / Powder coated Assembly set: Zinc plated
COLOR	Cover cap: Black, gray
ASSEMBLY SET	1 Cover cap - Plastic PA - black, 2 T-slot nuts - slot 8 - M8, 2 Screws ISO 7380 - M8 x 16
PACK QUANTITY	10 pieces / 10 set
SPECIALS	Other surfaces, other colors on request

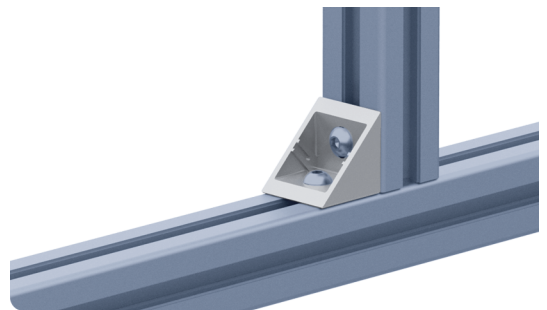
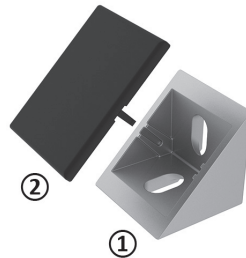
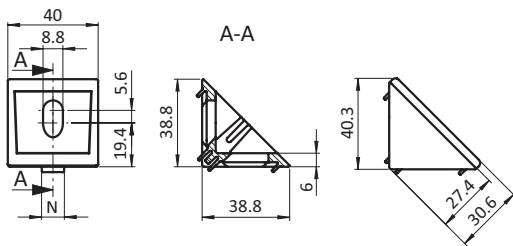
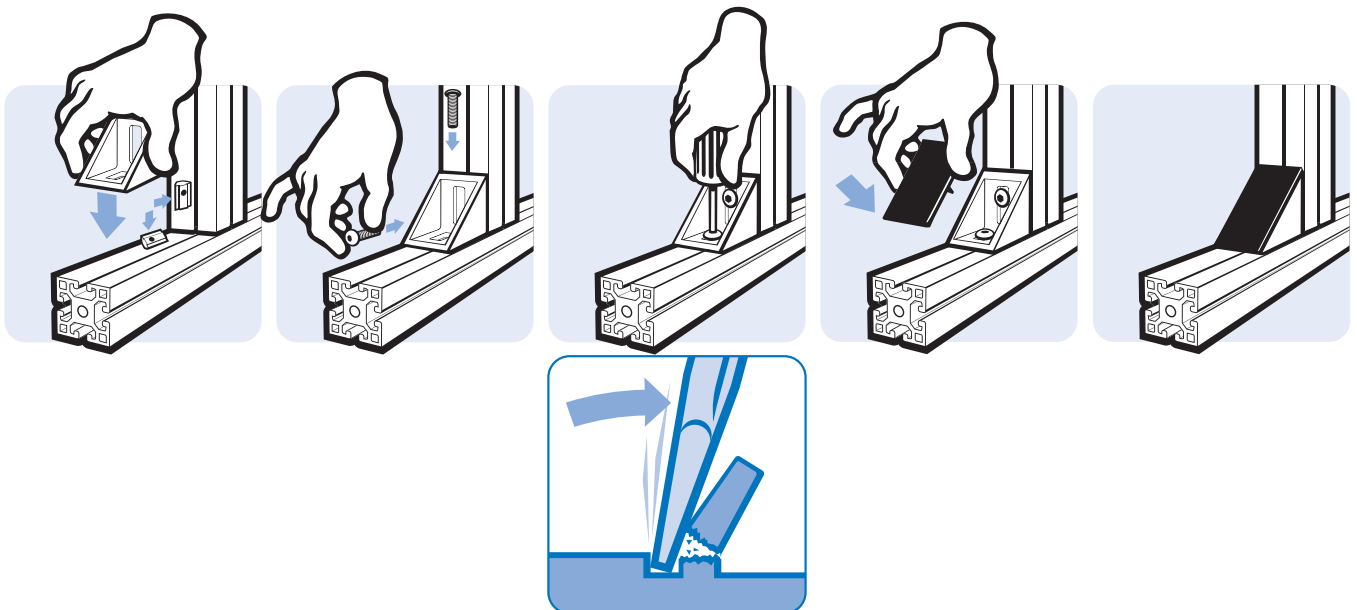

Fig.	Version	N	Weight [g]	Profile	Part #
①	Plain	8	84.0		093W401N08R
①	Alu color	8	88.0		093W401N08
②	Cover cap Black		8.0		093WA401
②	Cover cap Gray ≈ RAL 7042		8.0		093WA401S01
	Alu color with assembly set	8	135.5	I	093W401N08S03



ZINC CONNECTION ANGLE 40 / 80 FLAT

MODEL	Zinc die-cast
DESCRIPTION	To connect two aluminum profiles or panels at right angles; the connection angle can be closed with the cover cap
MATERIAL	Angle: Zinc die-cast Cover cap: Plastic PA, glass fiber reinforced Assembly set: Steel
SURFACE	Angle: Plain / Powder coated Assembly set: Zinc plated
COLOR	Cover cap: Black Angle: Alu color
ASSEMBLY SET	1 Cover cap - Plastic PA - black, 4 T-slot nuts - slot 8 - M8, 4 Screws ISO 7380 - M8 x 16
PACK QUANTITY	10 pieces / 10 set
SPECIALS	Other surfaces, other colors on request



Fig.	Version	N	Weight [g]	Profile	Part #
①	Plain	8	269.0		093W802N08R
①	Alu color	8	270.0		093W802N08
②	Cover cap		17.2		093WA802
	incl. assembly set	8	361.0	I	093W802N08S02

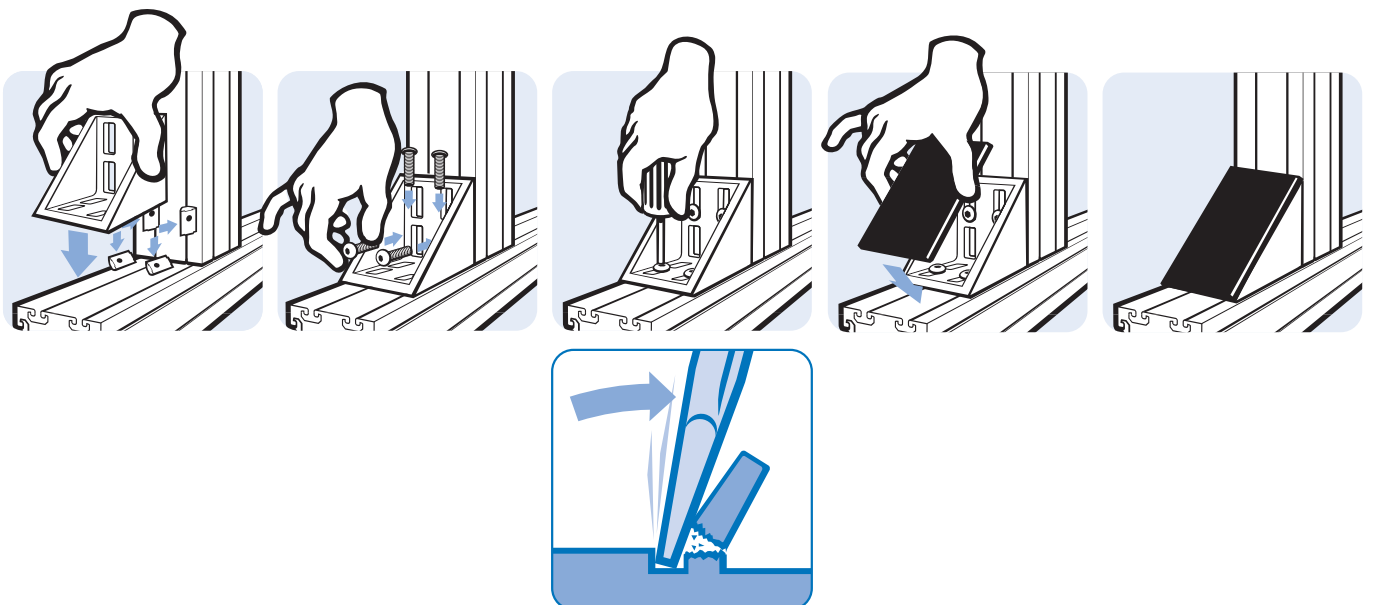

ALU CONNECTION ANGLE I40 M (SET)

MODEL	Aluminum die-cast
DESCRIPTION	To connect two aluminum profiles quickly at right angles, direct inserting into the profile slot thanks to correct positioning of the pre-assembled magnet rhombus screws and countersunk nuts; the connection angle can be closed with the cover cap
MATERIAL	Angle: Aluminum die-cast Cover cap: Plastic PA, glass fiber reinforced, Magnet rhombus screws: Steel Countersunk nuts: Steel
SURFACE	Angle: Lacquered Countersunk nuts: Zinc plated
COLOR	Cover cap: Black, gray
PACK QUANTITY	10 pieces
SPECIALS	Other surfaces, other colors on request



Version	Slot	Weight [g]	Profile	Part #
	8	98.0	I	093W406N08S01
Cover cap Black		10.0	I	093WA406
Cover cap Gray ≈ RAL 7042		10.0	I	093WA406S01

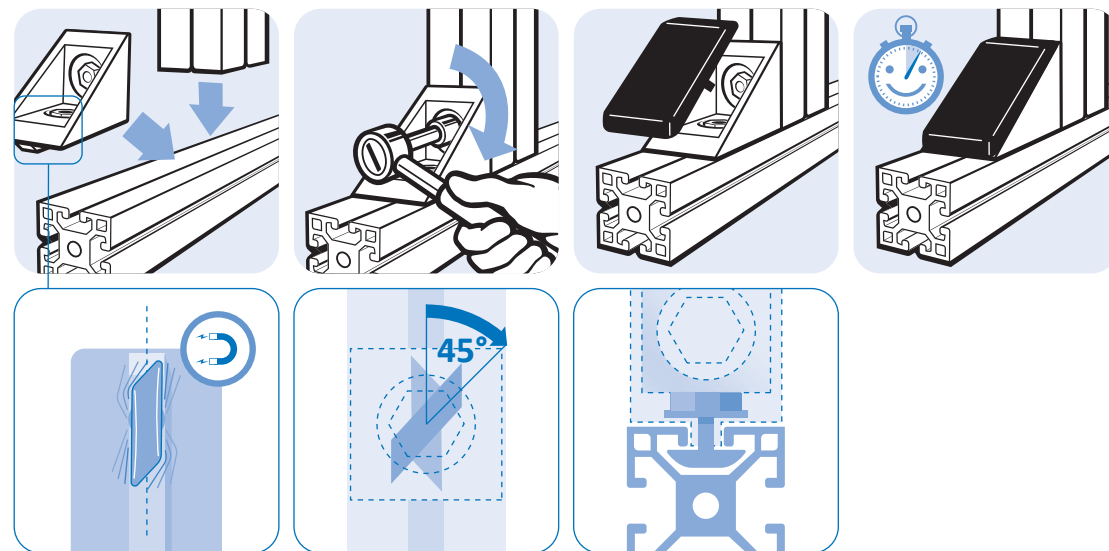

ALU CONNECTION ANGLE I40 X 80 M (SET)

MODEL	Aluminum die-cast
DESCRIPTION	To connect two aluminum profiles quickly at right angles, direct inserting into the profile slot thanks to correct positioning of the pre-assembled magnet rhombus screws and countersunk nuts; the connection angle can be closed with the cover cap
MATERIAL	Angle: Aluminum die-cast Cover cap: Plastic PA, glass fiber reinforced, Magnet rhombus screws: Steel Countersunk nuts: Steel
SURFACE	Angle: Lacquered Countersunk nuts: Zinc plated
COLOR	Cover cap: Black, gray
PACK QUANTITY	10 pieces
SPECIALS	Other surfaces, other colors on request



Version	Slot	Weight [g]	Profile	Part #
	8	197.0	I	093W809N08S01
Cover cap Black		21.0	I	093WA809
Cover cap Gray ≈ RAL 7042		21.0	I	093WA809S01

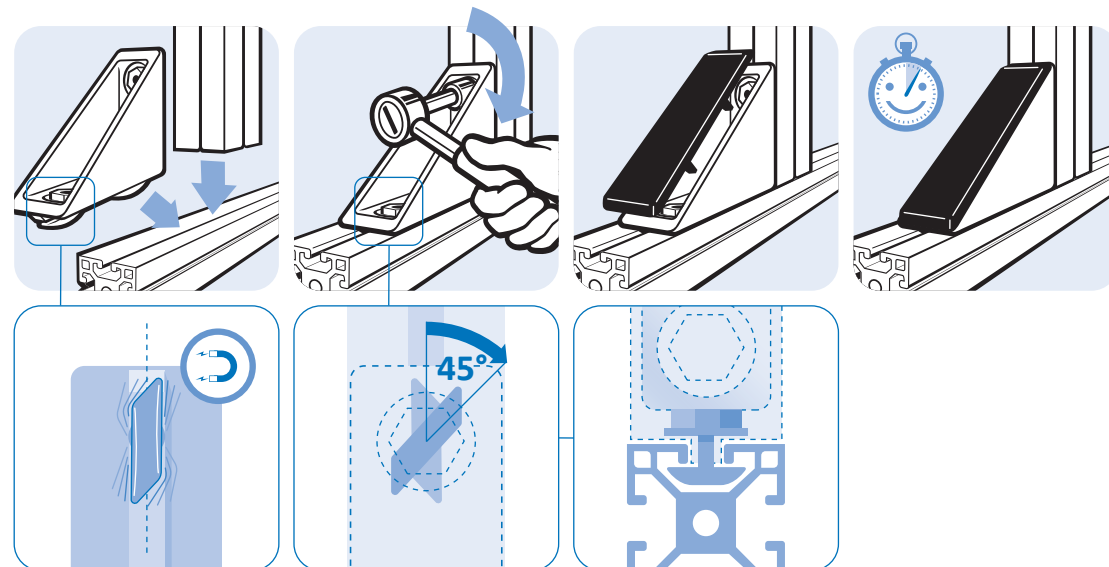

CONNECTION PLATE I40 M LENGTH/CROSS, RECTANGULAR 2 HOLE, 1 SLOT (SET)

MODEL	Aluminum die-cast
DESCRIPTION	To connect two aluminum profiles quickly at right angle or parallel, direct inserting into the profile slot thanks to lengthwise or crosswise positioning of the pre-assembled magnet rhombus screws and counter sunk nuts with the 90° turnable inserts; the open screwing holes of the connection plate can be closed with the cover caps
MATERIAL	Connection plate: Aluminum die-cast Cover Caps: Plastic PA, glass fiber reinforced Magnet rhombus screws: Steel Countersunk nuts: Steel
SURFACE	Connection plate: Laquered Magnet rhombus screws: Zinc plated Countersunk nuts: Zinc plated
COLOR	Connection plate: Alu color Cover Caps: Gray ≈ RAL 7042
SET	1 connection plate with pre-assembled magnet rhombus screws and counter sunk nuts in 90° turnable inserts 2 cover caps
PACK QUANTITY	10 set
SPECIALS	Other surfaces, other colors on request

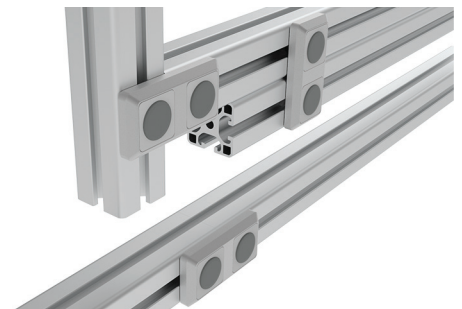
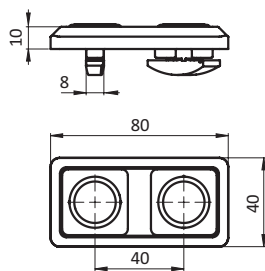

Slot	Weight [g]	Profile	Part #
8	111.1	I	093VM4080LN08

CONNECTION PLATE I120 M (SET)

MODEL	Aluminum die-cast
DESCRIPTION	To connect two aluminum profiles quickly at right angle, direct inserting into the profile slot thanks to correct positioning of the pre-assembled magnet rhombus screws and counter sunk nuts; the open screwing holes of the connection plate can be closed with the cover caps
MATERIAL	Connection plate: Aluminum die-cast Cover Caps: Plastic PA, glass fiber reinforced Magnet rhombus screws: Steel Countersunk nuts: Steel
SURFACE	Connection plate: Laquered Magnet rhombus screws: Zinc plated Countersunk nuts: Zinc plated
COLOR	Connection plate: Alu color Cover Caps: Gray ≈ RAL 7042
SET	1 connection plate with pre-assembled magnet rhombus screws and counter sunk nuts 4 cover caps
PACK QUANTITY	10 set
SPECIALS	Other surfaces, other colors on request

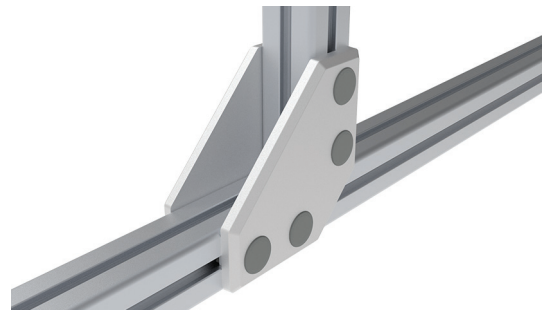
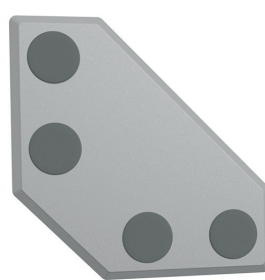
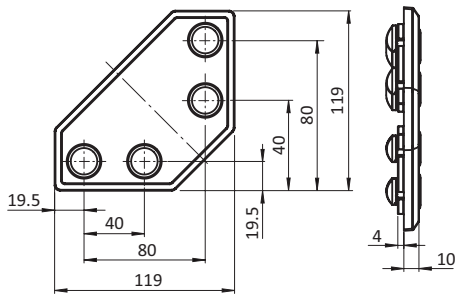

Slot	Weight [g]	Profile	Part #
8	331.6	I	093VM120120LN08

ROLL-IN T-SLOT NUT 13.5 X 7.2 MM WITH SPRING LOADED BALL

MODEL	Slot 8, self-aligning with spring loaded ball steel
DESCRIPTION	Self-aligning roll-in T-slot nut with spring loaded ball
MATERIAL	Steel SS304 / SS303
SURFACE	Zinc plated
PACK QUANTITY	100 pieces
SPECIALS	ESD electrostatical discharging, different lengths with multiple threads in different sizes available on request

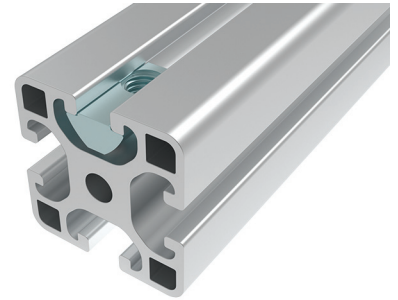
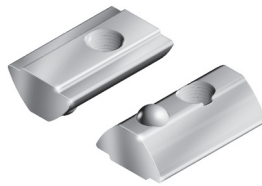
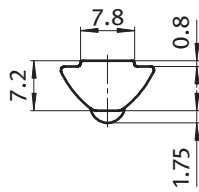
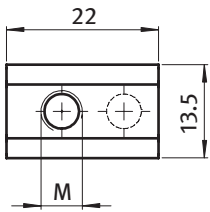

	Material	Size	Weight [g]	Profile	Part #
	Steel	M3	10.9	I	096023
	Steel	M4	10.8	I	096024
	Steel	M5	10.5	I	096025
	Steel	M6	9.9	I	096026
	Steel	M8	9.0	I	096028

FIFO MONORAIL RAIL 40

MODEL	Aluminum, anodized
DESCRIPTION	For guiding floor dollies on one side in FIFO stations, with a wheel width of up to 40 mm 2 slots at the top, set at 45°; closed back side for optional full-surface adhesion to the floor To extend two guiding rails, connect them face to face with connecting strip in the slots; posts can be mounted in the slot from above
MATERIAL	Aluminum
SURFACE	Anodized
PACK QUANTITY	1 set (= 4 pieces)
TIP	Compatible connecting strip see 096060S20 Compatible infeed cap for FIFO monorail rail (set) see 2082CCS02 Compatible monorail angle connector for post see 093WS30145S01 Compatible mounting set for posts support struts see 93WS30145S02 Compatible cover profiles see 092080

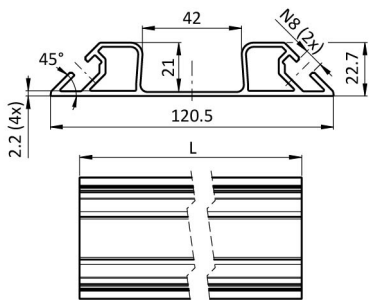

	L [mm]	Weight [g]	Profile	Part #
	1200.0	6996.0	B	02082PO.1200
	1800.0	10492.0	B	02082PO.1800
	2400.0	13988.0	B	02082PO.2400

INFEEED CAP FOR FIFO MONORAIL RAIL 40 (SET)

MODEL	Aluminum die-cast
DESCRIPTION	For easier loading and unloading of FIFO stations with floor dollies; Robust design, mounting directly in the slot of FIFO monorail rail 40 with enclosed hexagon socket set screws
MATERIAL	Infeed caps: Aluminum die-cast Hexagon socket set screws: Steel
SURFACE	Infeed caps: Powder coated Hexagon socket set screws: Zinc plated
COLOR	Infeed caps: Black
SET	8 infeed caps 16 hexagon socket set screws ISO 4027 - M6 x 8
FASTENING	From the front, using M6 countersunk screws
PACK QUANTITY	1 set
TIP	Compatible FIFO monorail rail 40 see 02082PO.1200

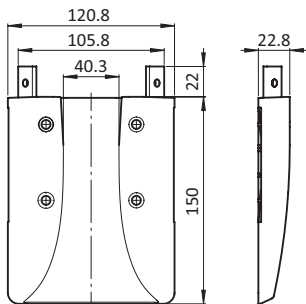

Weight [g]

Part #

2.041

02082CCS02

CONNECTING STRIP 180 B, SLOT 8

MODEL	Zinc plated
DESCRIPTION	End-to-end connection of two aluminum profiles without machining
MATERIAL	Steel
SURFACE	Zinc plated
SET	1 connecting strip 180, Slot 8, 4 screws DIN 912 - M6 x 12, 4 washers DIN 7349 - 6.4
PACK QUANTITY	10 set

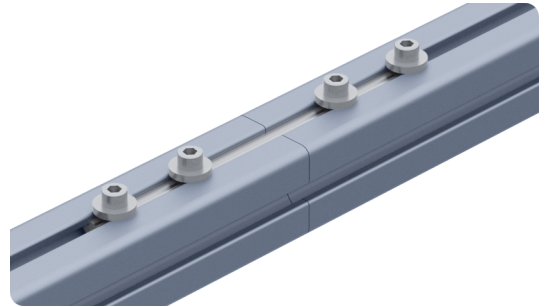
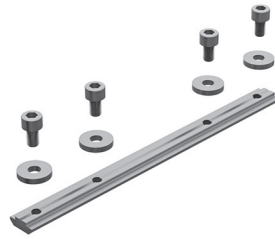
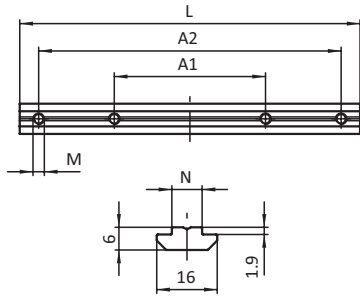

L [mm]	N	Size	A1 [mm]	A2 [mm]	Weight [g]	Profile	Part #
180.0	8	M6	80.0	160.0	134.0	B	096010S11

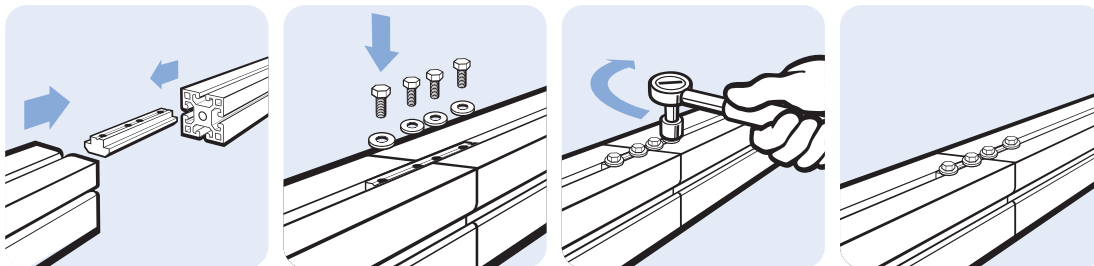

COVER PROFILE SLOT 8 - 2.2

MODEL	Plastic PP, slot 8
DESCRIPTION	To cover T-Slots with 8 width and a 2.2 mm profile web
MATERIAL	Plastic PP
COLOR	Black, yellow, red, blue, gray, aluminum color
PACK QUANTITY	200 meters (100 pieces at 2m)
SPECIALS	Other colors on request
TIP	Please note: You are ordering in meters!
TIP 2	ESD electrostatically discharging version: Notch at the bottom side

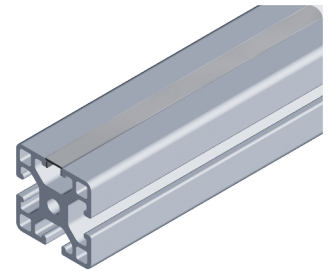
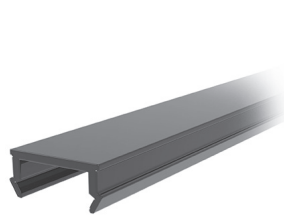
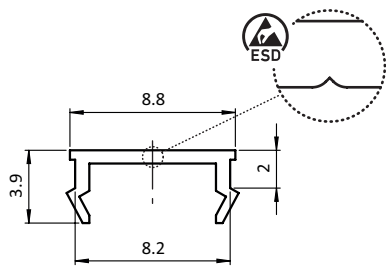

	ESD	Slot	Color	Weight [g/m]	Profile	Part #
		8	Black	10.0	B	092050
ESD electrostatical discharging		8	Black	10.0	B	092050S12
		8	Yellow ≈ RAL 1018	10.0	B	092054
		8	Red ≈ RAL 3020	10.0	B	092050S07
		8	Gray ≈ RAL 7004	10.0	B	092050S14
		8	Alu color coated	10.0	B	092050A
ESD electrostatical discharging		8	Alu color coated	10.0	B	092050AS01

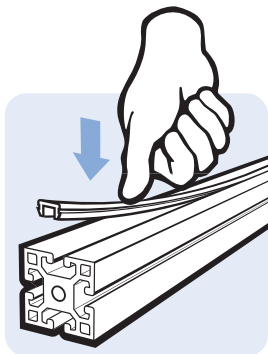

MONORAIL ANGLE CONNECTOR FOR POSTS (SET)

MODEL	For FIFO monorail rail 40
DESCRIPTION	To mount posts in the upper slot of FIFO monorail rail 40
MATERIAL	Aluminum
SET	2x angle connector 45° 30 x 30, 2x screws DIN EN ISO 4762 (DIN 912) - M8 x 12, 2x T-slot nuts - M8, 2x self-tapping screws - S8 x 25
PACK QUANTITY	1 set
TIP	Compatible FIFO monorail rail see 02082PO.1200

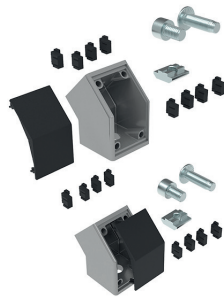
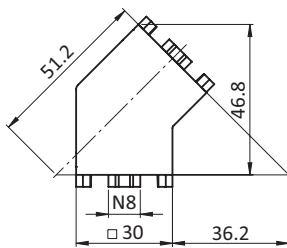

Slot	Weight [g]	Part #
8	150.0	093WS30145S01

MONORAIL ANGLE CONNECTOR FOR POST SUPPORT STRUTS (SET)

MODEL	For FIFO monorail rail 40
DESCRIPTION	For mounting diagonal struts to support posts in the upper slot of FIFO monorail rails 40
MATERIAL	Aluminum
SET	4x angle connector 45° 30 x 30, 2x screws DIN EN ISO 4762 (DIN 912) - M8 x 12, 2x T-slot nuts- M8, 2x self-tapping screws - S8 x 25, 2x screws DIN EN ISO 4762 (DIN 912) - M8 x 14, 2x hexagon nuts DIN EN ISO4035 (DIN 439) - M8
PACK QUANTITY	1 set
TIP	Compatible FIFO monorail rail see 02082PO.1200

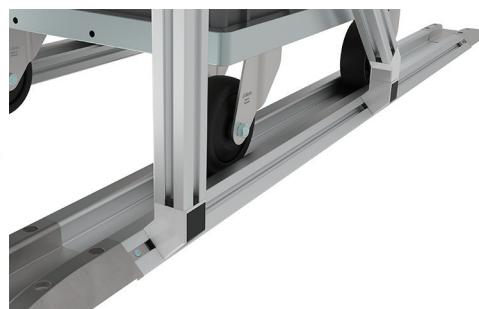
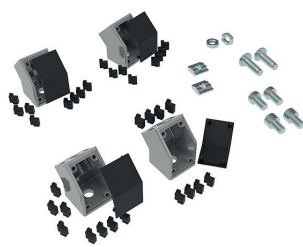
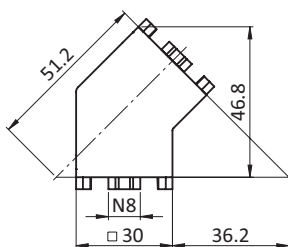

Slot	Dimensions	Weight [g]	Part #
8	30 x 30 x 45°	365.0	093WS30145S02

AUTOMATIC CONNECTOR STEEL

MODEL	Steel
DESCRIPTION	To connect two aluminum profiles fast and solid, assembly without machining; self-cutting thread
MATERIAL	Steel
SURFACE	Zinc plated
PACK QUANTITY	10 / 100 pieces
TIP	Automatic connector with assembly set for profil B incl. hammer nut instead of T-slot nut

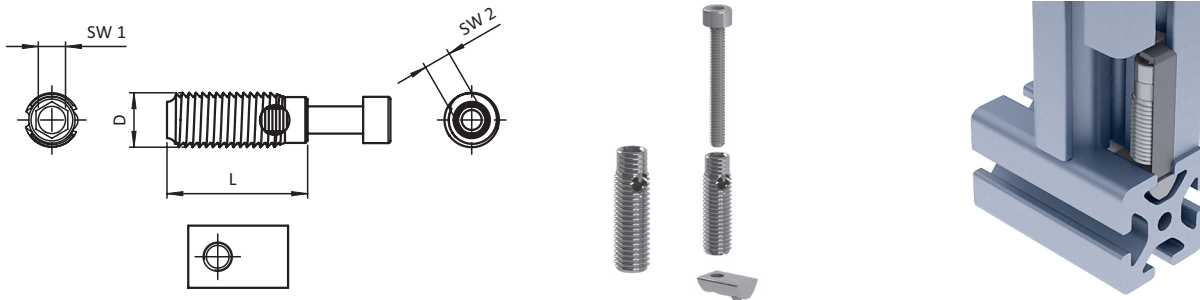

Version	D [mm]	L [mm]	Slot	Profile Width	Screw	SW 1	SW 2	Weight [g]	Profile	Part #
Cutting sleeve	10.7	24.0	8	30			5	7.5	B	099GS084
With assembly set, incl. screw and T-slot nut	10.7	24.0	8	30	M5 x 30	4	5	16.5	B	099G084

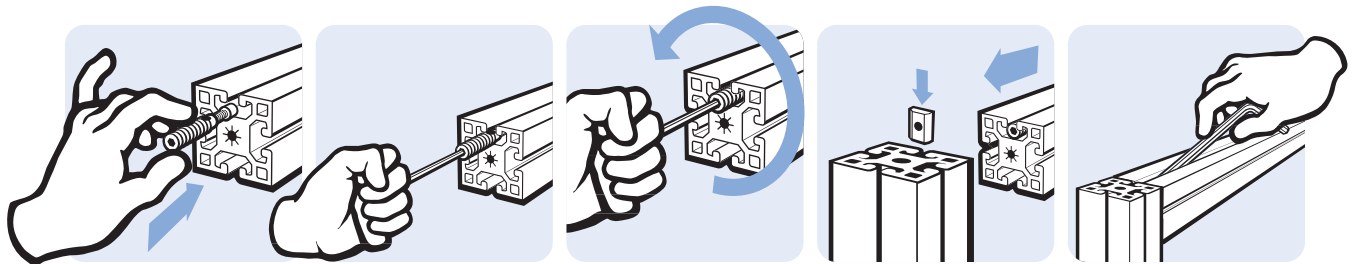

MILLING CONNECTOR B, SLOT 8

MODEL	Steel, slot 8
DESCRIPTION	To connect two aluminum profiles fast and solid; assembly without machining
MATERIAL	Steel
SET	1 milling connector, 1 screw DIN 912 - M5 x 14, 1 hammer nut
PACK QUANTITY	10 set

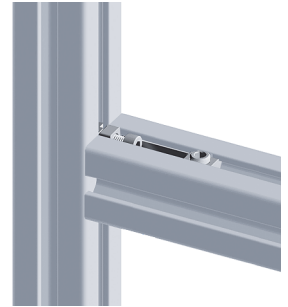
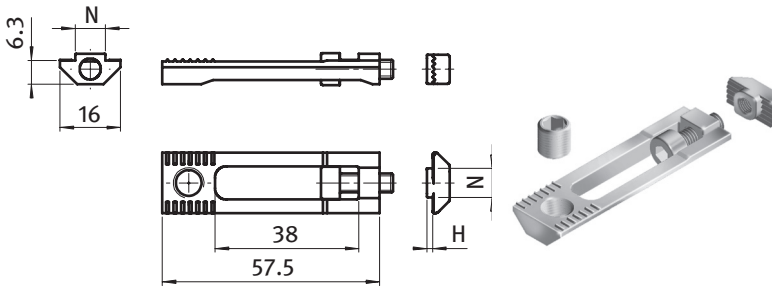

H [mm]	N	Weight [g]	Profile	Part #
1.5	8	31.7	B	099D0830M0515

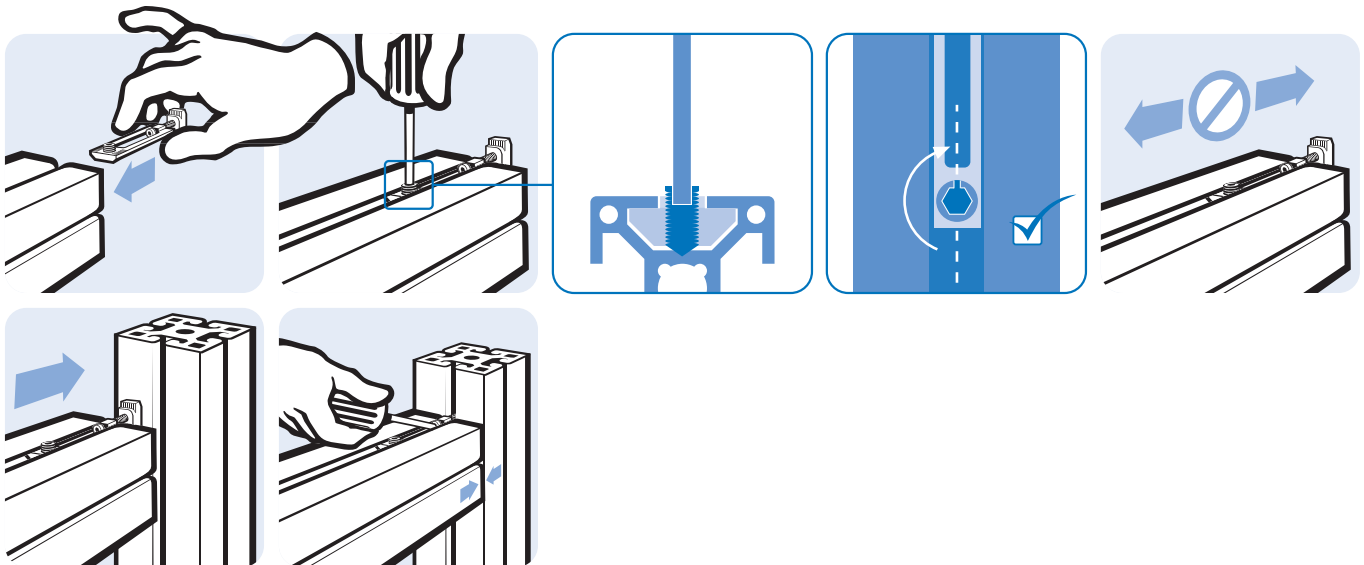
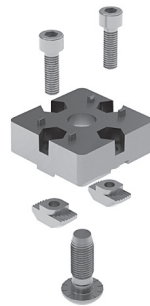
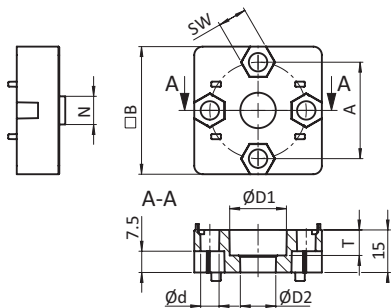
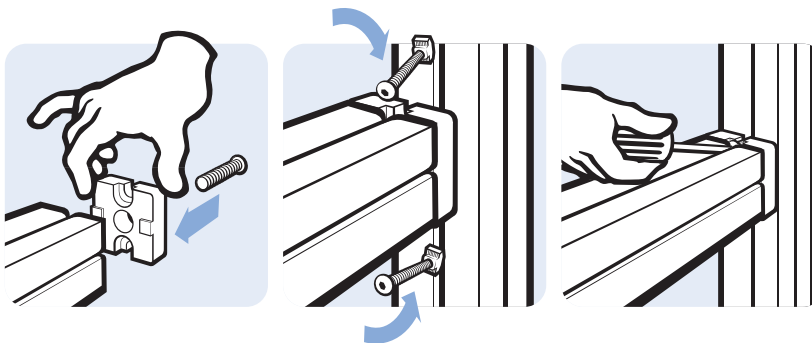

PLATE CONNECTOR B AL (SET)

MODEL	Aluminum die-cast
DESCRIPTION	To tee connect two aluminum profiles
MATERIAL	Plate connector: Aluminum die-cast Assembly set: Steel
SURFACE	Plate connector: Plain / laquered Assembly set: Zinc plated
COLOR	Alu color
ASSEMBLY SET 1	1 screw DIN 7984 - M8 x 30, 2 screws DIN 7984 - M5 x 16, 2 hammer nuts - slot 8 - M5
ASSEMBLY SET 2	1 self forming screw S12 x 30 Torx T50, 2 screws DIN 7984 - M6 x 20, 2 hammer nuts - slot 10 - M6
PACK QUANTITY	10 pieces / 10 set
SPECIALS	Other surfaces on request



Version	A [mm]	B [mm]	d [mm]	T [mm]	SW [mm]	N	D1 [mm]	D2 [mm]	Weight [g]	Profile	Part #
Plain, with assembly set 1	21.6	30	5.5	6.0	8.9	8	13.6	8.5	52.0	B	099EA30300808RS01
Alu Color, with assembly set 1	21.6	30	5.5	6.0	8.9	8	13.6	8.5	52.0	B	099EA30300808AS01



ALU CONNECTION ANGLE 30

MODEL	Aluminum die-cast, profile 30 and up
DESCRIPTION	To connect two aluminum profiles or panels at right angles; the connection angle can be closed with the cover cap
MATERIAL	Angle: Aluminum die-cast Cover Cap: Plastic PA, glass fiber reinforced Centering piece: Nylon PA, glass fiber reinforced Assembly set: Steel
SURFACE	Angle: Plain / Powder coated Assembly set: Zinc plated
COLOR	Cover cap: Black Centering piece: Black
ASSEMBLY SET 1	2 hammer nuts - slot 8 - M6, 2 screws DIN 7984 - M6 x 14
ASSEMBLY SET 2	1 hammer nut - slot 8 - M6, 1 screw DIN 7984 - M6 x 14, 1 hammer nut - slot 10 - M6, 1 screw DIN 7984 - M6 x 18, 2 Centering pieces - slot 8 to slot 10
ASSEMBLY SET 3	2 hammer nuts - slot 10 - M6, 2 screws DIN 7984 - M6 x 18, 4 Centering piece - slot 8 to slot 10
ASSEMBLY SET 4	2 hammer nuts - slot 8 - M6, 2 screws DIN 7984 - M6 x 14, 2 screws DIN 912 - M6 x 14
PACK QUANTITY	10 pieces / 10 set
SPECIALS	Other surfaces, other colors on request
TIP	* By means of two plastic adapters slot 8 to slot 10

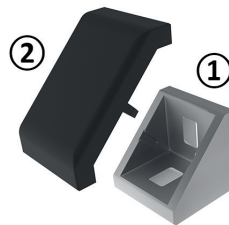
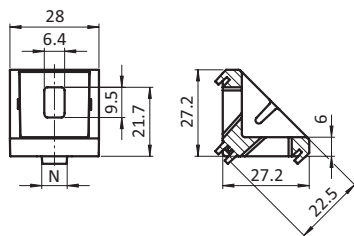
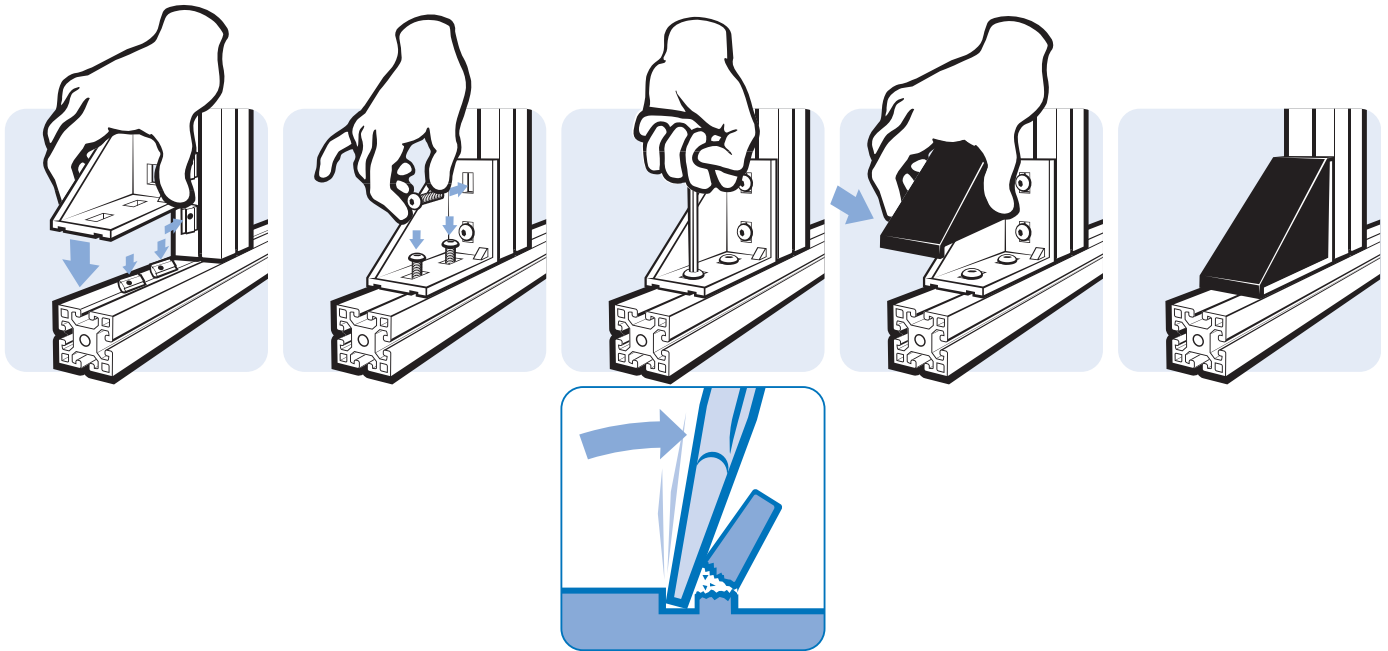

Fig.	Version	Slot	Weight [g]	Profile	Part #
①	Plain		19.8		093W303
①	Plain	8	20.6		093W303N08
①	Alu color	8	20.6		093W303N08S12
③	Centering piece	slot 8 to slot 10	1.0		093W02
②	Cover cap		5.2		093WA303S02
	Plain, with assembly set 1	8	35.0	B	093W303N08S11
	Plain, with assembly set 2	8 / 10	40.0	B	093W303N08S09
	Alu Color, with assembly set 4	8	48.0	B	093W303N08S13
	Alu Color, with assembly set 2	8 / 10	38.0	B	093W303N08S14



ALU CONNECTION ANGLE 30



ALU CONNECTION ANGLE 30 X 60

MODEL	Aluminum die-cast, profile 30 and up
DESCRIPTION	To connect two aluminum profiles or panels at right angles; the connection angle can be closed with the cover cap
MATERIAL	Angle: Aluminum die-cast Cover Cap: Plastic PA, glass fiber reinforced Centering piece: Nylon PA, glass fiber reinforced Assembly set: Steel
SURFACE	Angle: Plain / Powder coated Assembly set: Zinc plated
COLOR	Cover cap: Black Centering piece: Black
ASSEMBLY SET	4 hammer nuts - slot 8 - M6, 4 screws DIN 7984 - M6 x 14
PACK QUANTITY	10 pieces / 10 set
SPECIALS	Other surfaces, other colors on request

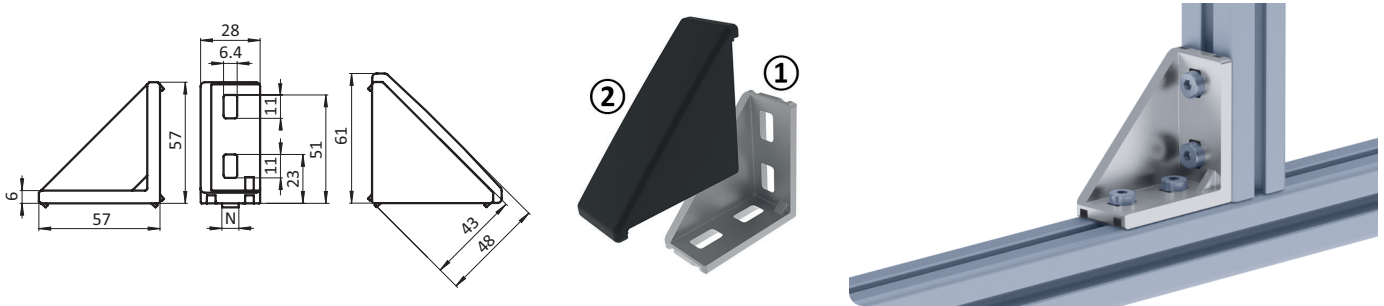
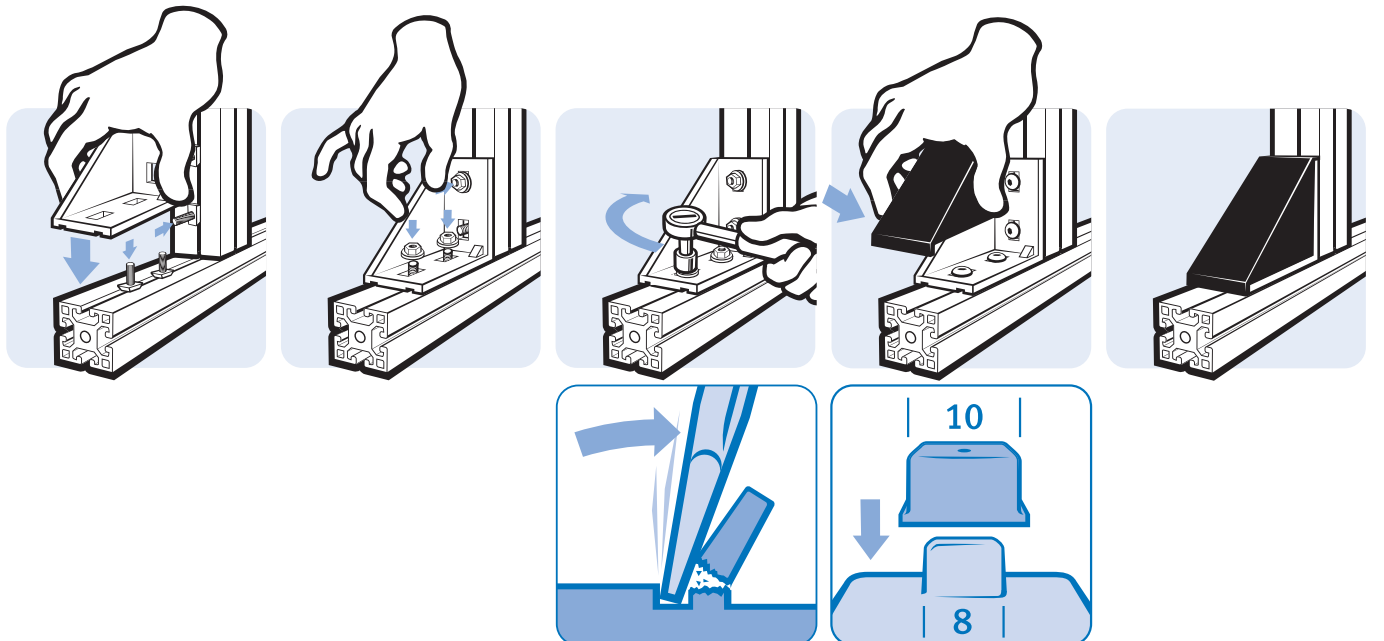
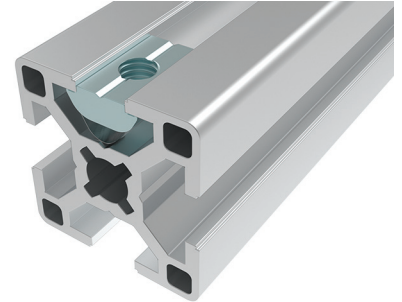
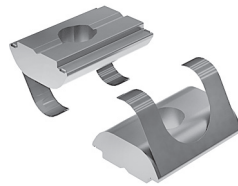
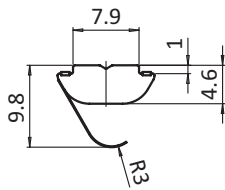
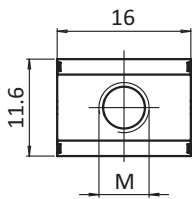

Fig.	Version	N	Weight [g]	Profile	Part #
①	Plain		60.0		093W302
①	Plain	8	58.5		093W302N08
①	Alu color	8	58.6		093W302N08S04
③	Centering piece	slot 8 to slot 10	1.0		093W02
②	Cover cap		14.0		093WA302
	Plain, with assembly set	8	82.0	B	093W302N08S01
	Alu Color, with assembly set	8	85.0	B	093W302N08S05



ROLL-IN T-SLOT NUT 11.6 X 4.6 MM WITH SPRING LEAF

MODEL	Slot 8, Self-aligning with Spring Leaf, Steel
DESCRIPTION	Self-aligning roll-in T-slot nut with spring leaf, ESD electrostatical discharging
MATERIAL	Steel
SURFACE	Zinc plated
PACK QUANTITY	100 pieces
SPECIALS	Different lengths with multiple threads in different sizes available on request



	Material	Size	Weight [g]	Profile	Part #
	Steel	M4	4.8	B	096314F
		M5	4.7	B	096315F
		M6	4.4	B	096316F
		M8	3.6	B	096318F

OUTER T-CONNECTOR D30 - SLOT 8 (SET)

MODEL	For tubular frame profiles
DESCRIPTION	To connect a tubular frame profile with \varnothing 30 mm outer diameter with a slot 8 aluminum profile
MATERIAL	Connector: Aluminum die-cast Adapter plate: Aluminum die-cast Assembly set: Steel
SURFACE	Assembly set: Zinc plated
SET	2 components for T-connector D30 1 adapter plate 1 screw DIN EN ISO 4762 (DIN 912) - M6 x 28 1 self locking nut ISO10511 - M6
FASTENING	On profile I - slot 8 - using screw ISO 7380 - M6 x 14
PACK QUANTITY	10 set
TIP	Compatible cover cap for tubular frame connectors D30 see 099RV30CC06

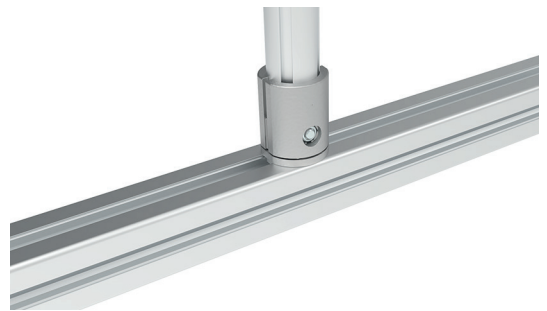
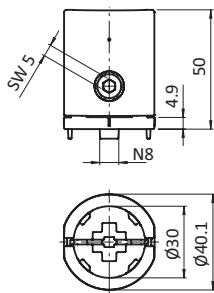

ESD	Weight [g]	Profile	Part #
ESD electrostatical discharging	109.0	I	099RV3090LS02

T-CONNECTOR PLATE D28

MODEL	For tubular frame profiles
DESCRIPTION	To connect a tubular frame profile with \varnothing 28 mm outer diameter with an aluminum profile at right angles; screw connection to the core hole of the \varnothing 28 mm profile or to the threaded sleeve for D28 M8 for \varnothing 28 mm tubular profiles
MATERIAL	Steel
SURFACE	Zinc plated
FASTENING	With countersunk screws 1x M8 and 2x M6
PACK QUANTITY	10 pieces
TIP	Compatible threaded sleeve D28 M8 see 099RV28AS02

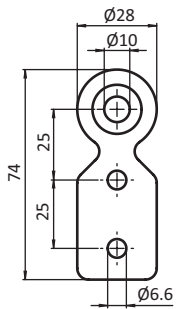

Weight [g]

Part #

52.3

093VAD28V

T-CONNECTOR PLATE D30 (SET)

MODEL	For tubular frame profiles
DESCRIPTION	To connect a tubular frame profile with \varnothing 30 mm outer diameter with an aluminum profile at right angles; screw connection to the core hole M6 of the tubular frame profile \varnothing 30 mm or to the threaded sleeve AL D30 M6 for tubular frame profiles
MATERIAL	Steel
SURFACE	Zinc plated
SET 1	1 T-connector plate, 2 T-slot nuts - slot 6 - M6, 2 screws DIN 7991 - M6 x 12, 1 screw DIN 7991 - M6 x 20
SET 2	1 T-connector plate, 1 double T-slot nut - slot 8 - 2x M6, 2 screws DIN 7991 - M6 x 14, 1 screw DIN 7991 - M6 x 20
PACK QUANTITY	10 set

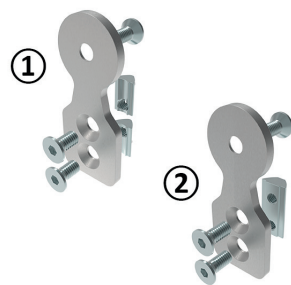
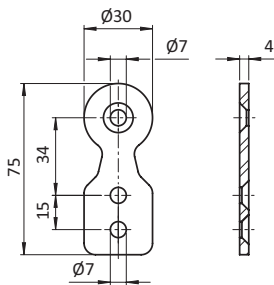
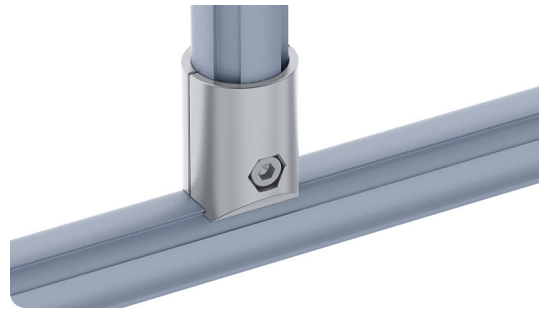
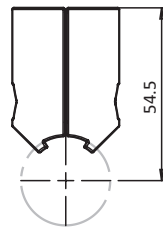
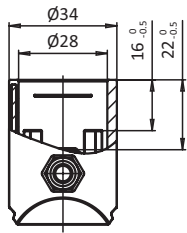

Fig.	Set	Slot	Weight [g]	Profile	Part #
①	Set 1	6	69.0	I	093VAD30VS01
②	Set 2	8	71.0	I	093VAD30V

OUTER T-CONNECTOR D28 (SET)

MODEL	For tubular frame profiles
DESCRIPTION	To connect two tubular frame profiles with \varnothing 28 mm outer diameter at right angles
MATERIAL	Connector: Aluminum die-cast Assembly set: Steel
SURFACE	Connector: Plain Assembly set: Zinc plated
SET	2 components for T-connector D28, 1 screw DIN 912 - M6 x 25, 1 self-locking nut ISO 10511 - M6
PACK QUANTITY	10 sets



	ESD	Weight [g]	Part #
	ESD electrostatical discharging	56.0	099RV2890LS01

ADAPTER PLATE D28 (SET)

MODEL	For tubular frame profiles
DESCRIPTION	To connect tubular frame profiles with slot 8 or 10 aluminum profiles
MATERIAL	Adapter plates: Aluminum die-cast Centering piece: Zinc die-cast
SURFACE	Plain
SET	1 adapter plate, 2 locating pins for slot 8 and 10
FASTENING	with pan-head-screw ISO 7380 - M8
PACK QUANTITY	10 set
TIP	Compatible connector see 099RV2890LS01, 099RV28KS01, 099RV2845S01 - 099RV2890QS01 * Compatible cutting bush for the reduction of the Ø 10.2 mm core hole to thread size M8 see 09308801

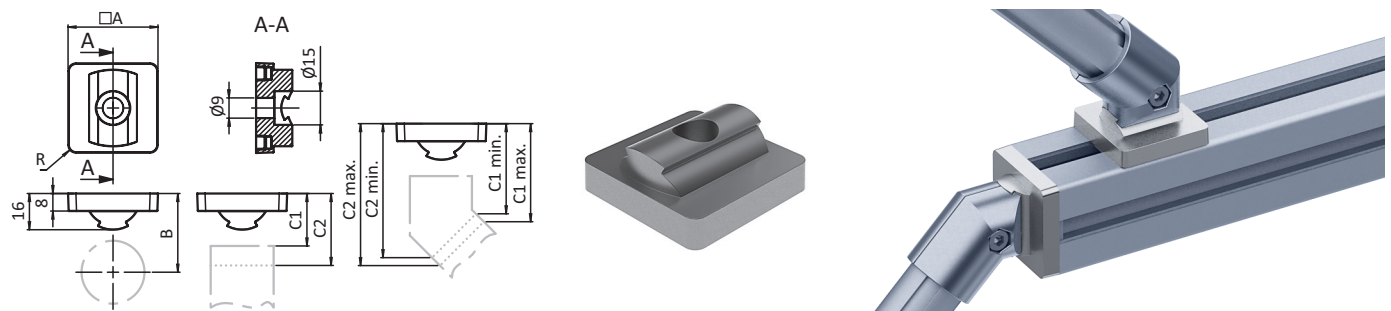

A [mm]	ESD	R [mm]	Slot	Weight [g]	Part #
40.0	ESD electrostatical discharging	4.0	8 / 10	29.0	099RVAP40S01
45.0	ESD electrostatical discharging	3.0	8 / 10	33.0	099RVAP45S01

ROLLER TRACK XST R28

MODEL	Assembled ready for use
DESCRIPTION	Economical, resilient and smooth running roller track XST R28
MATERIAL	Roller track profile XST: Steel Standard roller: Plastic PP ESD electrostatically discharging roller: Plastic PP, electrostatically discharging Axle: Steel
COLOR	Black, gray
PACK QUANTITY	12 pieces at 2000 mm
SPECIALS	Other colors on request

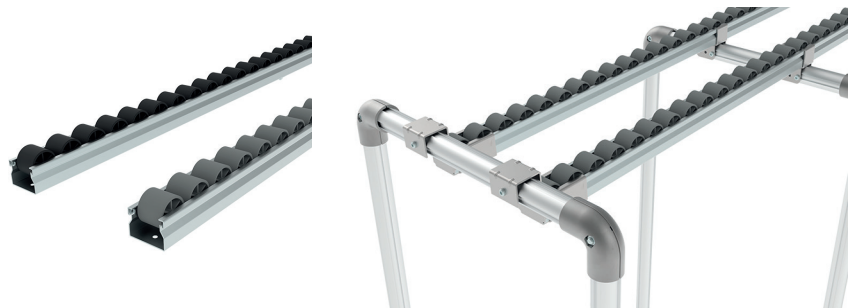
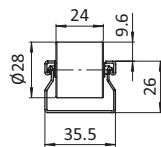
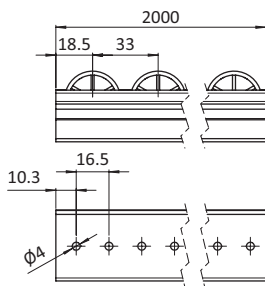

ESD	Color of Roller	Weight [g/m]	Part #
	Gray ≈ RAL 7042	823.0	6XPR2872.2000
ESD	Black	886.0	6XPR2891ESD.2000

ROLLER TRACK XST R28 MIT SPURKRANZ

MODEL	Assembled ready for use
DESCRIPTION	Economical, resilient and smooth running roller track XST R28, with flange as lateral guiding
MATERIAL	Roller track profile XST: Steel Standard roller: Plastic PP ESD electrostatically discharging roller: Plastic PP, electrostatically discharging Axle: Steel
COLOR	Black, gray
PACK QUANTITY	12 pieces at 2000 mm
SPECIALS	Other colors on request

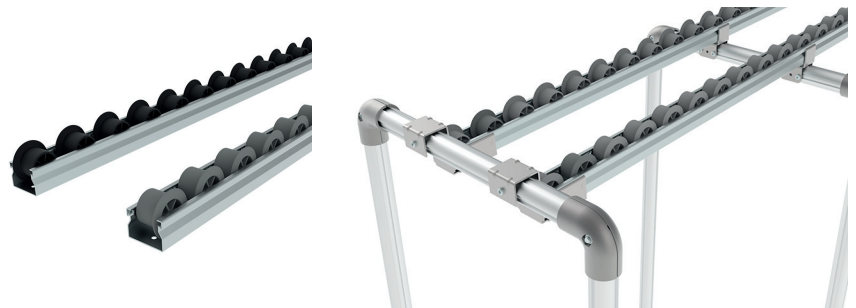
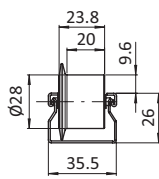
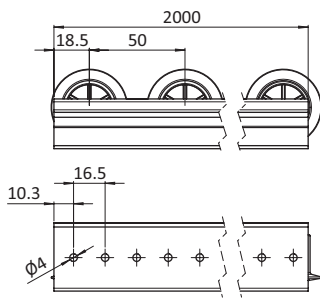

ESD	Color of Roller	Weight [g/m]	Part #
	Gray ≈ RAL 7042	775.0	6XPR28F72.2000
ESD	Black	815.0	6XPR28F91ESD.2000

ROLLER TRACK XST H26

MODEL	Assembled ready for use
DESCRIPTION	Economical, resilient and smooth running roller track XST H26
MATERIAL	Roller track profile XST: Steel Standard roller: Plastic PP ESD electrostatically discharging roller: Plastic PP, electrostatically discharging Axle: Steel
COLOR	Black, gray
PACK QUANTITY	12 pieces at 2000 mm
SPECIALS	Other colors on request

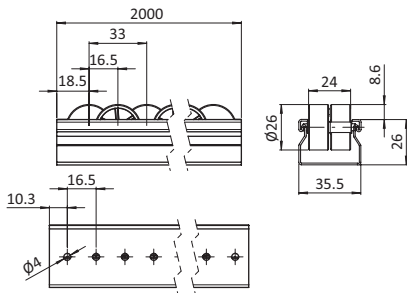

ESD	Color of Roller	Weight [g/m]	Part #
	Gray ≈ RAL 7042	834.0	6XPH2672.2000
ESD	Black	882.0	6XPH2691ESD.2000

GUIDING RAIL XST LATERAL

MODEL	For roller tracks XST
DESCRIPTION	For a safe guiding and positioning in flexible conveyor facilities, guiding rails provide for an adequate work height for the product supply
MATERIAL	Standard version: Plastic PVC ESD electrostatical discharging version: Plastic PVC, carbon fiber reinforced
COLOR	Black, gray
PACK QUANTITY	12 meters (6 pieces at 2 m)
SPECIALS	Other colors on request

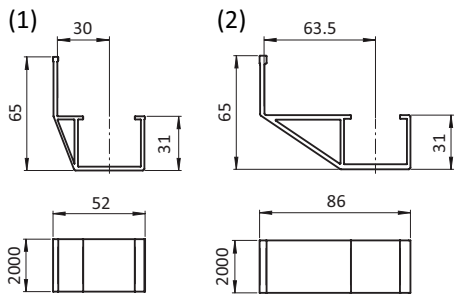

Fig.	Version	ESD	Color	Weight [g/m]	Part #
①	Lateral 30		Black	600.0	062MGRL3291.2000
①	Lateral 30	ESD	Black	600.0	062MGRL3291ESD.2000
①	Lateral 30		Gray ≈ RAL 7042	600.0	062MGRL3274.2000
②	Lateral 63.5		Black	800.0	062MGRL6591.2000
②	Lateral 63.5	ESD	Black	800.0	062MGRL6591ESD.2000
②	Lateral 63.5		Gray ≈ RAL 7042	800.0	062MGRL6574.2000

GUIDING RAIL XST CENTRAL

MODEL	For roller tracks XST
DESCRIPTION	For a safe guiding and positioning in flexible conveyor facilities, guiding rails provide for an adequate work height for the product supply
MATERIAL	Standard version: Plastic PVC ESD electrostatical discharging version: Plastic PVC, carbon fiber reinforced
COLOR	Black, gray
PACK QUANTITY	12 meters (6 pieces at 2 m)
SPECIALS	Other colors on request
TIP	Compatible brackets for XST roller tracks see 062MHD28M, 062MHD30M



ESD	Color	Weight [g/m]	Part #
	Black	485.0	062MGRC91.2000
ESD	Black	430.0	062MGRC91ESD.2000
	Gray ≈ RAL 7042	485.0	062MGRC74.2000

HOLDING BRACKET ST / XST D28

MODEL	for roller tracks XST
DESCRIPTION	To mount roller tracks XST and guiding rails XST central to tubular frame profiles with Ø 28 mm outer diameter, preventing inserts from slipping out
MATERIAL	Steel
SURFACE	Zinc plated
FASTENING	With 3 self-drilling screws DIN 7504 Form N - 3.9 x 16
PACK QUANTITY	10 pieces
SPECIALS	Other surfaces, other colors on request

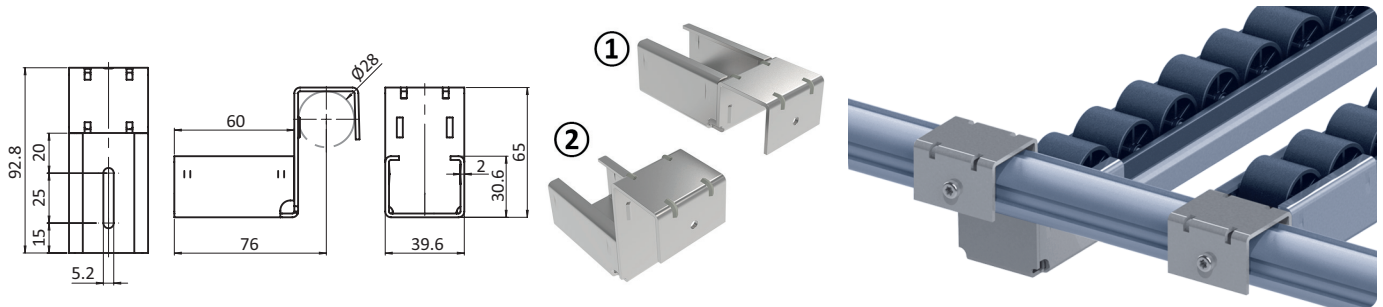

Fig.	Version	Weight [g]	Part #
①	Without end stop	135.8	062MHD28M
②	With end stop	156.1	062MHS28M

HOLDING BRACKET ST / XST D30

MODEL	for roller tracks XST
DESCRIPTION	To mount roller tracks XST and guiding rails XST central to tubular frame profiles with \varnothing 30 mm outer diameter, preventing inserts from slipping out
MATERIAL	Steel
SURFACE	Zinc plated
SET	5 self-drilling screws DIN 7504 Form N - 3.9 x 16
PACK QUANTITY	10 set
SPECIALS	Other surfaces, other colors on request

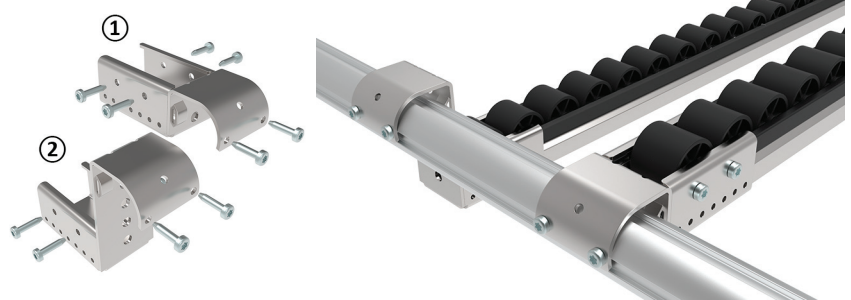
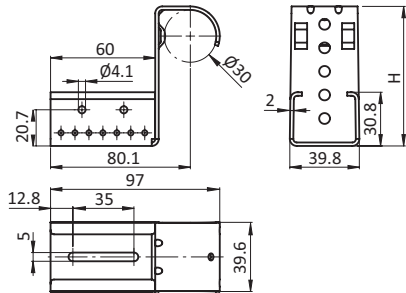

Fig.	Version	H [mm]	Weight [g]	Part #
①	Without end stop	30.8	161.0	062MHD30MS01
②	With end stop	65.5	171.0	062MHSD30MS03
②	With end stop	80.0	173.0	062MHSD30MS01

VARIABLE HOLDING BRACKET ST / XST D28

MODEL	for roller tracks XST
DESCRIPTION	Transition between roller tracks with varying inclination, to mount roller tracks XST and guiding rails XST central, at different angles, to tubular frame profiles with Ø 28 mm outer diameter, preventing inserts from slipping out
MATERIAL	Steel
SURFACE	Zinc plated
FASTENING	With 3 or 4 self-drilling screws DIN 7504 Form N - 3.9 x 16
PACK QUANTITY	10 pieces
SPECIALS	Other surfaces, other colors on request

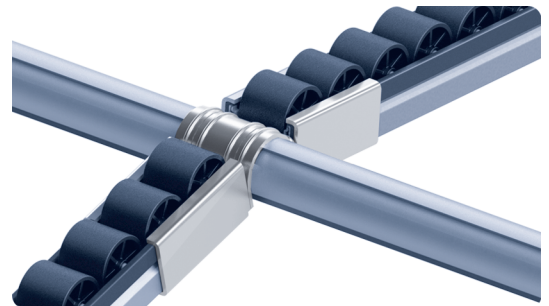
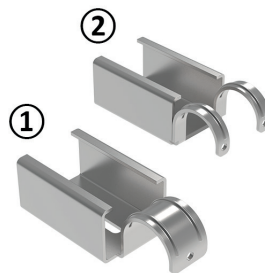
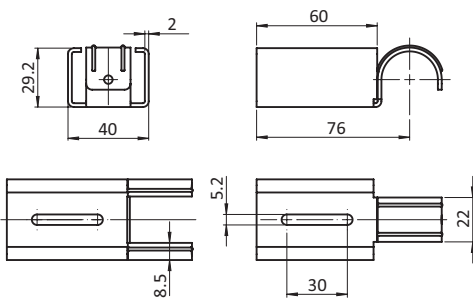

Fig.	Version	Weight [g]	Part #
①	Typ M	106.0	062MYMD28M
②	Typ F	103.0	062MYFD28M

VARIABLE HOLDING BRACKET ST / XST D30

MODEL	for roller tracks XST
DESCRIPTION	Transition between roller track profiles with varying inclination, to mount roller track profiles XST and guiding rails XST central at different angles to tubular frame profiles with Ø 30 mm outer diameter, preventing inserts from slipping out
MATERIAL	Steel
SURFACE	Zinc plated
FASTENING	with 5 or 6 self-drilling screws DIN 7504 Form N - 3.9 x 16
PACK QUANTITY	10 set
SPECIALS	Other surfaces, other colors on request

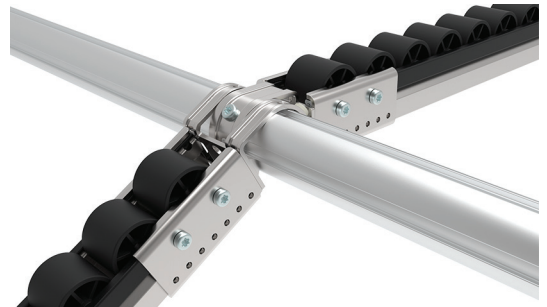
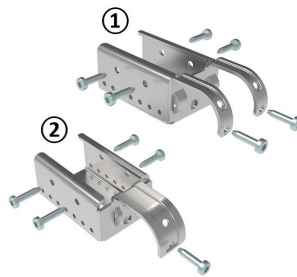
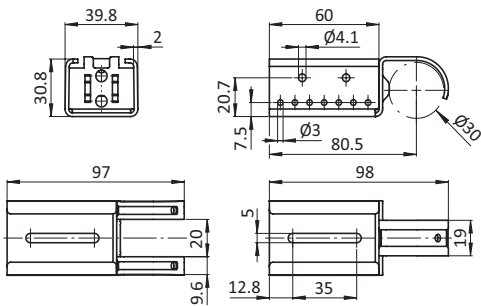
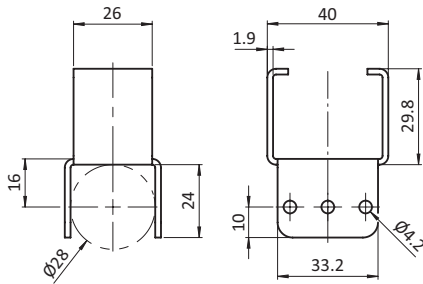

Fig.	Version	Weight [g]	Part #
②	Typ M	145.0	062MYMD30MS01
①	Typ F	150.0	062MYFD30MS01

MOUNTING BRACKET ST / XST D28

MODEL	For roller tracks XST
DESCRIPTION	To mount and support an roller track XST or a guiding rail XST central on a crossing tubular frame profile with Ø 28 mm outer diameter
MATERIAL	Steel
SURFACE	Zinc plated
ASSEMBLY SET	2 self-drilling screws DIN 7504 Form N - 3.9 x 16
PACK QUANTITY	10 pieces / 10 set
SPECIALS	Other surfaces, other colors on request



Version	Weight [g]	Part #
	64.0	062MMD28M
With assembly set	68.0	062MMD28MS01

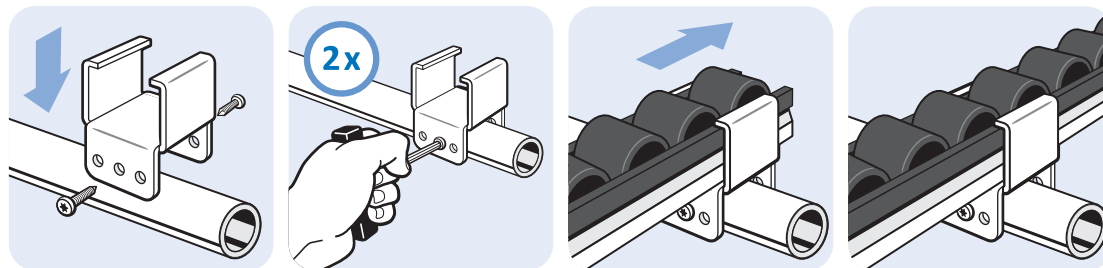

MOUNTING BRACKET ST / XST D30

MODEL	For XST roller tracks
DESCRIPTION	To mount and support an roller track XST or a guiding rail XST central on a crossing tubular frame profile with \varnothing 30 mm outer diameter
MATERIAL	Steel
SURFACE	Zinc plated
ASSEMBLY SET	4 self-drilling screws DIN 7504 Form N - 3,9 x 16
PACK QUANTITY	10 set
SPECIALS	Other surfaces, other colors on request

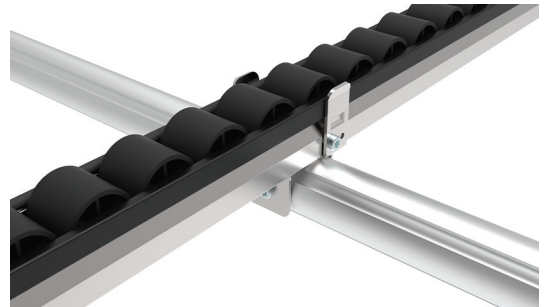
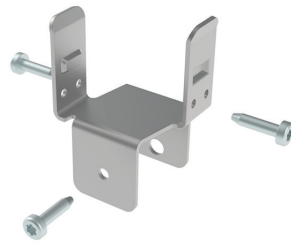
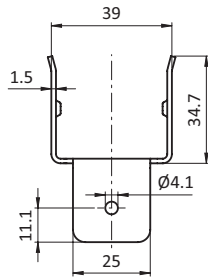
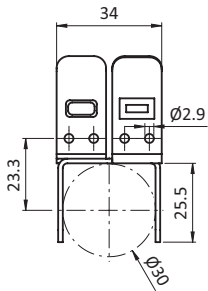

Weight [g]

Part #

46.0

062MMD30MS01

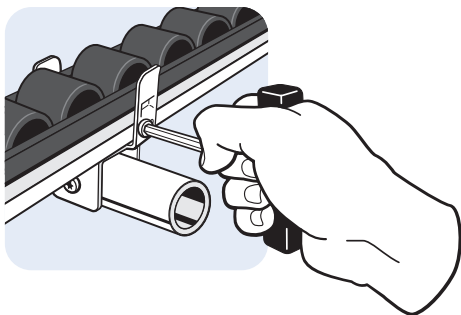
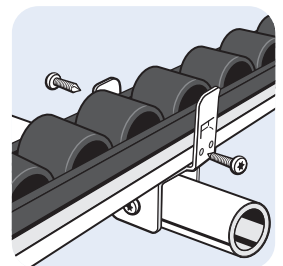
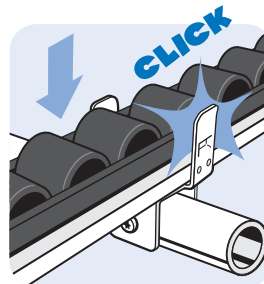
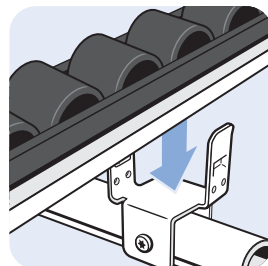
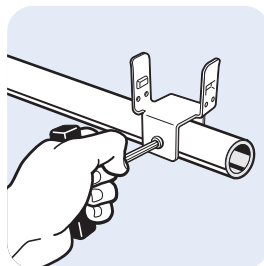
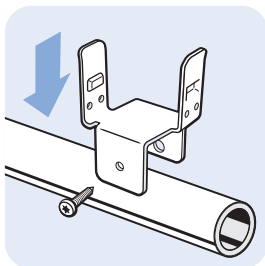

PART NUMBER INDEX

020		02012A7M	40	02013T13593	33	02021E60100SA63	66
02011A1/3A15	19	02012ASA	37	02021E37105LA15	58	02021E60100SA93	66
02011A1/3A31	19	02012ECA	39	02021E37105LA31	58	02021E60100SM15	67
02011A1/3A55	19	02012ECH	38	02021E37105LA55	58	02021E60100SM31	67
02011A1/3A63	19	02012ECM	40	02021E37105LA63	58	02021E60100SM55	67
02011A1/3H15	16	02013S6701	34	02021E37105LA91	58	02021E60100SM63	67
02011A1/3H31	16	02013S6715	34	02021E37105LA93	58	02021E60100SM93	67
02011A1/3H55	16	02013S6731	34	02021E37105LM15	60	02021E60200SA15	66
02011A1/3H63	16	02013S6755	34	02021E37105LM31	60	02021E60200SA31	66
02011A1/3M15	22	02013S6763	34	02021E37105LM55	60	02021E60200SA55	66
02011A1/3M31	22	02013S6775	34	02021E37105LM63	60	02021E60200SA63	66
02011A1/3M55	22	02013S6791	34	02021E37105LM91	60	02021E60200SA93	66
02011A1/3M63	22	02013S6793	34	02021E37105LM93	60	02021E60200SM15	67
02011A4PA15	20	02013S8501	35	02021E37105TA15	62	02021E60200SM31	67
02011A4PA31	20	02013S8515	35	02021E37105TA31	62	02021E60200SM55	67
02011A4PA55	20	02013S8531	35	02021E37105TA55	62	02021E60200SM63	67
02011A4PA63	20	02013S8555	35	02021E37105TA63	62	02021E60200SM93	67
02011A4PH15	17	02013S8563	35	02021E37105TA91	62	02021E60300SA15	66
02011A4PH31	17	02013S8575	35	02021E37105TA93	62	02021E60300SA31	66
02011A4PH55	17	02013S8591	35	02021E37105TM15	64	02021E60300SA55	66
02011A4PH63	17	02013S8593	35	02021E37105TM31	64	02021E60300SA63	66
02011A4PM15	23	02013S13501	36	02021E37105TM55	64	02021E60300SA93	66
02011A4PM31	23	02013S13515	36	02021E37105TM63	64	02021E60300SM15	67
02011A4PM55	23	02013S13531	36	02021E37105TM91	64	02021E60300SM31	67
02011A4PM63	23	02013S13555	36	02021E37105TM93	64	02021E60300SM55	67
02011A5LA15	18	02013S13563	36	02021E50105LA15	59	02021E60300SM63	67
02011A5LA31	18	02013S13575	36	02021E50105LA31	59	02021E60300SM93	67
02011A5LA55	18	02013S13591	36	02021E50105LA55	59	02021H20075A01	48
02011A5LA63	18	02013S13593	36	02021E50105LA63	59	02021H20075M01	53
02011A5LH15	15	02013T6701	31	02021E50105LA91	59	02021H20100A01	48
02011A5LH31	15	02013T6715	31	02021E50105LA93	59	02021H20100M01	53
02011A5LH55	15	02013T6731	31	02021E50105LM15	61	02021H20150A01	48
02011A5LH63	15	02013T6755	31	02021E50105LM31	61	02021H20150M01	53
02011A5LM15	21	02013T6763	31	02021E50105LM55	61	02021H27075A01	49
02011A5LM31	21	02013T6775	31	02021E50105LM63	61	02021H27075M01	54
02011A5LM55	21	02013T6791	31	02021E50105LM91	61	02021H27100A01	49
02011A5LM63	21	02013T6793	31	02021E50105LM93	61	02021H27100M01	54
02011E02	24	02013T8501	32	02021E50105TA15	63	02021H27150A01	49
02011E03	25	02013T8515	32	02021E50105TA31	63	02021H27150M01	54
02011E04	26	02013T8531	32	02021E50105TA55	63	02021H38075A01	50
02011E05	27	02013T8555	32	02021E50105TA63	63	02021H38075M01	55
02012A1/4A	39	02013T8563	32	02021E50105TA91	63	02021H38100A01	50
02012A1/4H	38	02013T8575	32	02021E50105TA93	63	02021H38100M01	55
02012A1/4M	40	02013T8591	32	02021E50105TM15	65	02021H38150A01	50
02012A5A	39	02013T8593	32	02021E50105TM31	65	02021H38150M01	55
02012A5H	38	02013T13501	33	02021E50105TM55	65	02021H47100A01	51
02012A5M	40	02013T13515	33	02021E50105TM63	65	02021H47100M01	56
02012A6A	39	02013T13531	33	02021E50105TM91	65	02021H47150A01	51
02012A6H	38	02013T13555	33	02021E50105TM93	65	02021H47150M01	56
02012A6M	40	02013T13563	33	02021E60100SA15	66	02021H67100A01	52
02012A7A	39	02013T13575	33	02021E60100SA31	66	02021H67100M01	57
02012A7H	38	02013T13591	33	02021E60100SA55	66	02021H67200A01	52

PART NUMBER INDEX

02021H67200M01	57	0203SP05	101	02041A375	136	02065WA415	183
02021N35G	163	0203SP06	102	02041A391	136	02065WA431	183
02021N45G	163	0203SW01	111	02041A393	136	02065WA455	183
02021N75G	163	0203SW02	112	02041A415	135	02065WA475	183
0203HF09015	90	0203SW03	113	02041A455	135	0207D1F2S2WD004	198
0203HF09031	90	0203T05015	77	02041A463	135	0207D1F2S2WDS02	198
0203HF09055	90	0203T05031	77	02041A475	135	0207D1F2S2WDS03	198
0203HF09063	90	0203T05055	77	02041A491	135	0207D1SF2S2WDS03	198
0203HF09093	90	0203T05056	77	02041A493	135	0207D1SS4WDS02	197
0203HI05015	87	0203T05063	77	02042AT	143	0207D1SS4WDS03	197
0203HI05031	87	0203T05093	77	02042CC	137	0207D1SS4WDS04	197
0203HI05055	87	0203T07515	78	02042CM	145	02081AHH.0400	217
0203HI05063	87	0203T07531	78	02042HH	138	02081AHH.0800	217
0203HI05093	87	0203T07555	78	02042KC	144	02081AHH.1200	217
0203HI07515	88	0203T07563	78	02042MH	142	02081AHH.2400	217
0203HI07531	88	0203T07593	78	02042PC	141	02081ALH.0400	216
0203HI07555	88	0203T10015	79	02042SE	139	02081ALH.0800	216
0203HI07563	88	0203T10056	79	02042SH	140	02081ALH.1200	216
0203HI07593	88	0203T10093	79	02051A4LS01	162	02081ALH.2400	216
0203HI10093	89	0203T0501591	77	02051A4PS01	162	02081ALL.0400	215
0203HL05015	85	0203T0503193	77	02051A5LS01	162	02081ALL.0800	215
0203HL05031	85	0203TT05015	80	02051A5PS01	162	02081ALL.1200	215
0203HL05055	85	0203TT05031	80	02052A1/375	158	02081ALL.2400	215
0203HL05063	85	0203TT05055	80	02052A4P75	159	02082BB	232
0203HL05093	85	0203TT05065	80	02052A5L75	157	02082CCS01	227
0203HL07515	86	0203TT05093	80	02052E02A1-3R01	161	02082CCS02	249
0203HL07531	86	0203TT0503193	80	02052E02A4A5PR01	161	02082D	230
0203HL07555	86	0203TT0509115	80	02052E02AR02	161	02082ES	233
0203HL07563	86	0203WRA1/215	94	02052E03A1-301	160	02082FS	229
0203HL07593	86	0203WRA1/231	94	02052E03A4P	160	02082P.1200	226
0203HT05015	83	0203WRA1/255	94	02052E03A5L	160	02082P.1800	226
0203HT05031	83	0203WRA1/263	94	02052E04A1-301	160	02082P.2400	226
0203HT05055	83	0203WRA1/293	94	02052E04A4P	160	02082PO.1200	248
0203HT05063	83	0203WRA1/315	92	02052E04A5L	160	02082PO.1800	248
0203HT05093	83	0203WRA1/331	92	0206BM31	178	02082PO.2400	248
0203HT07515	84	0203WRA1/355	92	0206BM55	178	02082S.15	228
0203HT07531	84	0203WRA1/363	92	0206BM63	178	02084HHS01	220
0203HT07555	84	0203WRA1/393	92	0206BM91	178	02084HHXLS01	222
0203HT07563	84	0203WRA415	93	0206FP91	180	02084LHS01	219
0203HT07593	84	0203WRA431	93	0206U74	177	02084LHXLS01	221
0203SM01	103	0203WRA455	93	0206U200CS	179	02084LLS01	218
0203SM02	104	0203WRA456	93	020611000	171	02084R01	220
0203SM03	105	0203WRA463	93	020612000	171	02084R01	222
0203SM04	106	0203WRA493	93	020631000M	172	02084S.15	223
0203SM05	107	0203WRA515	91	020632000M	172	0209SM01	121
0203SM06	108	0203WRA531	91	02063L1500M	173	0209SM02	122
0203SM07	109	0203WRA555	91	02064A3N0874	146	0209SM03	123
0203SM08	110	0203WRA563	91	020640SN0874	146	0209SM04	124
0203SP01	97	0203WRA593	91	02065WA315	184	0209SM05	125
0203SP02	98	02041A315	136	02065WA331	184	0209SP01	119
0203SP03	99	02041A355	136	02065WA355	184	0209SP02	120
0203SP04	100	02041A363	136	02065WA375	184	0209SW01	126

PART NUMBER INDEX

061		092		093WS30145S01	252
061FGB40LN08	150	092050	251	093WS30145S02	253
061FGB80HN08	151	092050A	251	093WS40145N08	235
061FGL40LN08	150	092050AS01	251	093WS40145N08R	235
061FGL80HN08	151	092050S07	251	093WS40545N08S01	236
061FGM40LN08	150	092050S12	251		
061FGM80HN08	151	092050S14	251	096	
061FGN40LN08	150	092054	251	096010S11	250
061FGN80HN08	151	092080	234	096023	247
061FGS40LN08	150	092080A	234	096024	247
061FGS80HN08	151	092080S02	234	096025	247
061FGZ40LN08	150	092080S03	234	096026	247
061FGZ80HN08	151	092081	234	096028	247
061KH300N0874.650	191			096060S02	231
		093		096314F	260
062		093VAD28V	149	096315F	260
062MGRC74.2000	270	093VAD28V	262	096316F	260
062MGRC91.2000	270	093VAD30V	263	096318F	260
062MGRC91ESD.2000	270	093VAD30VS01	263		
062MGRL3274.2000	269	093VM4080LN08	245	099	
062MGRL3291.2000	269	093VM120120LN08	246	099D0830M0515	255
062MGRL3291ESD.2000	269	093W02	257	099D0840M0530	239
062MGRL6574.2000	269	093W02	259	099DC084040N08	148
062MGRL6591.2000	269	093W302	259	099E40400808AS01	240
062MGRL6591ESD.2000	269	093W302N08	259	099E40400808RS01	240
062MHD28M	271	093W302N08S01	259	099E40800808AS01	240
062MHD30MS01	272	093W302N08S04	259	099E40800808AS02	240
062MHSD28M	271	093W302N08S05	259	099E40800808RS01	240
062MHSD30MS01	272	093W303	257	099E40800808RS02	240
062MHSD30MS03	272	093W303N08	257	099EA30300808AS01	256
062MMD28M	275	093W303N08S09	257	099EA30300808RS01	256
062MMD28MS01	275	093W303N08S11	257	099G081	237
062MMD30MS01	276	093W303N08S12	257	099G081D40	238
062MYFD28M	273	093W303N08S13	257	099G081D80	238
062MYFD30MS01	274	093W303N08S14	257	099G084	254
062MYMD28M	273	093W401N08	241	099GS081	237
062MYMD30MS01	274	093W401N08R	241	099GS084	254
		093W401N08S03	241	099RV2890LS01	264
2		093W406N08S01	243	099RV3090LS02	261
2PI20080M4.1200MB	202	093W802N08	242	099RVAP40S01	265
2PI20080M4.1200ME	202	093W802N08R	242	099RVAP45S01	265
		093W802N08S02	242		
6		093W809N08S01	244		
6MHM75100D40	186	093WA302	259		
6MHM75100S40	185	093WA303S02	257		
6MHM75100S40IT	189	093WA401	241		
6SHM75100S40IF	188	093WA401S01	241		
6XPH2672.2000	268	093WA406	243		
6XPH2691ESD.2000	268	093WA406S01	243		
6XPR28F72.2000	267	093WA802	242		
6XPR28F91ESD.2000	267	093WA809	244		
6XPR2872.2000	266	093WA809S01	244		
6XPR2891ESD.2000	266				

ALPHABETICAL INDEX

2	
2-sides Open Magnetic Label Envelope 37 - 1.5"	60
2-sides Open Magnetic Label Envelope 50 - 2"	61
2-sides Open Self-adhesive Label Envelope 37 - 1.5"	58
2-sides Open Self-adhesive Label Envelope 50 - 2"	59
A	
Adapter Plate D28 (Set)	265
Adjustable Caster End Stop for Guiding Rail FIFO (Set)	233
Alu Connection Angle 30	257
Alu Connection Angle 30	258
Alu Connection Angle 30 x 60	259
Alu Connection Angle I40 M (Set)	243
Alu Connection Angle I40 x 80 M (Set)	244
Aluminum Tube (Set)	143
Angle Connector 40, 45°	235
Angle Connector I 40, 45° (Set)	236
Attached Visual Pocket 1/3 DIN A4 Portrait - 8.3" x 3.9"	16
Attached Visual Pocket DIN A4 Portrait - 8.3" x 11.7"	17
Attached Visual Pocket DIN A5 Landscape - 8.3" x 5.8"	15
Automatic Connector Steel	237
Automatic Connector Steel	254
Automatic Double Connector I, Slot 8 (Set)	238
B	
Board Marker with Felt Eraser (Set)	178
Brush Brake for Guiding Rail FIFO	232
C	
Caution Forklift Zone Floor Sign	112
Ceiling Magnet with Hook	145
Cleaning Spray for Board Marker	179
Closing Clip	137
Connecting Element for Guiding Rail FIFO (Set)	230
Connecting Strip 140 I, Slot 8 (Set)	231
Connecting Strip 180 B, Slot 8	250
Connection Plate I40 M Length/Cross, Rectangular 2 Hole, 1 Slot (Set)	245
Connection Plate I120 M (Set)	246
Cover Profile Slot 8 - 2.2	251
Cover Profile Slot 8 - 4.5	234
D	
Direct Connector I, Slot 8	148
Disinfect Hands Sticker	123
Dollie for SLC 600 x 400, with 2 Swivel and 2 Fixed Casters	198
Dollie for SLC 600 x 400, with 4 Swivel Casters	197
E	
End Cap for Parking Rail High / High (Set)	220
End Cap for Parking Rail Low / High (Set)	219
End Cap for Parking Rail Low / Low (Set)	218
End Cap XL for Parking Rail High / High (Set)	222
End Cap XL for Parking Rail Low / High (Set)	221
Extrusion Profile Pallet I8	202

ALPHABETICAL INDEX

F	
Face Mask Sticker	121
Face Protection Sticker	122
FIFO Monorail Rail 40	248
Floor Marking Foot Shape 90	90
Floor Marking I-shape 50	87
Floor Marking I-shape 75	88
Floor Marking I-shape 100	89
Floor Marking L-shape 50	85
Floor Marking L-shape 75	86
Floor Marking Tape 50	77
Floor Marking Tape 75	78
Floor Marking Tape 100	79
Floor Marking T-shape 50	83
Floor Marking T-shape 75	84
Floor Window 1/2 DIN A4 Landscape - 11.7" x 4.1"	94
Floor Window 1/3 DIN A4 Portrait - 8.3" x 3.9"	92
Floor Window DIN A4 - 8.3" x 11.7"	93
Floor Window DIN A5 - 5.8" x 8.3"	91
Friction Joint I40L for System Arm (Set)	150
Friction Joint I80H for System Arm (Set)	151
G	
German Drive Slowly Floor Sign "Schritt fahren"	110
Guiding Rail FIFO (Set)	226
Guiding Rail XST Central	270
Guiding Rail XST Lateral	269
H	
Hanging Hook	138
Hard Hat Area Floor Sign	106
Holding Bracket ST / XST D28	271
Holding Bracket ST / XST D30	272
I	
Infeed cap for FIFO Monorail Rail 40 (Set)	249
Infeed Cap for Guiding Rail FIFO (Set)	227
Inserting Box 1/3 DIN A4 Portrait - 8.3" x 3.9"	158
Inserting Box DIN A4 Portrait - 8.3" x 11.7"	159
Inserting Box DIN A5 Landscape - 8.3" x 5.8"	157
K	
KANBAN Clip Document Holder 70 x 30 - 2.8" x 1.2"	37
KANBAN Wall Bracket for Inserting Boxes	161
Keyboard Holder AL, Slot 8 (Set)	191
Knotted Chain	144
L	
Lattice Box Clip for Visual Pocket	25
M	
Magnet for Inserting Systems (Set)	163
Magnetic Document Window DIN A3 - 11.7" x 16.5"	184
Magnetic Document Window DIN A4 - 8.3" x 11.7"	183

ALPHABETICAL INDEX

Magnetic KANBAN Label Holder	40
Magnetic Label Holder 20 - 0.8"	53
Magnetic Label Holder 27 - 1.06"	54
Magnetic Label Holder 38 - 1.5"	55
Magnetic Label Holder 47 - 1.85"	56
Magnetic Label Holder 67 - 2.64"	57
Magnetic Visual Pocket 1/3 DIN A4 Portrait - 8.3" x 3.9"	22
Magnetic Visual Pocket DIN A4 Portrait - 8.3" x 11.7"	23
Magnetic Visual Pocket DIN A5 Landscape - 8.3" x 5.8"	21
Message Frame DIN A3 - 11.7" x 16.5" (Set)	136
Message Frame DIN A4 - 8.3" x 11.7" (Set)	135
Milling Connector B, Slot 8	255
Milling Connector I, Slot 8 (Set)	239
Mobile Enamel Board	172
Mobile Enamel Cube	174
Mobile Whiteboard	173
Monitor Support 4-axis, Height Adjustable (Set)	185
Monitor Support 5-axis, Height Adjustable (Set)	186
Monitor Support 5-axis, Height Adjustable (Set)	187
Monitor Suspension Arm SKY 600, Height Adjustable with Locking (Set)	188
Monitor Work Station SIT / STAND 4-axis, Profile Attachment (Set)	189
Monitor Work Station SIT / STAND 4-axis, Profile Attachment (Set)	190
Monorail Angle Connector for Posts (Set)	252
Monorail Angle Connector for Post Support Struts (Set)	253
Mounting Bracket ST / XST D28	275
Mounting Bracket ST / XST D30	276
Mounting Set Infeed Cap for Guiding Rail FIFO	229
N	
No Entry Floor Sign	99
No Entry Sticker	120
No Forklift Traffic Floor Sign	97
No Handshake Sticker	119
No Pedestrian Floor Sign	101
No Placing or Storing Floor Sign	102
No Smoking Floor Sign	100
No Stopping Floor Sign	98
O	
Organizer UTENSILO, Magnetic (Set)	177
Outer T-Connector D28 (Set)	264
Outer T-Connector D30 - Slot 8 (Set)	261
Overhanging KANBAN Label Holder	38
P	
Parking Rail High / High (Set)	217
Parking Rail Low / High (Set)	216
Parking Rail Low / Low (Set)	215
Pedestrian Route Floor Sign	109
Plastic Pin for Visual Pocket	26
Plastic Tie for Visual Pocket	27
Plate Connector B AL (Set)	256
Plate Connector I ZN 40 (Set)	240

ALPHABETICAL INDEX

Position Marking End Cap for Parking Rail	223
R	
Refill Felt Pad for Eraser, Self-adhesive	180
Roller Track XST H26	268
Roller Track XST R28	266
Roller Track XST R28 mit Spurkranz	267
Roll-in T-slot Nut 11.6 x 4.6 mm with Spring Leaf	260
Roll-in T-slot Nut 13.5 x 7.2 mm with Spring Loaded Ball	247
S	
Safe Distance Sticker	126
Safety Glasses Required Floor Sign	107
Safety Shoes Required Floor Sign	108
Safety Vest Required Floor Sign	104
Screw Cover Infeed Cap for Guiding Rail FIFO	228
Self-adhesive KANBAN Label Holder	39
Self-adhesive Label Holder 20 - 0.8"	48
Self-adhesive Label Holder 27 - 1.06"	49
Self-adhesive Label Holder 38 - 1.5"	50
Self-adhesive Label Holder 47 - 1.85"	51
Self-adhesive Label Holder 67 - 2.64"	52
Self-adhesive Visual Pocket 1/3 DIN A4 Portrait - 8.3" x 3.9"	19
Self-adhesive Visual Pocket DIN A4 Portrait - 8.3" x 11.7"	20
Self-adhesive Visual Pocket DIN A5 Landscape - 8.3" x 5.8"	18
S-hook	140
Side Open KANBAN Envelope 200 x 67 - 7.9" x 2.6"	34
Side Open KANBAN Envelope 200 x 85 - 7.9" x 3.4"	35
Side Open KANBAN Envelope 200 x 135 - 7.9" x 5.3"	36
Side Open Magnetic Label Envelope 60 - 2.4"	67
Side Open Self-adhesive Label Envelope 60 - 2.4"	66
Sign Holder AL (Set)	146
Sign Holder AL (Set)	147
Stop Floor Sign	111
Swivel Loop	139
Swivel Magnet Holder	142
T	
T-connector Plate D28	149
T-connector Plate D28	262
T-Connector Plate D30 (Set)	263
Temporary Floor Marking Tape 50 tesa® 60760	80
Top Open KANBAN Envelope 200 x 67 - 7.9" x 2.6"	31
Top Open KANBAN Envelope 200 x 85 - 7.9" x 3.4"	32
Top Open KANBAN Envelope 200 x 135 - 7.9" x 5.3"	33
Top Open Magnetic Label Envelope 37 - 1.5"	64
Top Open Magnetic Label Envelope 50 - 2"	65
Top Open Self-adhesive Label Envelope 37 - 1.5"	62
Top Open Self-adhesive Label Envelope 50 - 2"	63
Traffic Arrow Floor Sign	105
Traffic Arrow Sticker	125
Tube Clamp	141

ALPHABETICAL INDEX

U	
U-loop Steel Clamp for Visual Pocket	24
V	
Variable Holding Bracket ST / XST D28	273
Variable Holding Bracket ST / XST D30	274
W	
Wall File Pocket	162
Wall-mounted Enamel Board	171
Warning Slippery Surface Floor Sign	113
Wash Hands Sticker	124
Wear Hearing Protection Floor Sign	103
Window for Inserting Boxes	160
Z	
Zinc Connection Angle 40 / 80 flat	242
Zinc Connection Angle 40 flat	241

FATH GmbH | LEAN 4.0 | 05/2022

UPDATE 08.07.2024

FATH GmbH | Gewerbepark Hügelmühle 31, 91174 Spalt, Germany
P: +49 9175 7909-0 | info.de@fath24.com | fath24.com

Managing Directors: Mirko Jan Fath, Wido Fath, Till Zupancic
Trade Register: Amtsgericht Nürnberg, Department B, No. 10906
Place of Execution: 91174 Spalt, Germany
Tax No.: 241/115/40086, VAT No.: DE 133 541 653

© **FATH** GmbH

Reprinting or other duplication, including excerpts, is possible only with the express permission of **FATH** GmbH.
We reserve the right to make technical modifications at any time. All indications are without guarantee. Drawings
and models are the intellectual property of **FATH** GmbH.
Our current Terms and Conditions of Sale, Delivery and Payment apply.

Illustrationen: Andreas Teindl, Dipl. Designer, Illustrator IO

FATH GmbH

Gewerbepark
Hügelmühle 31
91174 Spalt
Germany

P: +49 9175 7909-200
F: +49 9175 7909-29
info.de@fath24.com

FATH Kft.

Gyár u. 2
2040 Budaörs
Hungary

P: +36 23 880-977
F: +36 23 880-978
info.hu@fath24.com

FATH do Brasil Componentes Industriais Ltda

Rodovia Raposo Tavares,
S/N, Km 22,14
Bloco E - 509 Granja Viana
Cotia - SP
06709 - 900
Brazil

P: +55 11 2898-9753
info.br@fath24.com

FATH Inc.

6533 Hazeltine National
Drive, Suite 3
Orlando, FL 32822
USA

P: +1 407 601-5900
F: +1 407 601-5905
info.us@fath24.com

FATH Components Ltd.

6 Pegasus Court, North
Lane
Aldershot
Hampshire
GU12 4QP
Great Britain

P: +44 1252 346610
info.gb@fath24.com

FATH BV

Rudolf Dieselweg 14
5928 RA Venlo
The Netherlands

P: +31 77 333 3555
F: +31 77 333 3550
info.nl@fath24.com

Flowsort BV

De Hooge Akker 18
5661 NG Geldrop
The Netherlands

P: +31 85 076 1339
info.@flow-sort.com

FATH Machine Components Co., Ltd.

Shengang Road No. 2001,
Building 2
201612 Songjiang / Shanghai
PR China

P: +86 21 5774 4520
info.cn@fath24.com

FATH Inc. S.A. de C.V.

Av. Central 230, Int. 140
Los Lermas
67188 Guadalupe, N.L.
Mexico

P: +52 81 3424-1428
info.mx@fath24.com

FATH Schweiz AG

Driesbüelstraße 11
8808 Pfäffikon
Switzerland

P: +41 79 577 61 97
info.ch@fath24.com

Order No. 000315



161612